

arkos

arkowall

PAINÉIS RIPADOS DE POLICARBONATO ESTRUTURAL
PARA FACHADAS E DIVISÓRIAS



Características



100% Policarbonato

Painéis translúcidos de policarbonato estrutural, disponível em diversas cores, perfeitos para projetos de arquitetura com necessidades luminotécnicas específicas. Material de fácil instalação, por encaixe oculto, autoportante e disponível até 11.80 metros de altura.

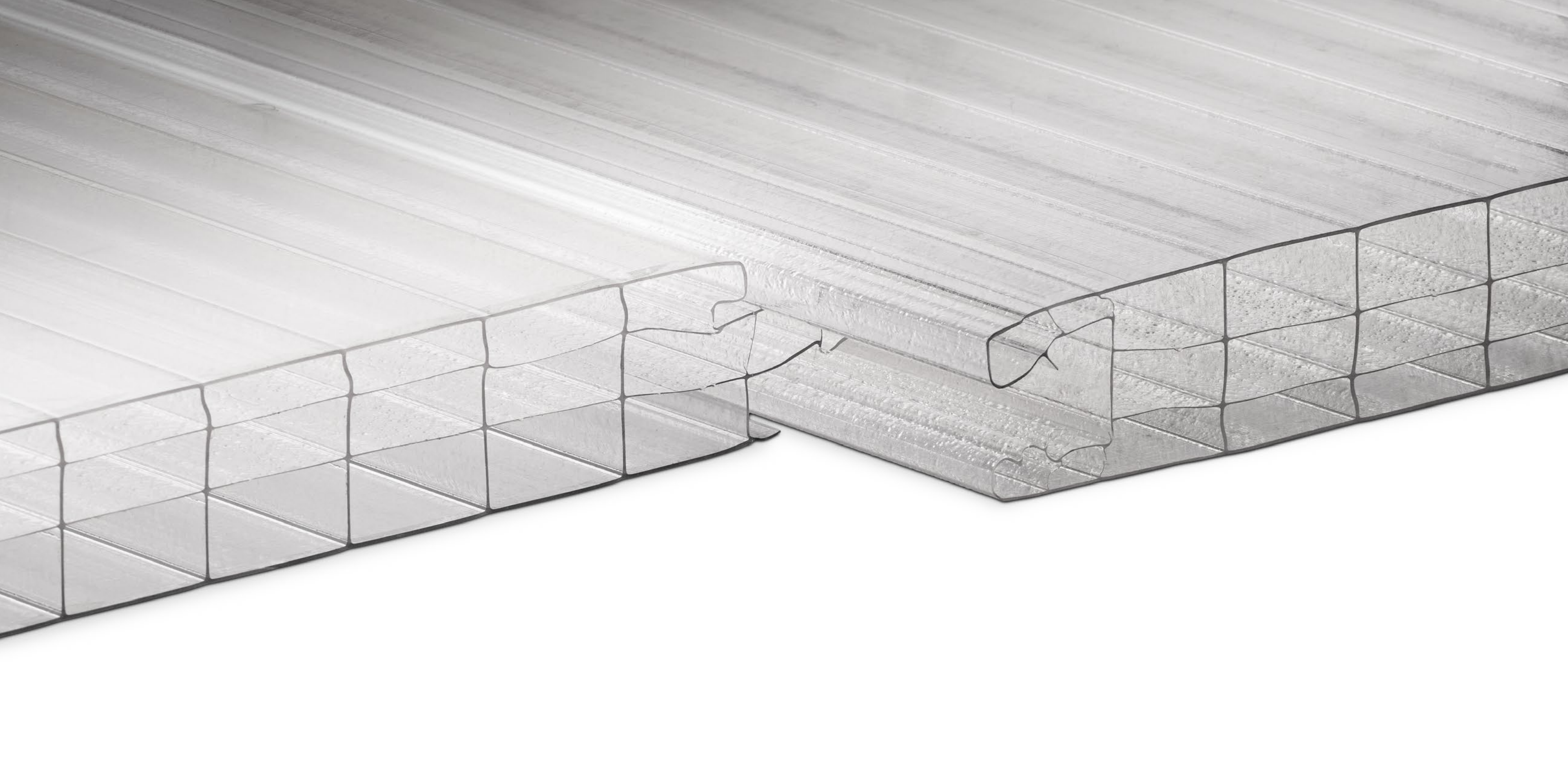

Características

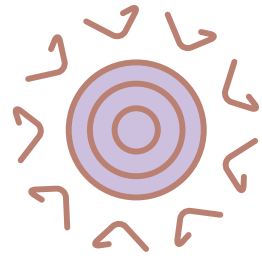

Proteção UV

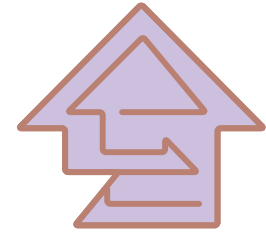

Isolamento térmico

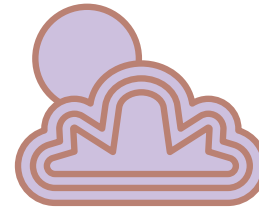

Aplicável em qualquer tipo de
clima e região

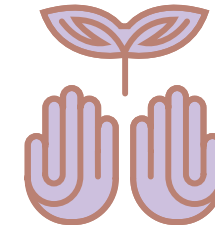

Responsabilidade com
o meio ambiente

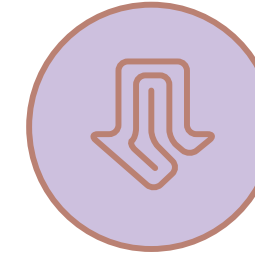

Fácil instalação

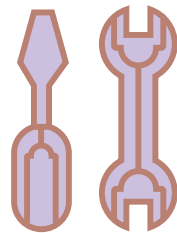

Não requer manutenção

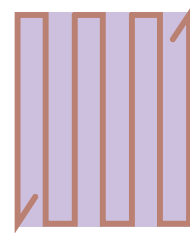

Fachada sustentável

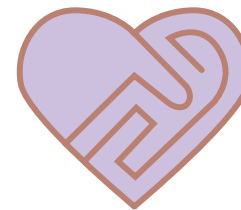

Vida útil de mais de
20 anos



Garantia de 10 anos

Medidas

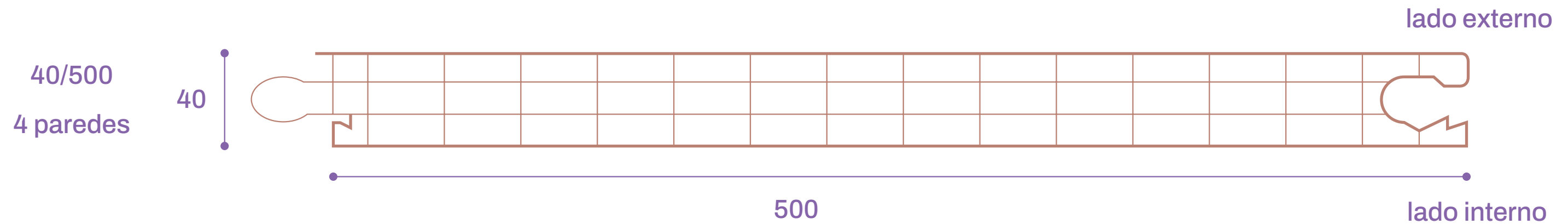

Elementos Acessórios

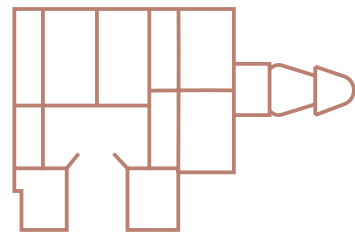

Cantoneira em
policarbonato
R\$ 34/ml

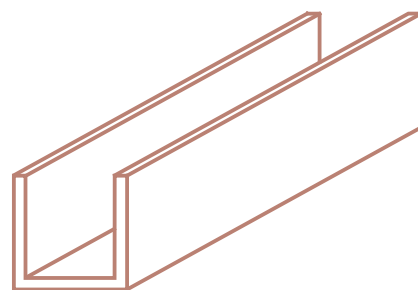

Perfil "U" em aço
galvanizado
para fixação
R\$ 44/ml

Sistema **ARKOWALL** - 40x500mm

Altura máxima disponível: 11,80m

Metro quadrado a partir de R\$574
Para opção fosca R\$663



ARKOWALL

PALETA DE CORES

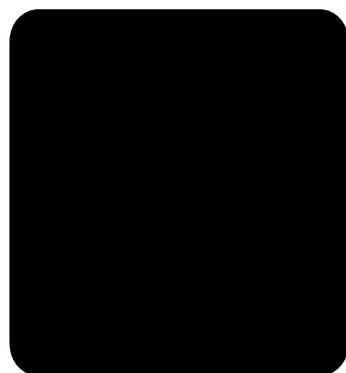

preto



cristal

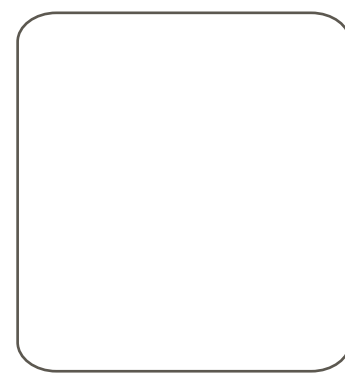

leitoso

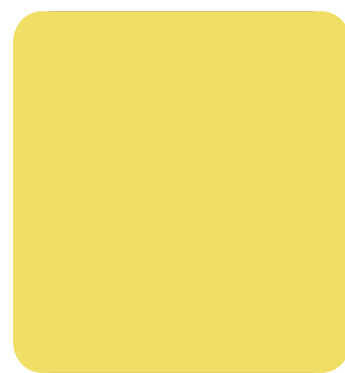

amarelo

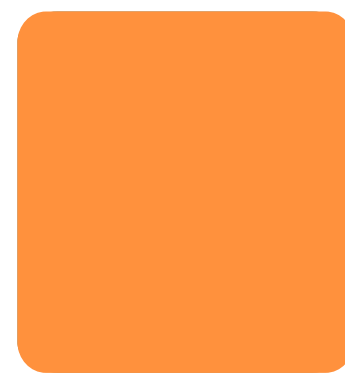

laranja-claro



vermelho



laranja

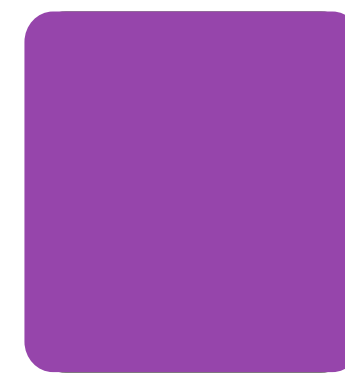

white grey



turquesa



aquamarinha



azul



azul royal



amazonita



jade



esmeralda



verde

A escolha da cor não altera o preço final

ARKOS

arkowall

FACHADAS



Edifício Girassol - FGMF Arquitetos

ARKOWALL CRISTAL

São Paulo, SP





T E M P L E

Zee Dog Temple - Be.Bo.ETC

ARKOWALL BRANCO LEITOSO

São Paulo, SP









LUCENERA

LUCENERA Atelier da Luz- Quintino Facci
Arquitetos

ARKOWALL BRANCO LEITOSO
São Paulo, SP







Convento FFB - Mixtura Studio
ARKOWALL CRISTAL
Salvador, BA





Casacor Paraná - Mariana Paula Souza

ARKOWALL CRISTAL

Paraná, PR









FLORENSE

Florense - Guilherme Torrês
ARKOWALL BRANCO LEITOSO
Porto Alegre, RS



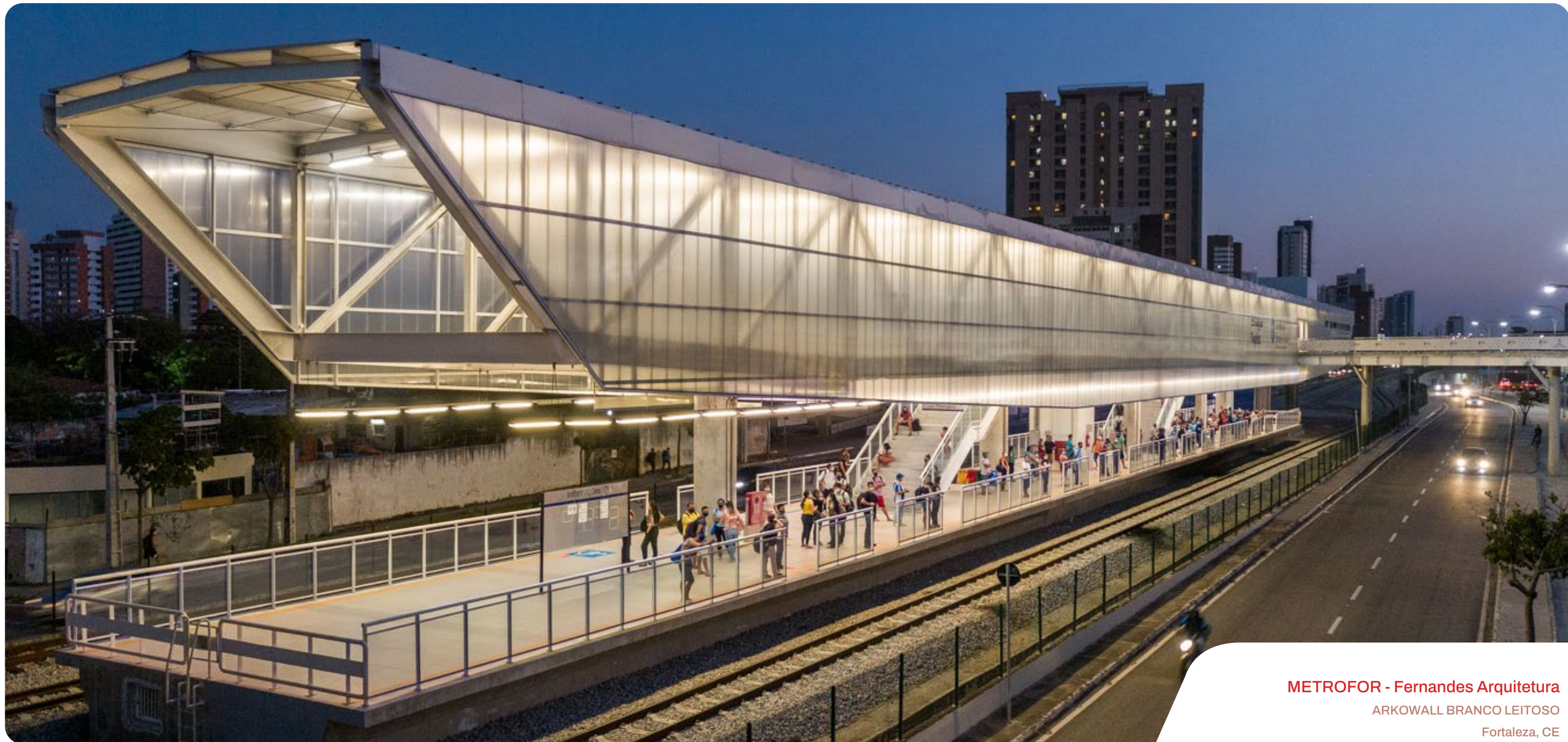

METROFOR - Fernandes Arquitetura

ARKOWALL BRANCO LEITOSO

Fortaleza, CE

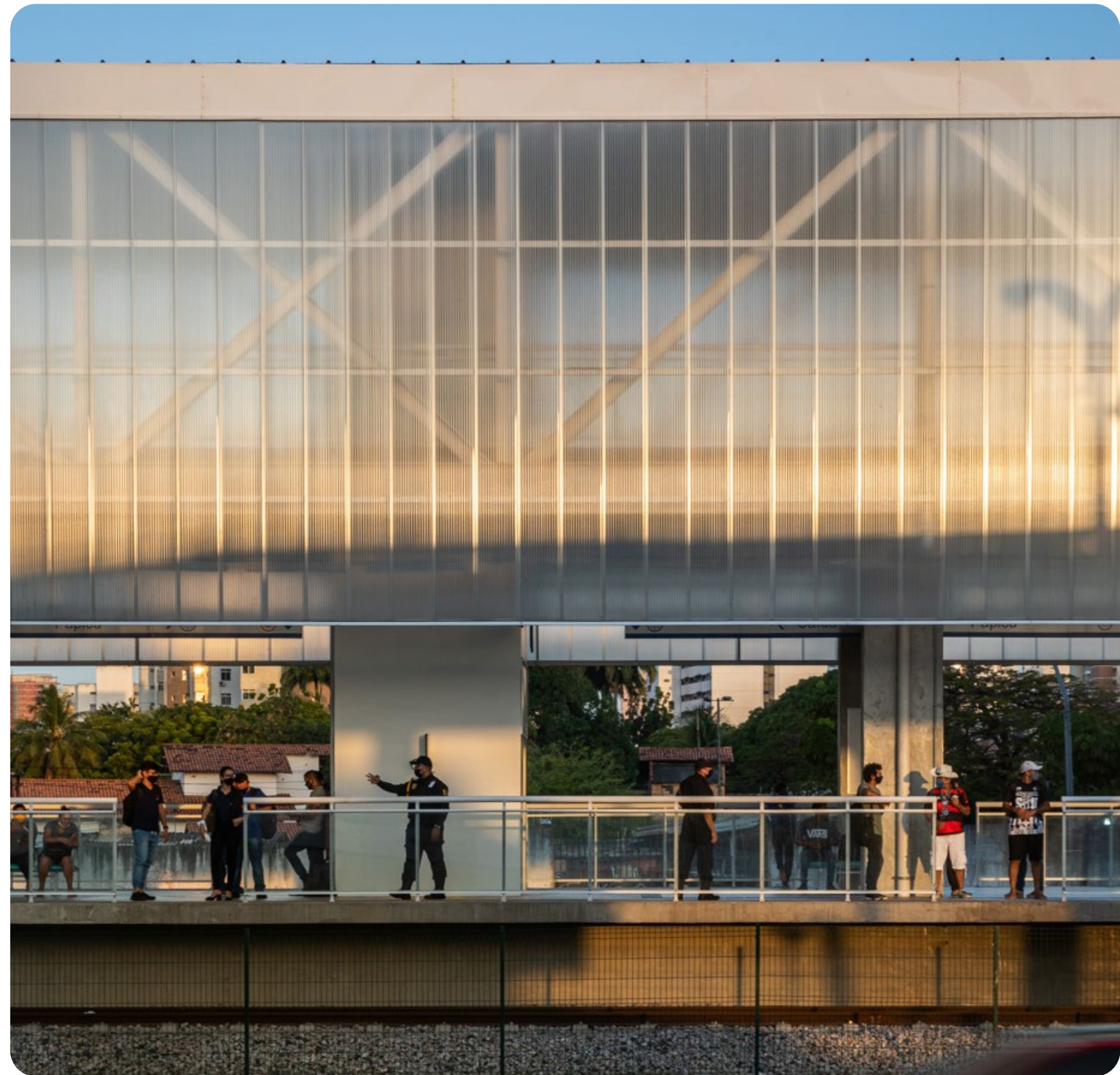



Colégio Miguel de Cervantes - ACR Arquitetura

ARKOWALL BRANCO LEITOSO

São Paulo, SP





DIVINO GALERIA



Divino Galeria - Studio2 Arquitetura e Interiores

ARKOWALL BRANCO LEITOSO

Curitiba, PR



Clube A Hebraica - Bacco Arquitetura
ARKOWALL CRISTAL
São Paulo, SP



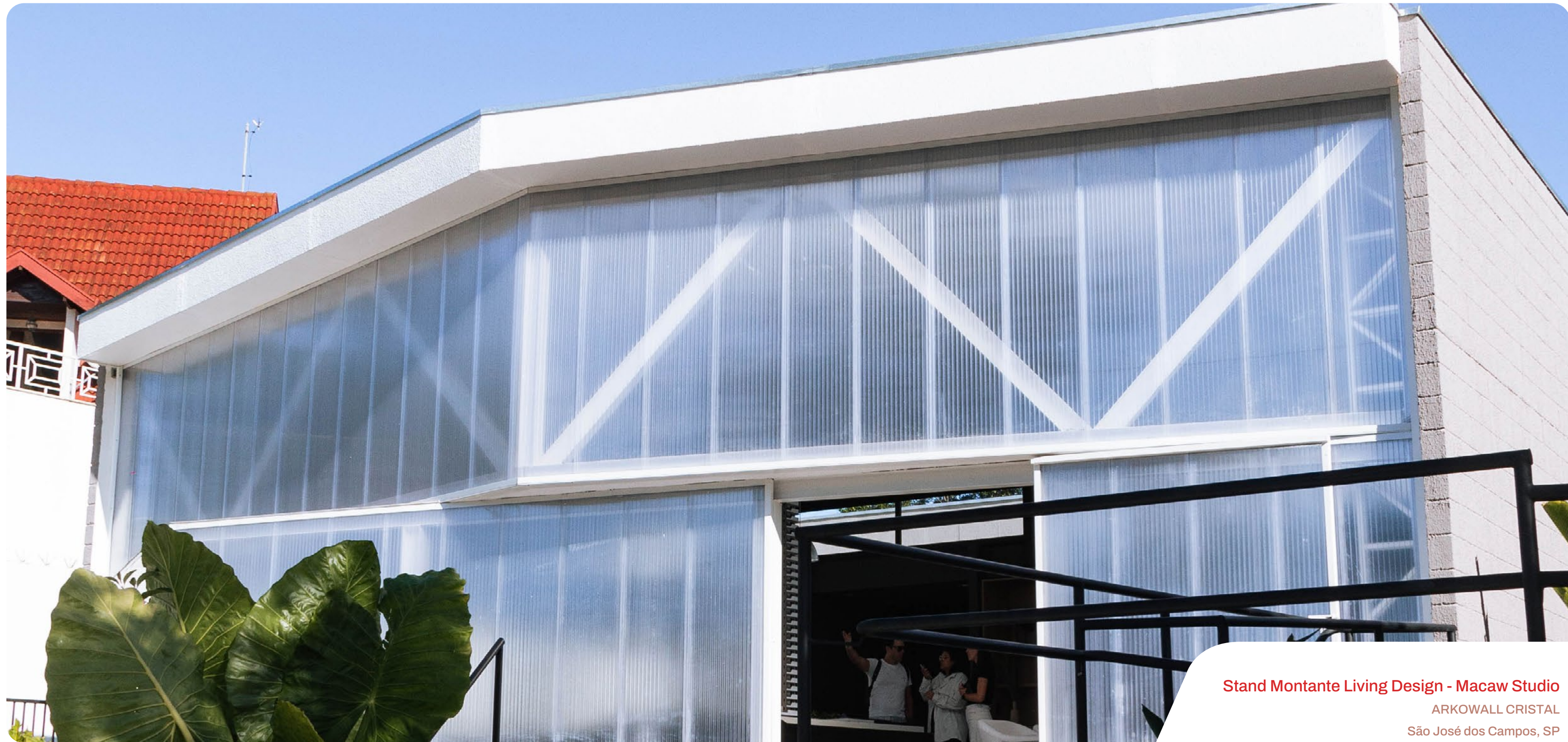

Stand Montante Living Design - Macaw Studio

ARKOWALL CRISTAL
São José dos Campos, SP







Gentil Negócios - Oficina Corporativo
ARKOWALL BRANCO LEITOSO
Natal, RN





Energiluz
design

Deca Portinari ceusa durafloor

ENERGILUZ Design - Marchetti Bonetti

ARKOWALL BRANCO LEITOSO

São José, SC

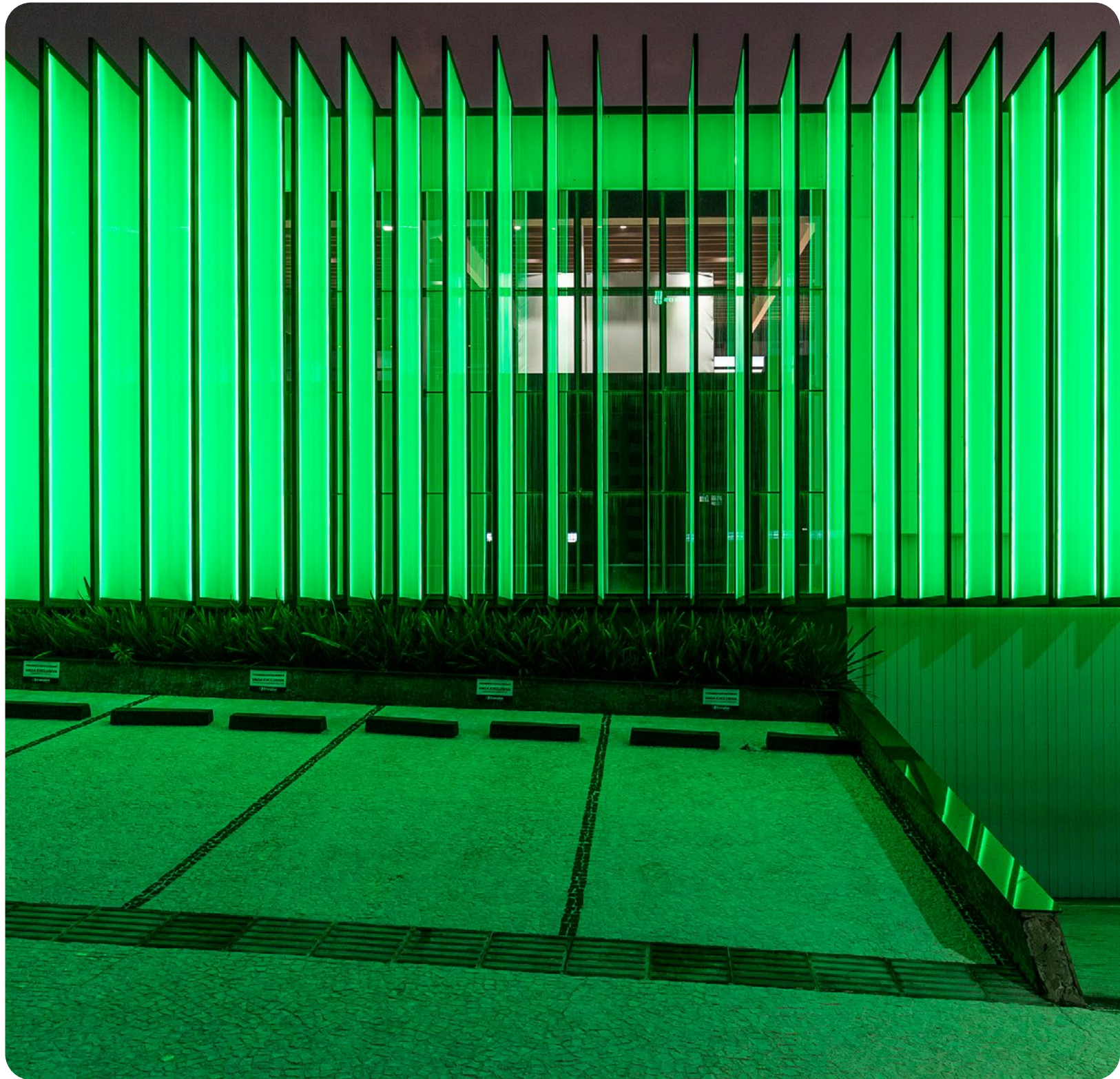



 **Energiluz**
design

design | lighting | acoustics | durafloor



Fundação Florestal - 23SUL
ARKOWALL CRISTAL
Peruíbe, SP







Loja Oficina Interiores
Léo Maia Arquitetos
ARKOWALL BRANCO LEITOSO
João Pessoa, PB





GOWORK.
COWORKING

GoWork Paulista
ARKOWALL CRISTAL
São Paulo, SP

The logo for GOWORK. COWORKING is displayed on a background of vertical, multi-colored stripes. The stripes transition from green at the top, through blue, to red on the left and purple on the right. The logo itself consists of a stylized circular icon on the left, followed by the word "GOWORK." in a large, bold, sans-serif font, and the word "COWORKING" in a smaller, all-caps, sans-serif font below it.

GOWORK.
COWORKING



Loja Líder - Studio Mov Arquitetura
ARKOWALL BRANCO LEITOSO
Goiânia, GO

lider,

lider,

estacionamento



arkowall

DIVISÓRIAS



Clínica Dermatológica Manuela Panteliades

Ângela Roldão Arquitetura

ARKOWALL CRISTAL

Belo Horizonte, MG











**Aeroporto de Confins - Fernandes Arquitetos
Associados**

ARKOWALL BRANCO LEITOSO
São José, SC

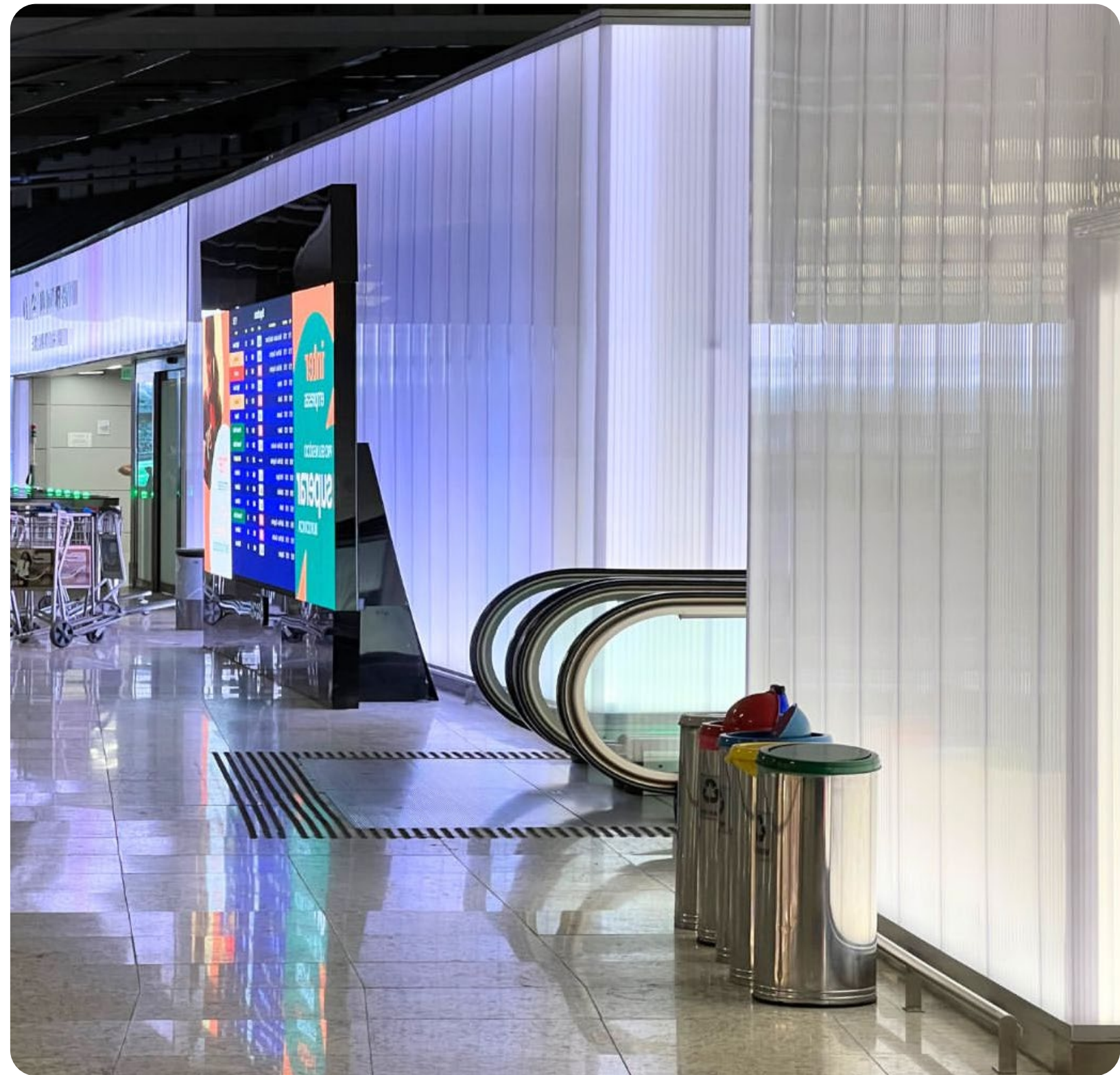

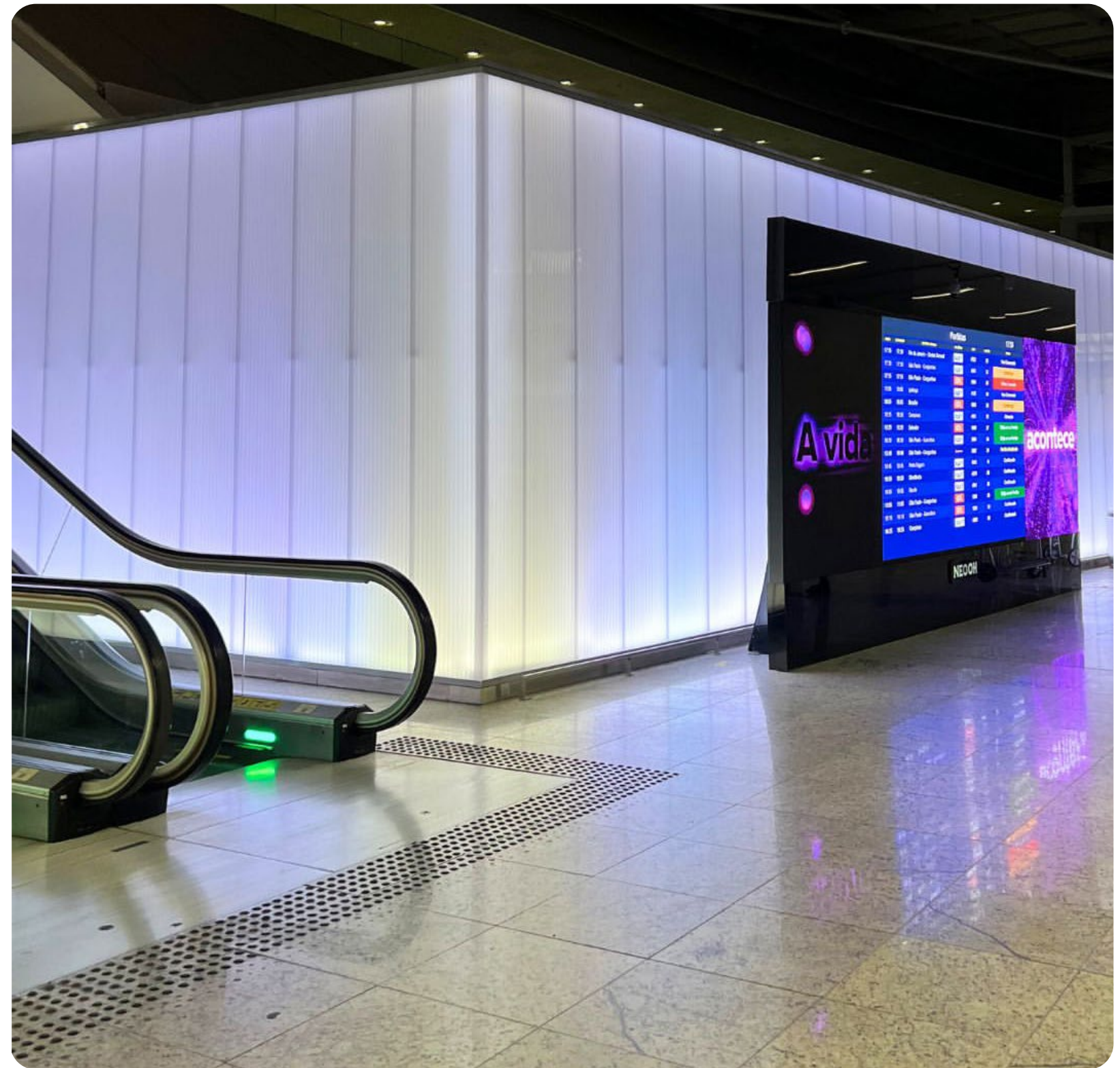



Residência Particular- Cris Furlan Arquitetura

ARKOWALL CRISTAL
Piracicaba, SP





Centro de Tecnologias do Banco Itaú- piratininga
arquitetos associados

ARKOWALL BRANCO LEITOSO
São Paulo, SP





Instituto Abasse - Octaedro Arquitetura

ARKOWALL CRISTAL

São José, SC





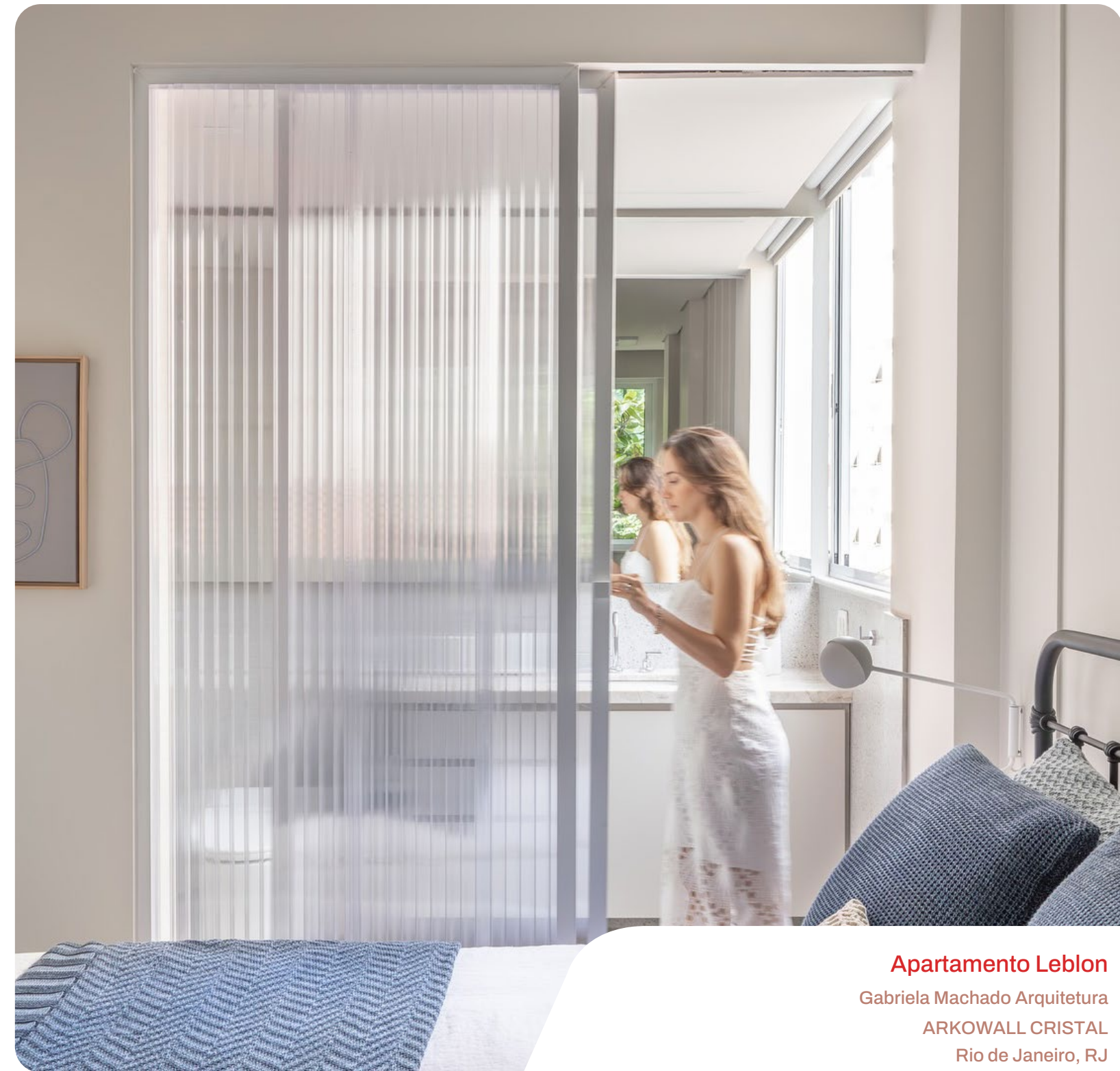

Apartamento Leblon
Gabriela Machado Arquitetura
ARKOWALL CRISTAL
Rio de Janeiro, RJ



Fundação Florestal - 23SUL
ARKOWALL CRISTAL
Peruíbe, SP



EDUCAÇÃO
AMBIENTAL

ALMOXARFARIA



Clínica Dra. Aldrieli - Tropo Arquitetura

ARKOWALL CRISTAL

Curitiba, PR





Escritórios OCA - OCA Arquitetura
ARKOWALL CRISTAL
Porto Alegre, RS







Escritórios Banco Itaú - FGMF Arquitetura

ARKOWALL CRISTAL

São Paulo, SP

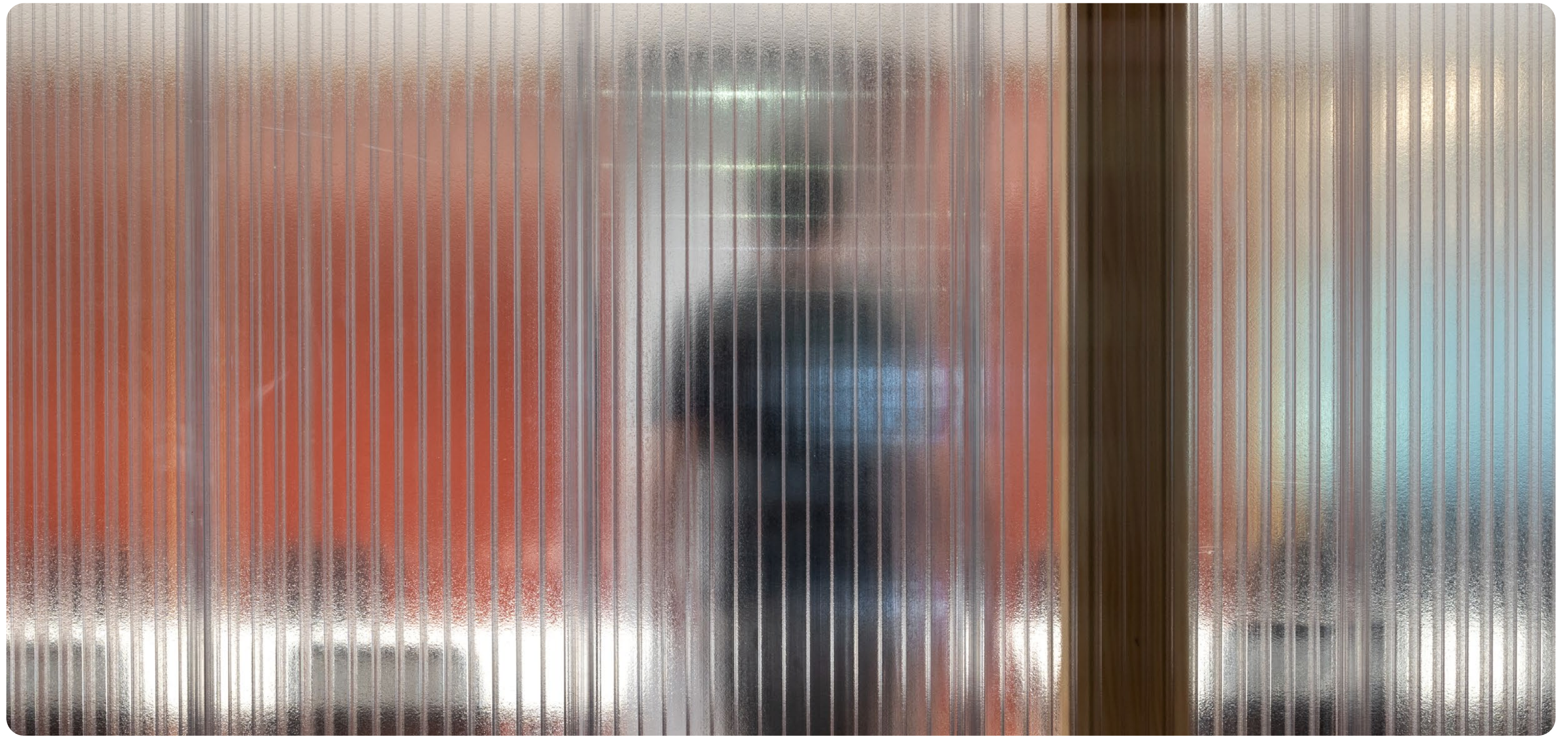







Sala Edifício Taipas

Salamanca Arquitectos
ARKOWALL CRISTAL
Toledo, PR





Camarote MRV - Obvio Arquitetura

ARKOWALL CRISTAL

Belo Horizonte, MG



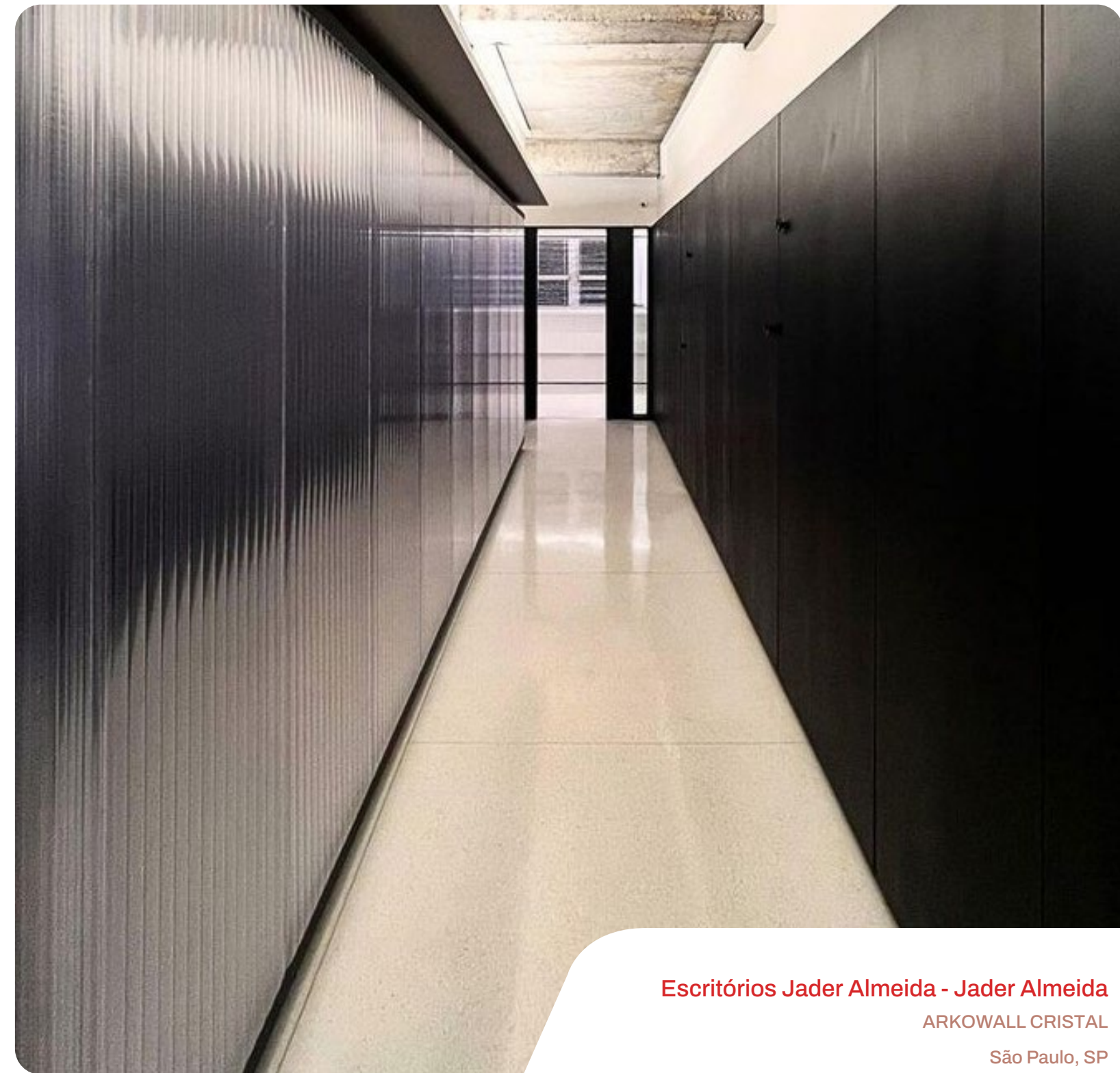

Escritórios Jader Almeida - Jader Almeida
ARKOWALL CRISTAL
São Paulo, SP

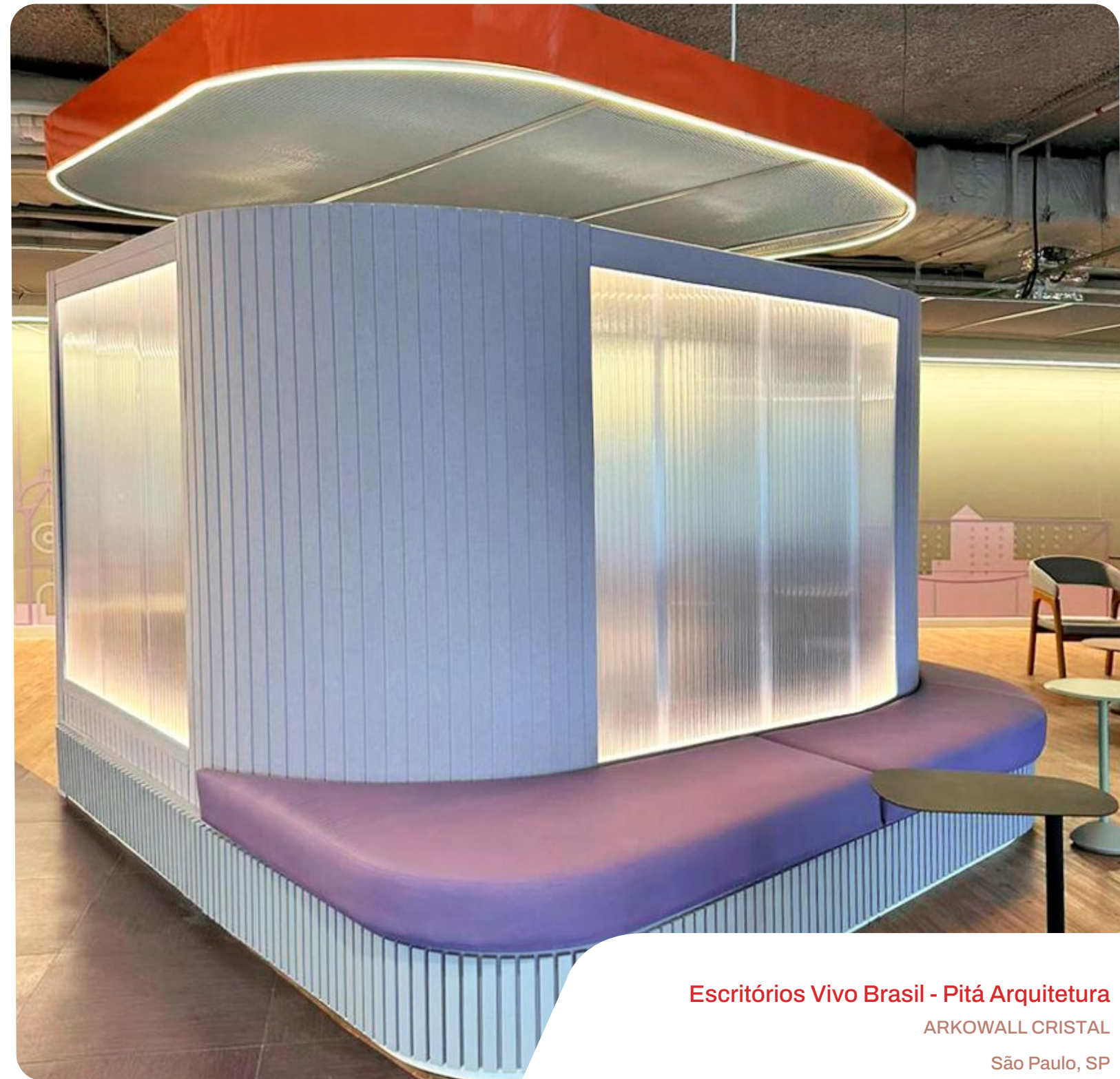

Escritórios Vivo Brasil - Pitá Arquitetura
ARKOWALL CRISTAL
São Paulo, SP

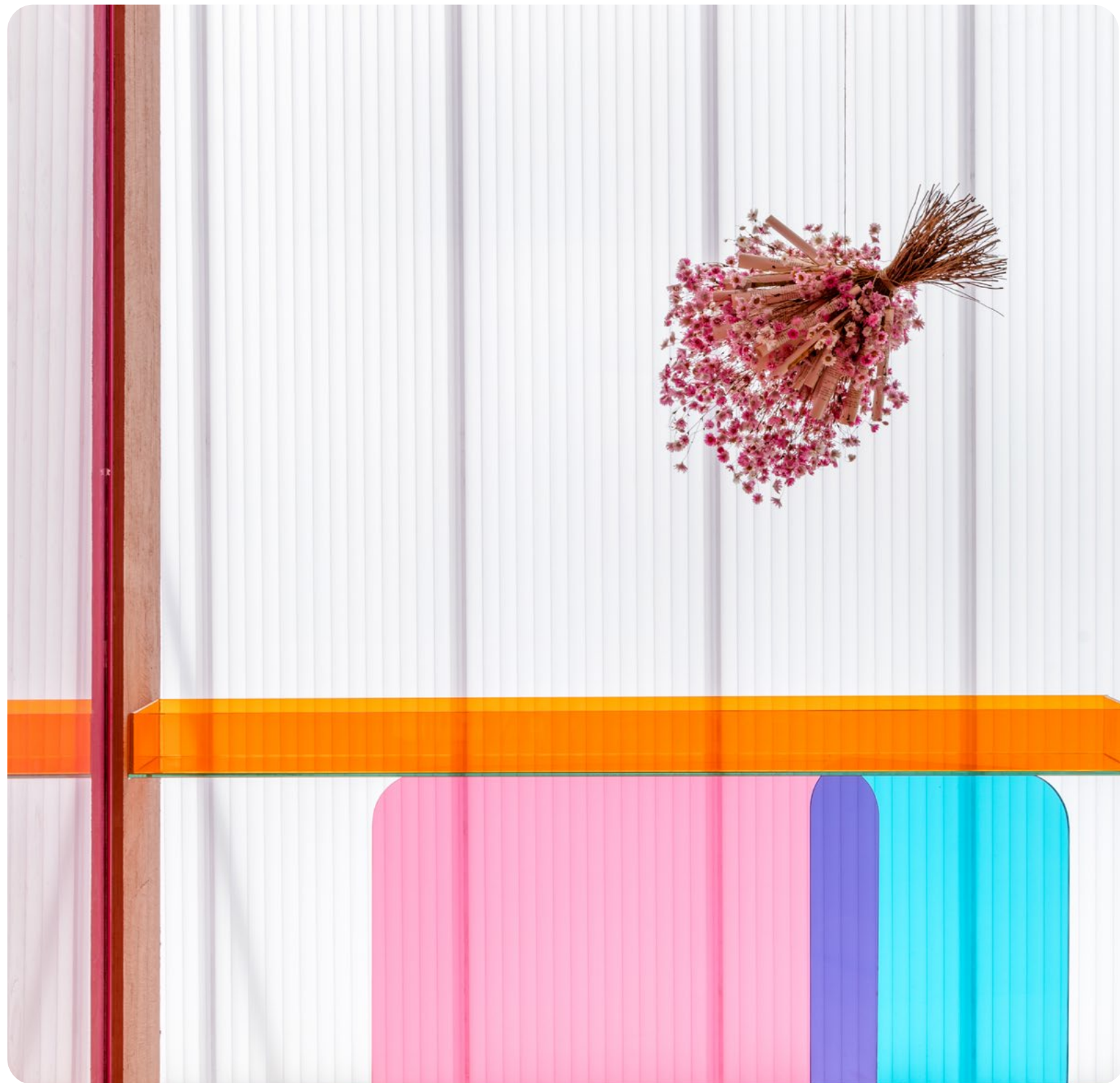

Casa Cor Florianópolis - Vou de Rosa
Juliana Loffi Arquitetura
ARKOWALL BRANCO LEITOSO
São Paulo, SP



Casa Cor Curitiba
Bar Matiz - André Henning Arquitetura
ARKOWALL CRISTAL
Curitiba, PR

ARKOWALL

INSTALAÇÃO

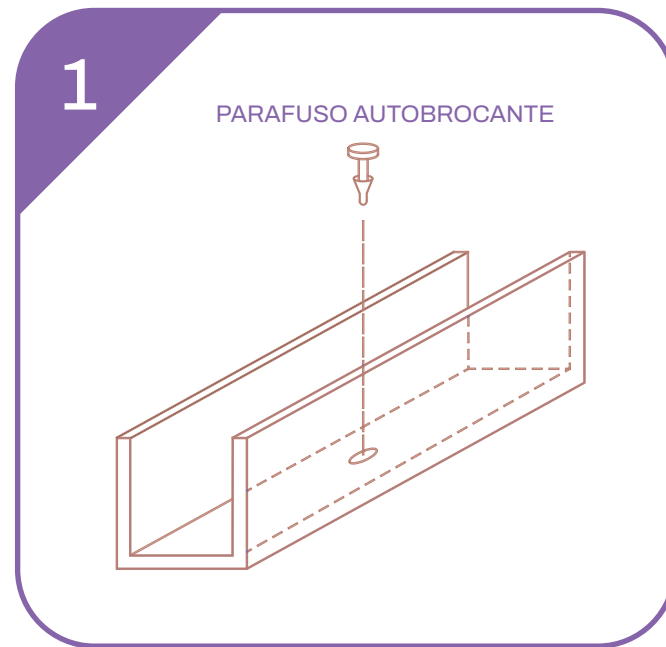

FIXAÇÃO DOS PERFIS “U” NO SOLO,
ALVENARIA E/OU ESTRUTURA METÁLICA

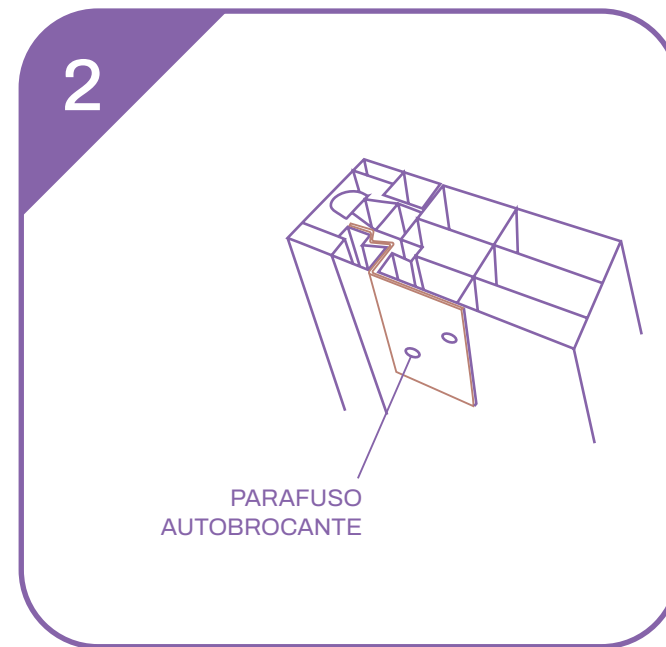

FIXAÇÃO DAS PRESILHAS DA ESTRUTURA
INTERMEDIÁRIA (SE NECESSÁRIO)

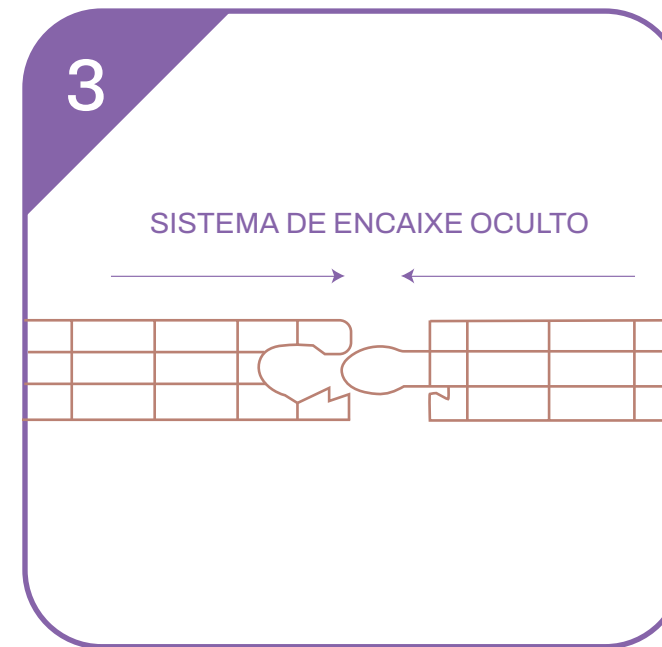

COLOCAÇÃO DOS PAINÉIS, FAZENDO-OS
CORRER DENTRO DO PERFIL “U”

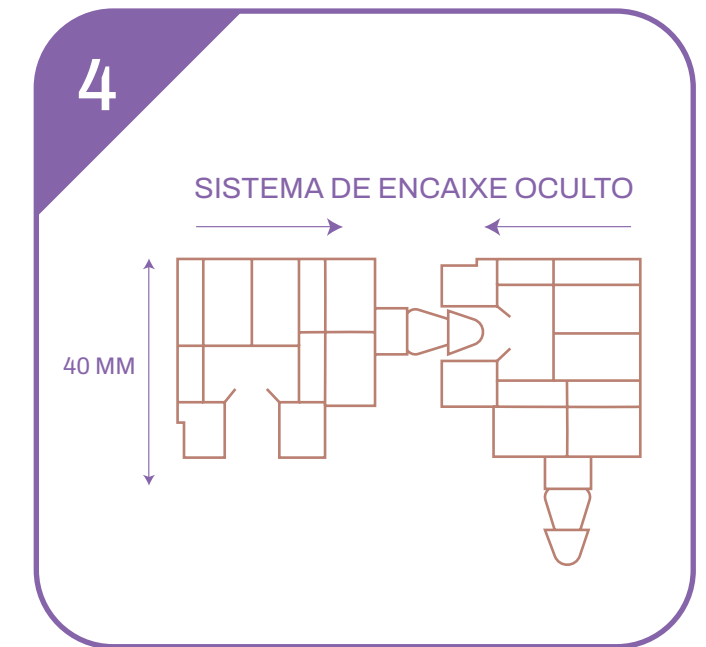

COLOCAÇÃO DAS CANTONEIRAS,
SE NECESSÁRIO

Não inclui elementos acessórios e mão-de-obra.



FIXAÇÃO DO PERFIL "U", ENCAIXANDO OS PAINÉIS

Sistema de fixação

PRESILHA DE FIXAÇÃO

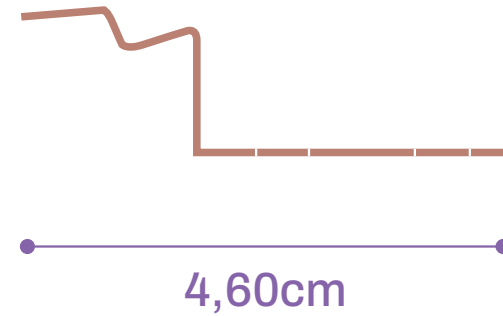

planta

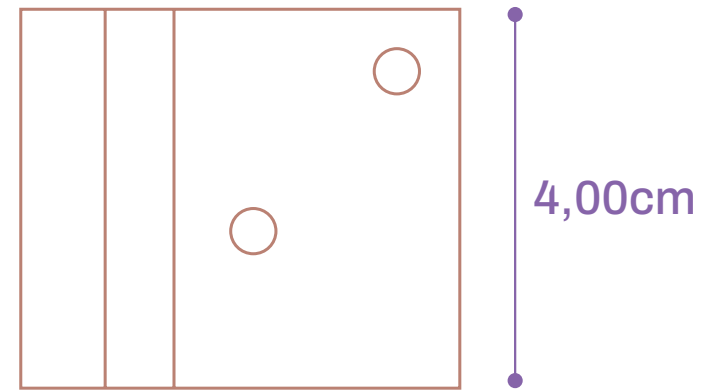

elevação

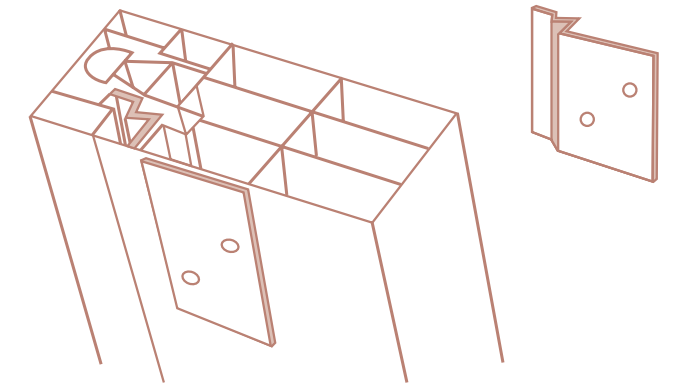

isométrica

CANTONEIRA

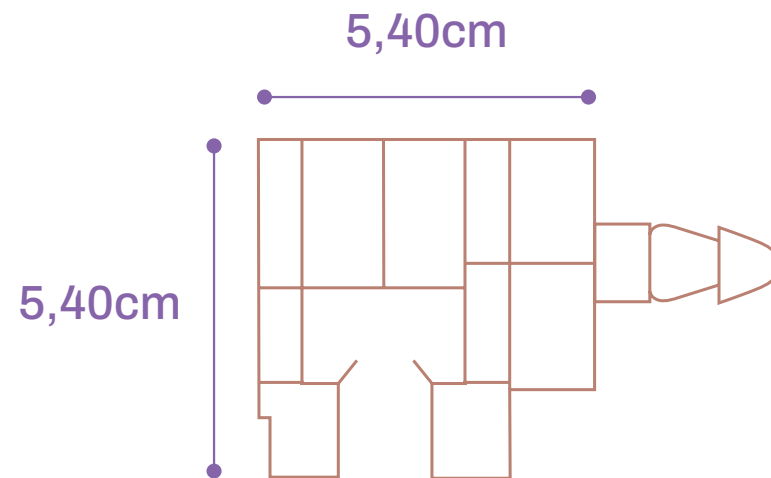

planta

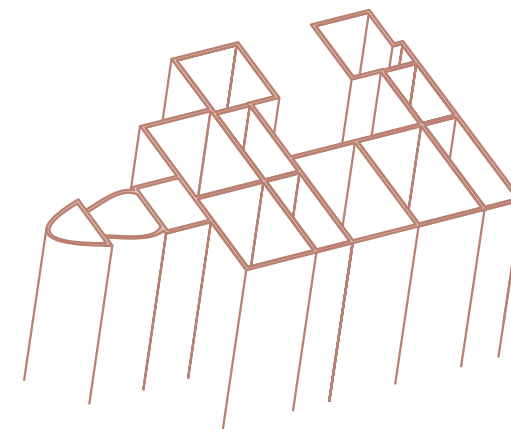

PRESILHAS INCLUÍDAS PARA INSTALAÇÃO EFICIENTE EM FACHADAS - MÃO DE OBRA NÃO INCLUSA

Instalação

01 Fixação dos perfis U em piso e laje

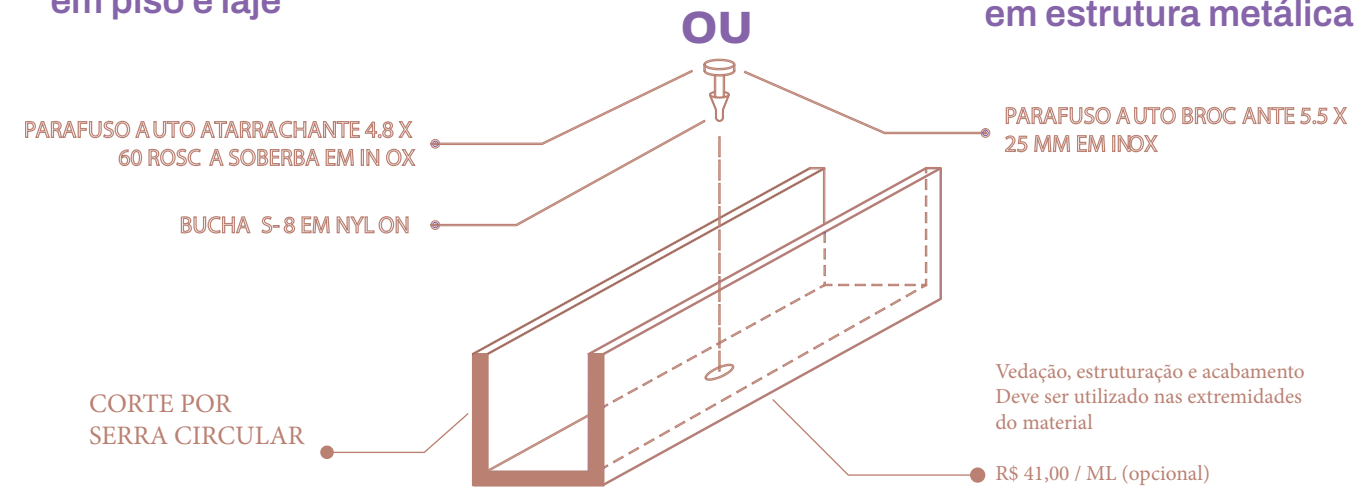

02 Fixação das presilhas na estrutura intermediária (se necessário)

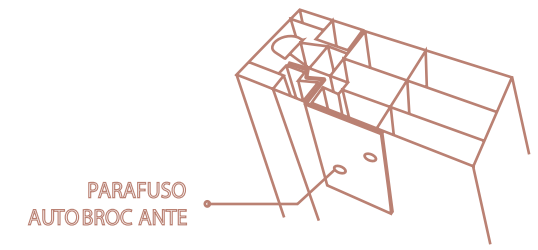
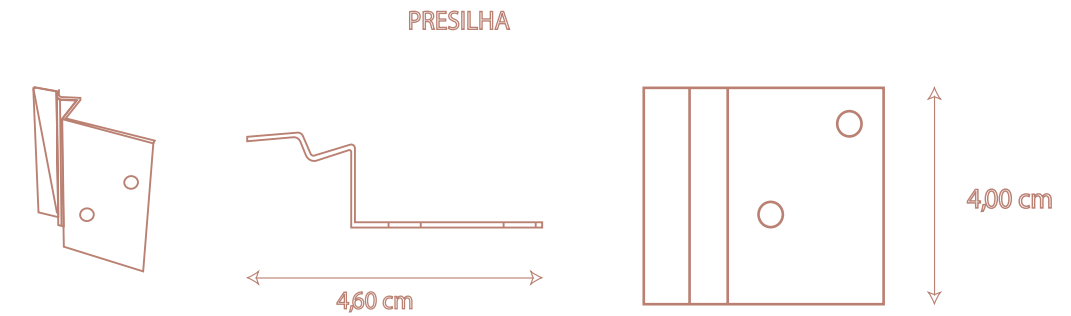

03 Colocação dos painéis, fazendo-os correr entre os perfis U

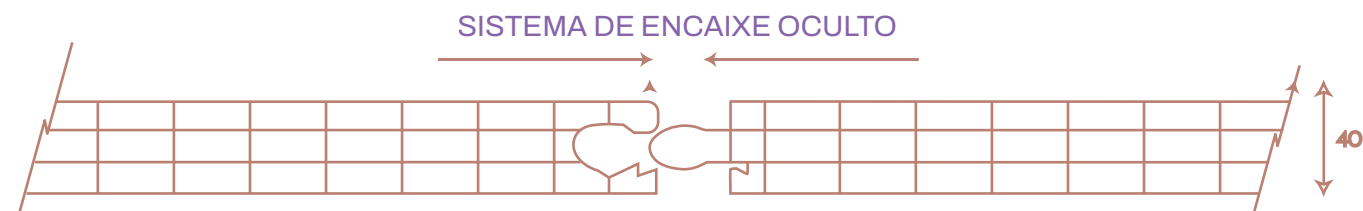

04 Colocação das cantoneiras, se necessário

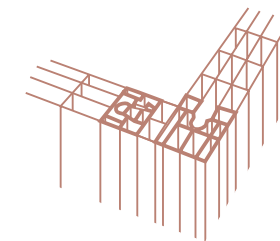
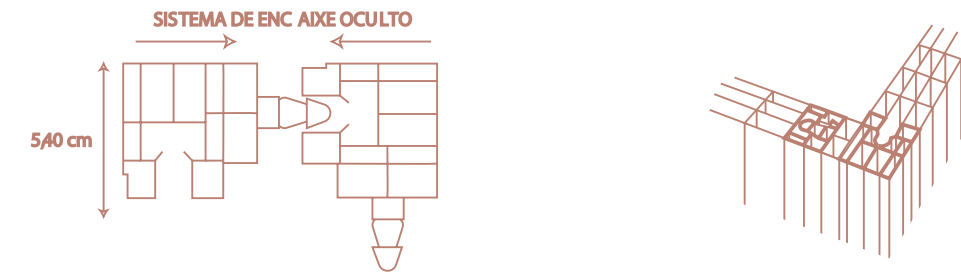

arkowall

REFORÇO - CONTRAVENTAMENTO

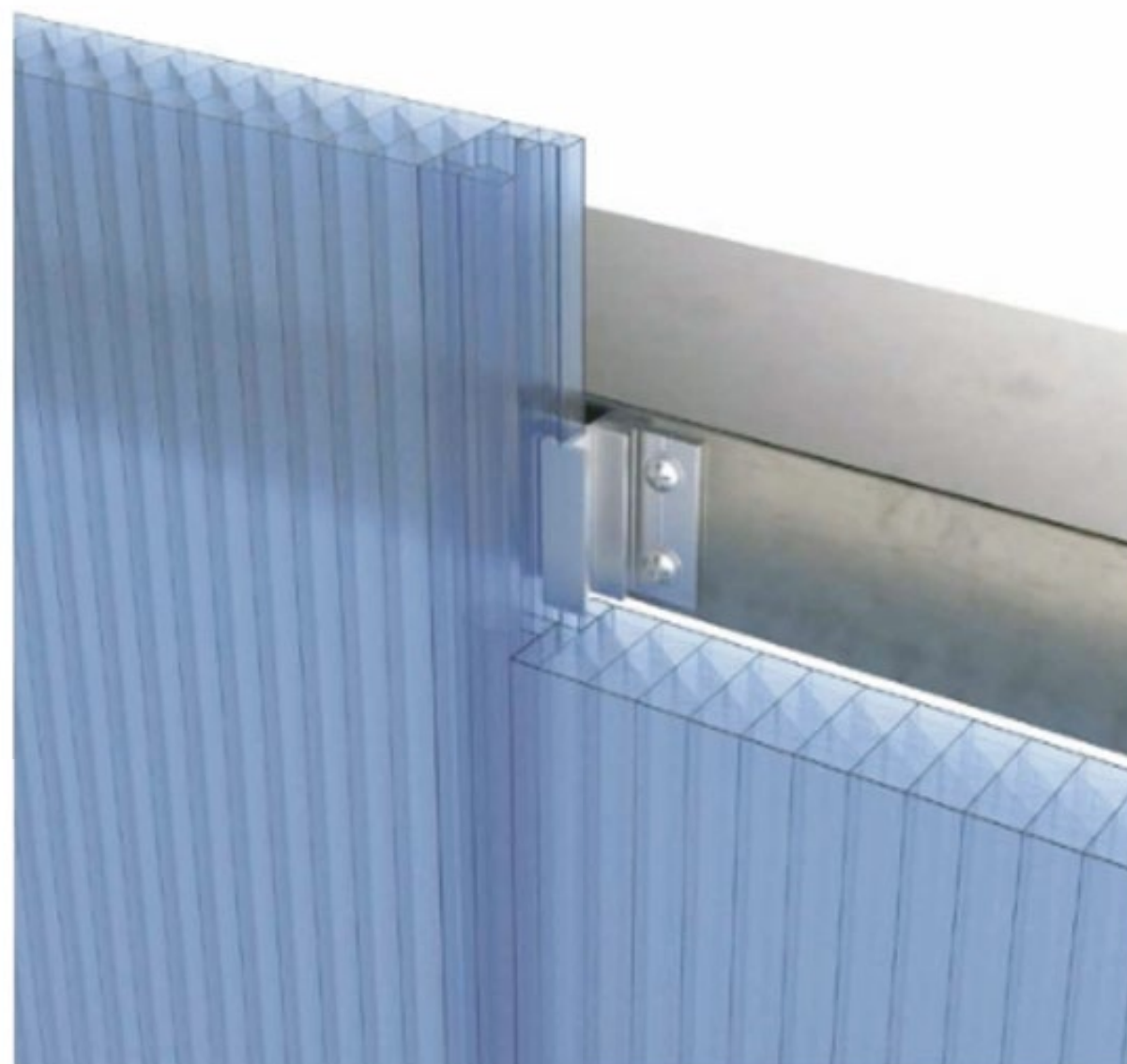
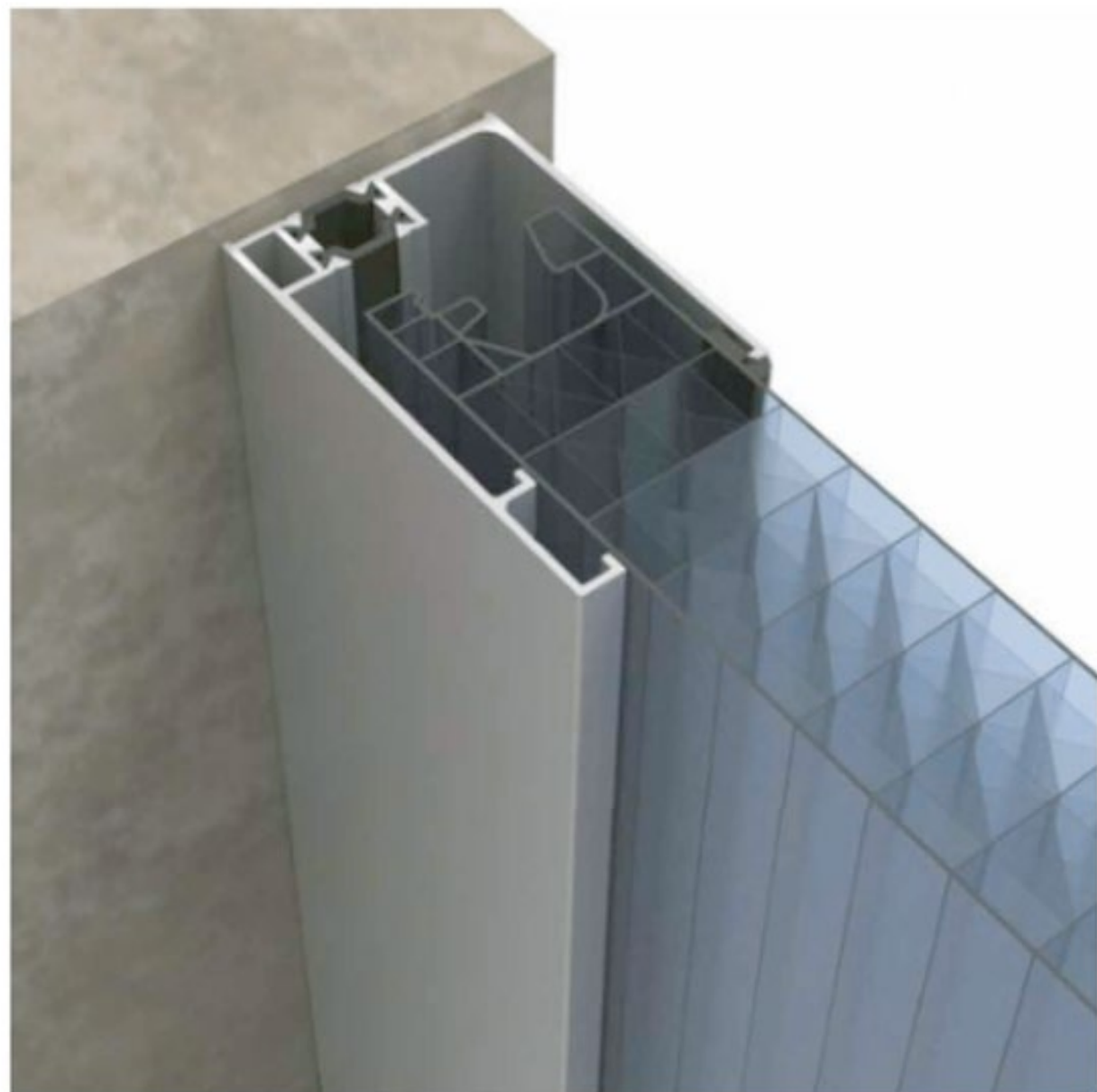

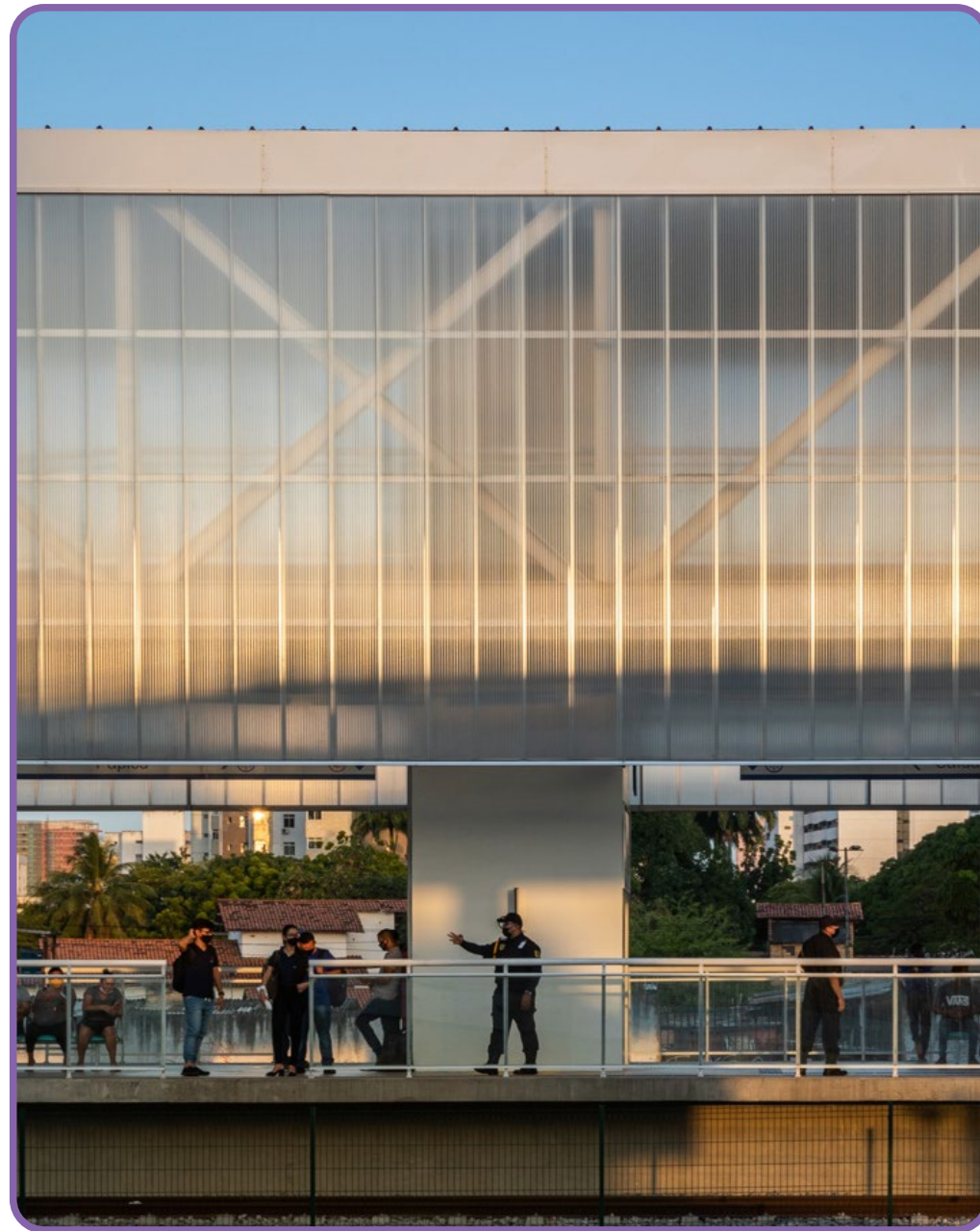
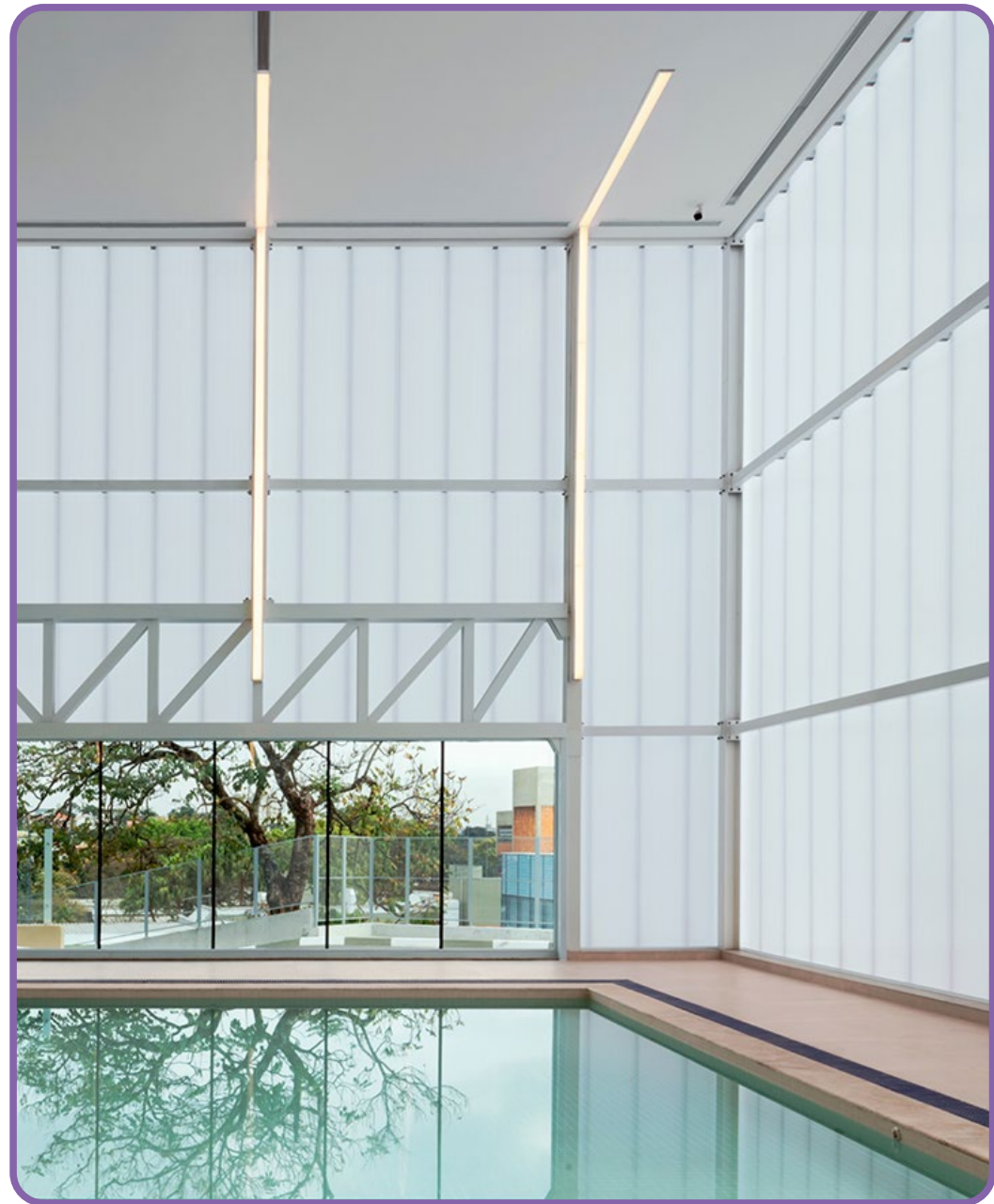

arkowall

REFORÇO ESTRUTURAL

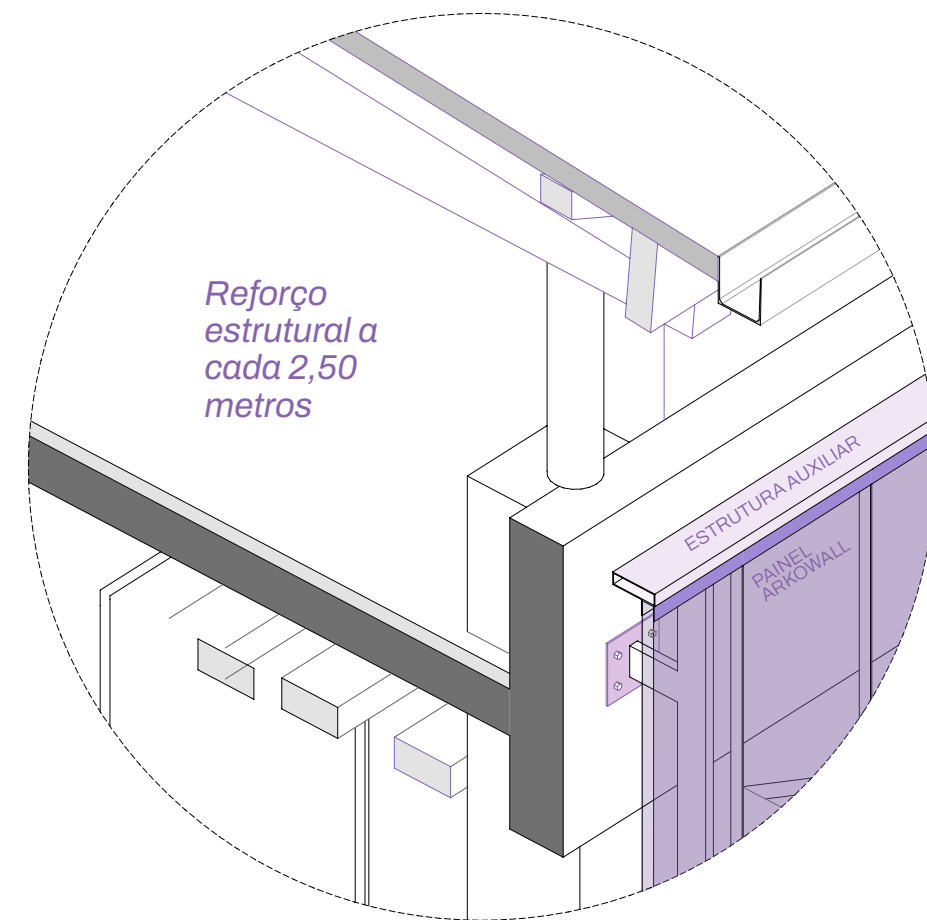



arkowall

APLICAÇÕES DIFERENCIADAS

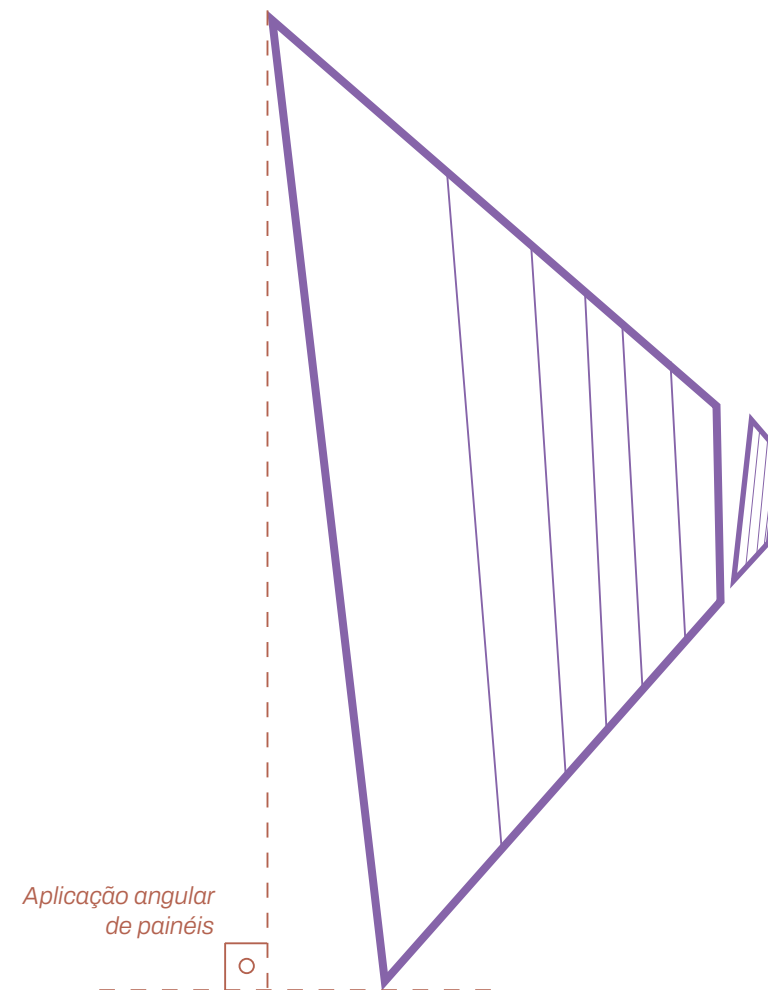

*Aplicação angular
de painéis*



arkowall

COMBINAÇÃO DE CORES

Projeto com painéis coloridos em todas as

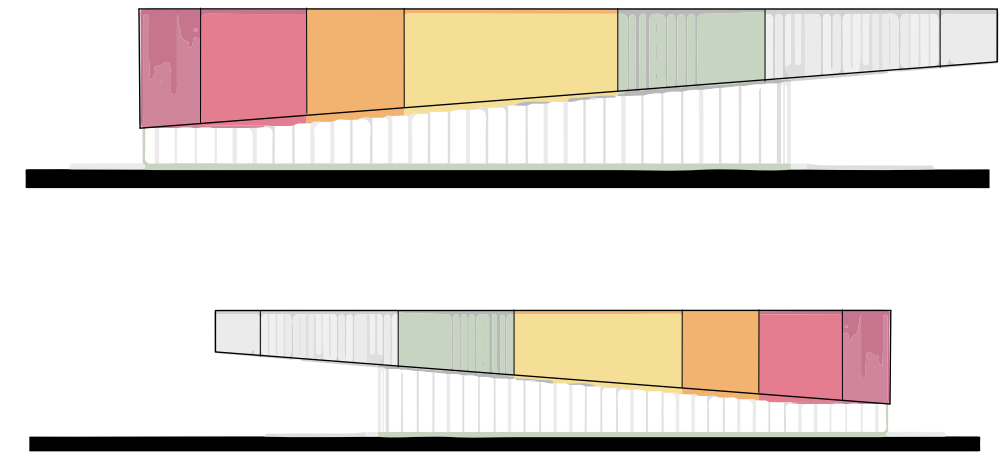

ARKOWALL

FERRAMENTAS DE INSTALAÇÃO



CORTADOR DE DISCO CIRCULAR



DISCO CIRCULAR PARA MADEIRA



PARAFUSADEIRA COM PARAFUSO
PERFURANTE DE CABEÇA CHATA

Peso ML = 2kg por ML

Peso M² = 4,00kg

- As chapas devem ser armazenadas na horizontal (deitadas) sobre uma superfície plana. Certifique -se que as placas fiquem em um local seco e ventilado, protegidas de luz solar direta, chuva e vento.
- O filme de proteção (liner) deve ser retirado imediatamente após a instalação do material.
- Evitar solventes e outros produtos corrosivos. O álcool reage com o policarbonato e causa manchas.
- Para limpezas simples, utiliza-se detergente neutro, esponja macia ou pano 100% algodão e água. Para limpezas de sujeiras mais pesadas, pode-se utilizar uma jato de água com baixa pressão.
- Recomenda-se limpeza periódica a cada 6 meses, a fim de manter as características do produto por mais tempo possível;
- Chapas de policarbonato alveolar, com até 11,80m de comprimento; - Tratamento com proteção UV na face externa;
- 4 paredes (3 câmaras);
- Material leve e resistente a impacto;
- Resistência a altas e baixas temperaturas (min. -40o | máx. 130oC);
- Rápida instalação e economia na estrutura.

Chapas de policarbonato alveolar, com até 11,80m de comprimento;
Material leve e resistente a impacto;
Resistência a altas e baixas temperaturas (min. -40°/máx. 130°C);
Rápida instalação e economia na estrutura.

ARKOWALL 40X500MM
Peso por ML: 2,00 kg/ML
Peso por M²: 4,00 kg/M²

Proteção Anti-UV na face externa
Isolamento acústico - Rw 25dB conforme DIN ISO EN 140-3
Flamabilidade - Fogo Classe B2 conforme DIN 4102

DADOS TÉCNICOS	VALOR	UNIDADE
Largura	500 +- 1%	mm
Espessura	40 +- 1%	mm
Número de paredes	4 paredes (3 câmaras)	-
Módulo de elasticidade	240	N/mm ²
Coefficiente de dilatação linear	0,065	mm/m°C
Proteção Anti-UV	Face externa	-

AMANTES DE BOA ARQUITETURA

arkos

www.arkosbrasil.com.br

 arkosbrasil



 +5511971196692