

arkos

# ARKOTECH

---

PAINÉIS LAMINADOS DE ALTA DENSIDADE PARA FACHADAS  
VENTILADAS



## Características

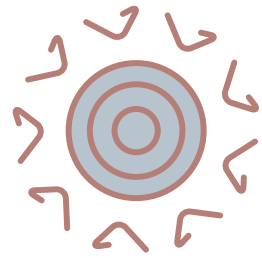

Proteção UV

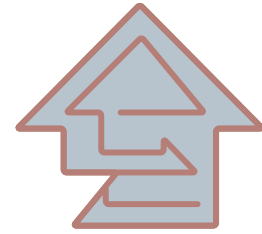

Alta durabilidade

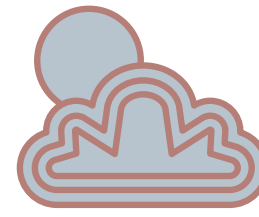

Aplicável em todos os tipos de clima

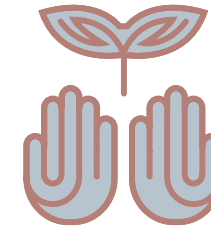

Responsabilidade ambiental

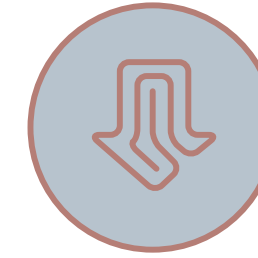

Fácil instalação

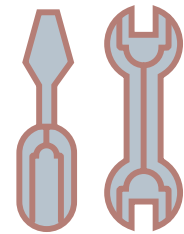

Não requer manutenção

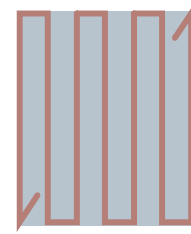

Fachada sustentável

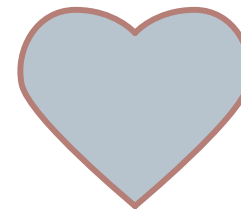

Vida útil de mais de 20 anos

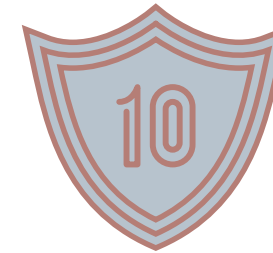

Garantia de 10 anos



# ARKOTECH

## COMPOSIÇÃO

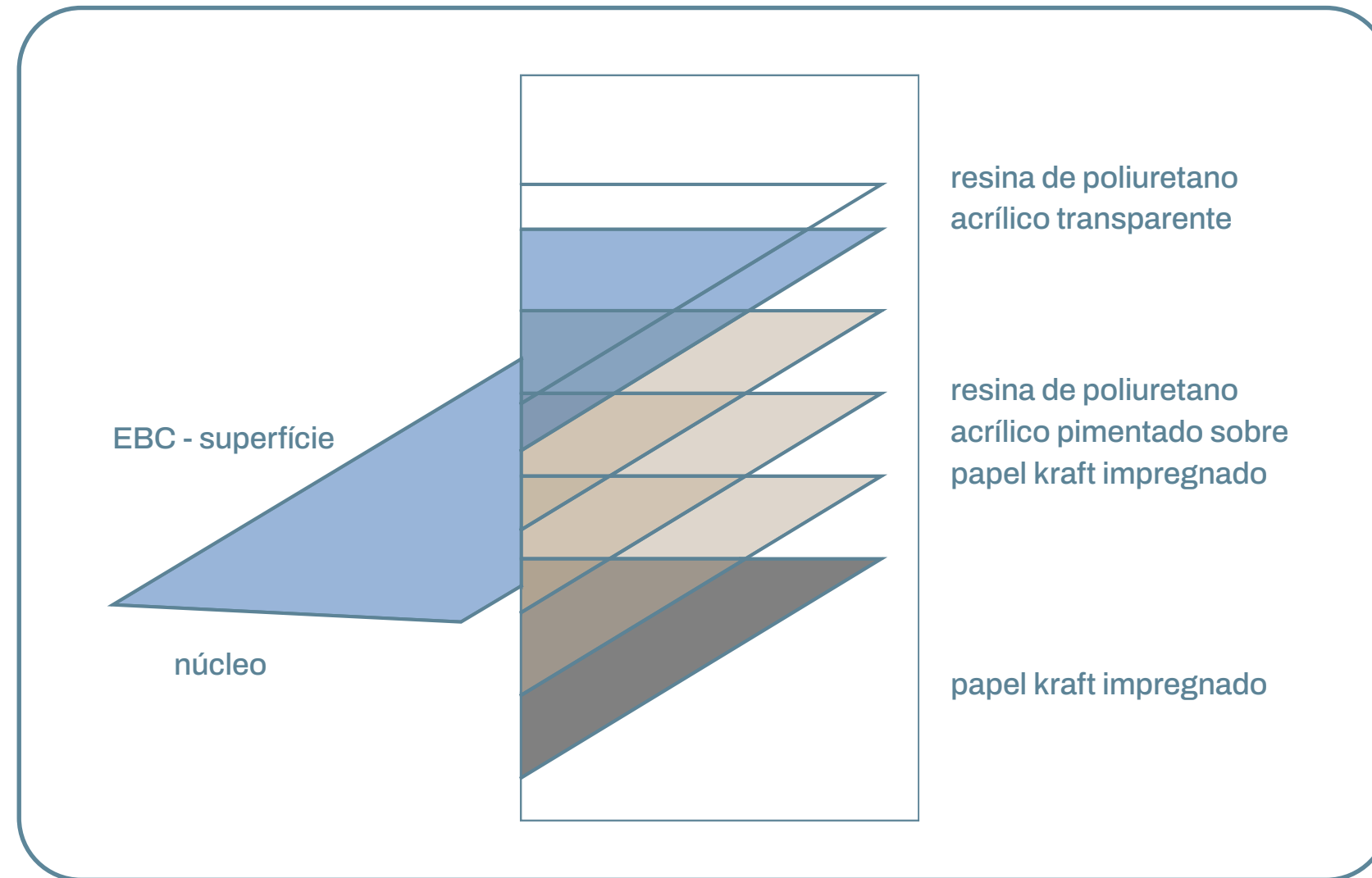

ARKOTECH

TAMANHOS DISPONÍVEIS

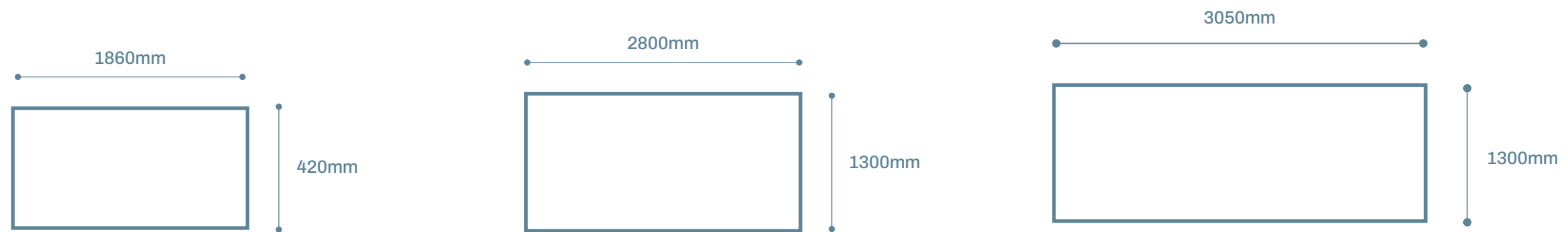

1860x4200mm sob encomenda, opções limitadas de cores

# ARKOTECH

## SEÇÕES E PREÇOS

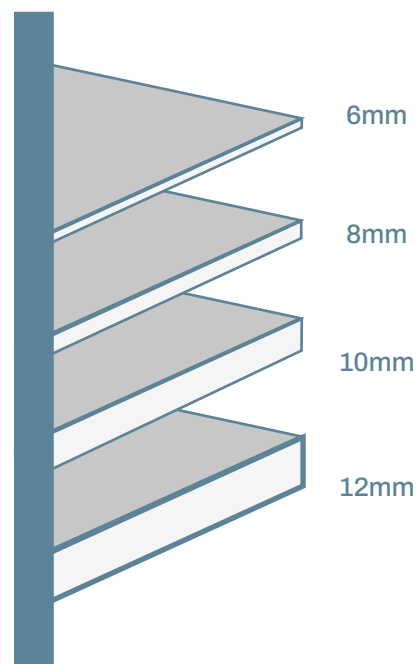

FACE ÚNICA  
COLOR

FACE DUPLA  
COLOR

FACE ÚNICA  
WOOD&STONE

FACE DUPLA  
WOOD&STONE

R\$854

R\$939

R\$864

R\$950

R\$1025

R\$1226

R\$1037

R\$1040

R\$1100

R\$1220

R\$1123

R\$1035

R\$1195

R\$1314

R\$1209

R\$1330

# ARKOTECH

## CORES DISPONÍVEIS PLAIN COLORS



3153



3159



3239



3163



3276



3251



3286

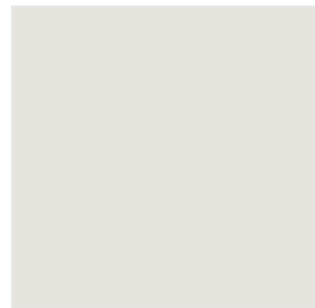

3240



3260

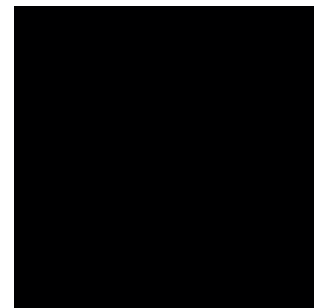

3190



3104



3148



3252



3281



3156



3155



3168

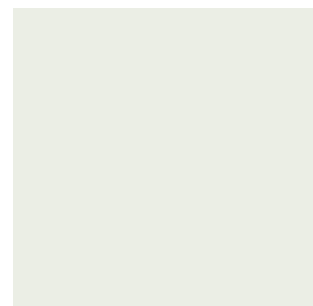

3296



3167



3253



3262

Tamanhos disponíveis: 1.300mm x 2.800mm / 1.300mm x 3050mm / 1.400mm x 4200mm  
\*Alguns modelos também estão disponíveis em 1.860mm x 4.200mm - consulte nossos colaboradores

# ARKOTECH

## CORES DISPONÍVEIS PLAIN COLORS



3285



3284



3297



3299



3291



3126



3158



3282



3246



3292

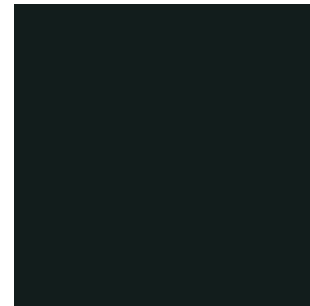

3238



3140



3274



3245



3137



3131



3300



3289



3127



3164



3242

Tamanhos disponíveis: 1.300mm x 2.800mm / 1.300mm x 3050mm / 1.400mm x 4200mm  
\*Alguns modelos também estão disponíveis em 1.860mm x 4.200mm - consulte nossos colaboradores

# ARKOTECH

## CORES DISPONÍVEIS PLAIN COLORS



3116

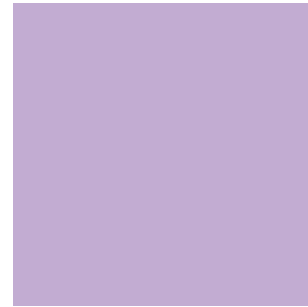

3119



3134



3145

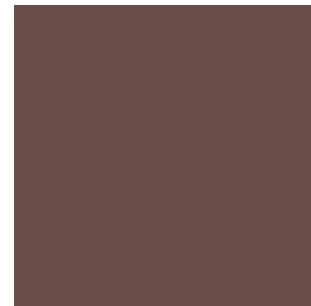

3278



3288



3275



3279



3294



3272



3169

Tamanhos disponíveis: 1.300mm x 2.800mm / 1.300mm x 3050mm / 1.400mm x 4200mm  
\*Alguns modelos também estão disponíveis em 1.860mm x 4.200mm - consulte nossos colaboradores

# ARKOTECH

## CORES DISPONÍVEIS

### WOOD



4584

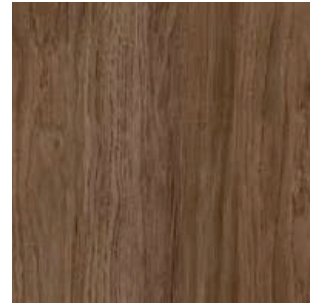

4657



4628

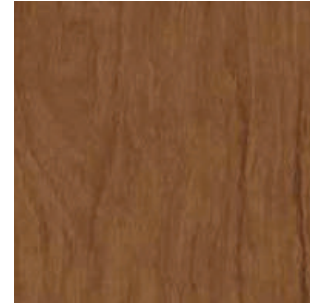

4389



4479



4583



4509

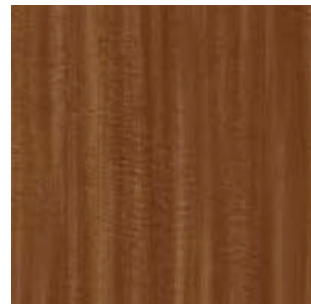

4530



4626

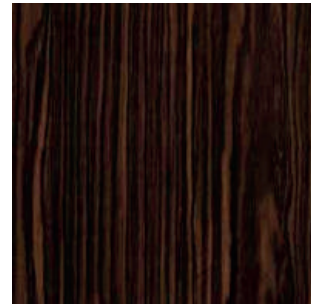

4290

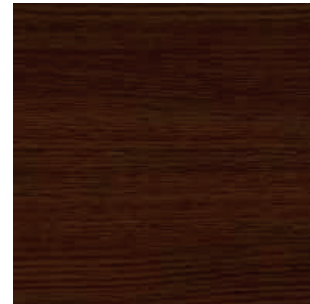

4378

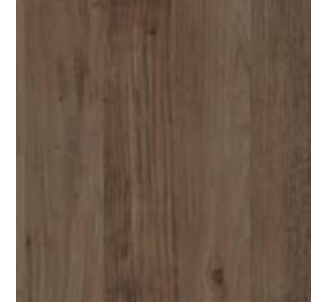

4632



4428

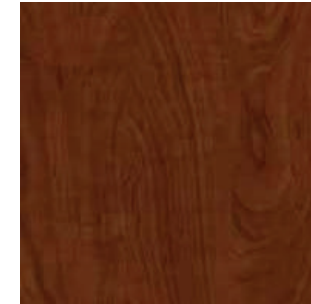

4258

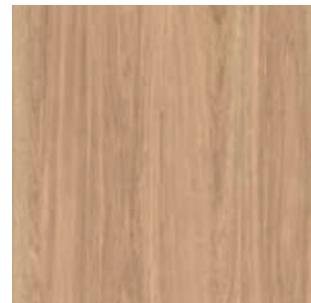

4662



4347



4523

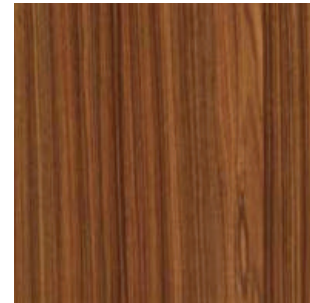

4292

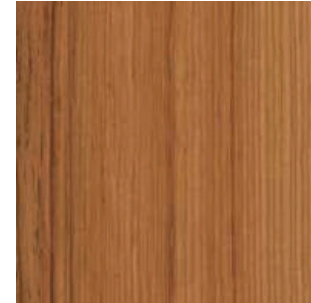

4395



4348

Tamanhos disponíveis: 1.300mm x 2.800mm / 1.300mm x 3050mm / 1.400mm x 4200mm  
\*Alguns modelos também estão disponíveis em 1.860mm x 4.200mm - consulte nossos colaboradores

# ARKOTECH

## CORES DISPONÍVEIS

### WOOD



4550

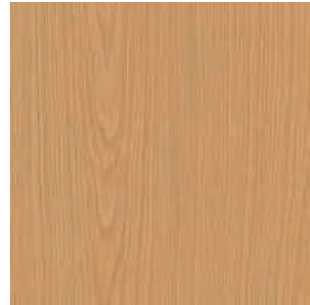

4220

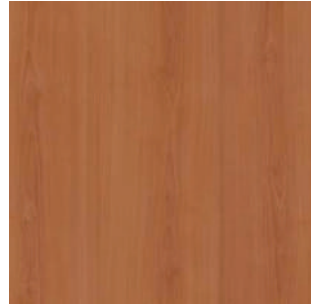

4251



5638



4241



4399



4525

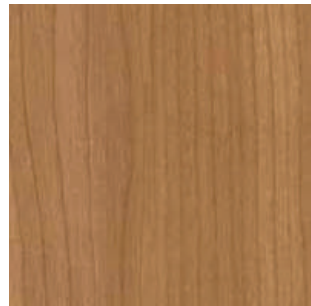

4270

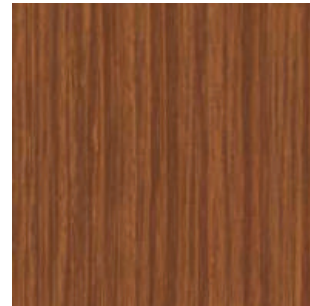

4394



4552

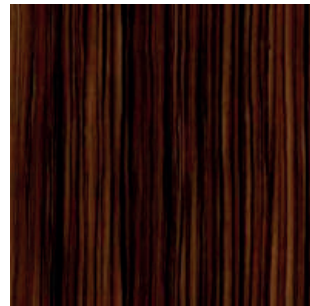

4485

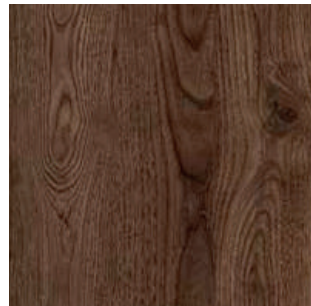

4627

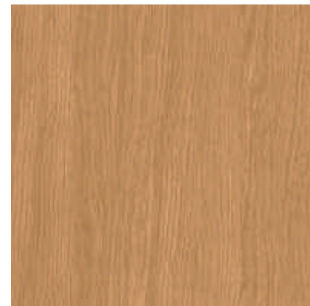

4598



4510



4551

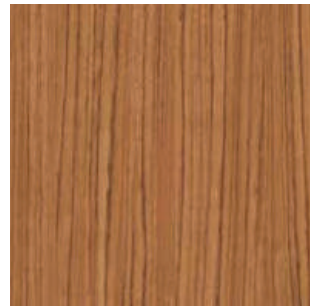

4234



4252



4570



4666

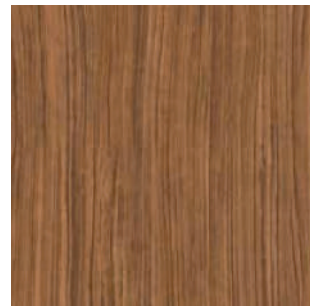

4273

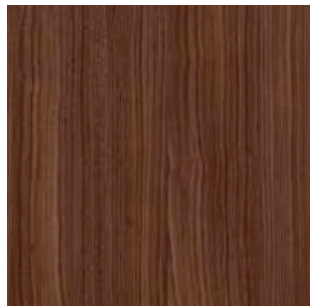

4484

Tamanhos disponíveis: 1.300mm x 2.800mm / 1.300mm x 3050mm / 1.400mm x 4200mm  
\*Alguns modelos também estão disponíveis em 1.860mm x 4.200mm - consulte nossos colaboradores

# ARKOTECH

## CORES DISPONÍVEIS

### WOOD

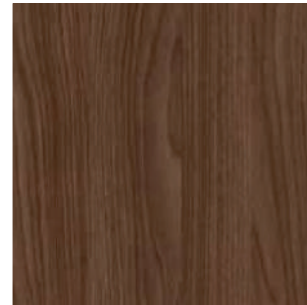

4271

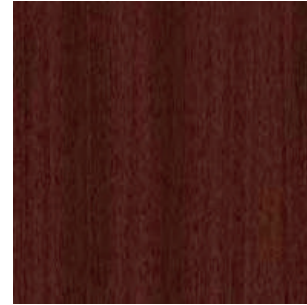

4248



4655

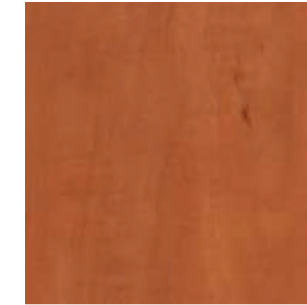

4257

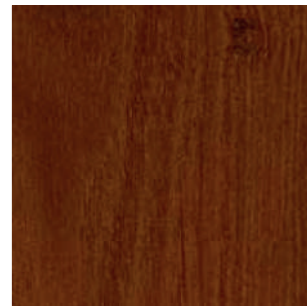

4281

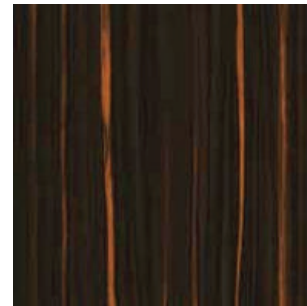

4518



4597



4631

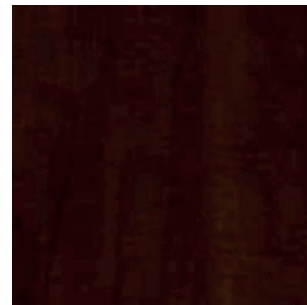

4502

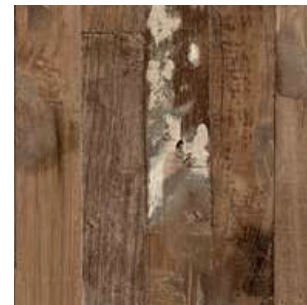

4614



4656

Tamanhos disponíveis: 1.300mm x 2.800mm / 1.300mm x 3050mm / 1.400mm x 4200mm  
\*Alguns modelos também estão disponíveis em 1.860mm x 4.200mm - consulte nossos colaboradores

# ARKOTECH

## CORES DISPONÍVEIS

### NATURAL STONE & CONCRETE



5677



5576

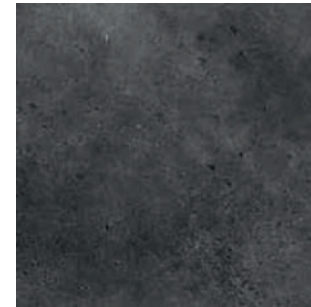

5672



5663

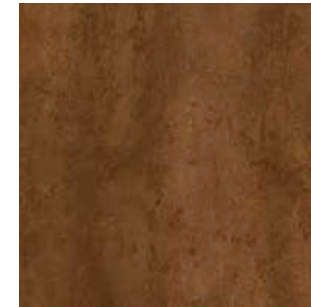

5678

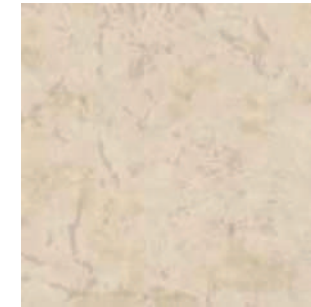

5419



5687



5662

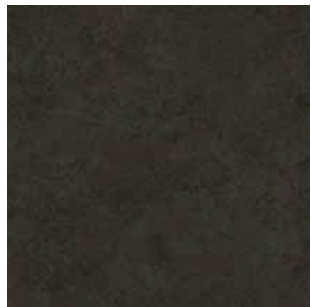

5646



5544



5629



5702

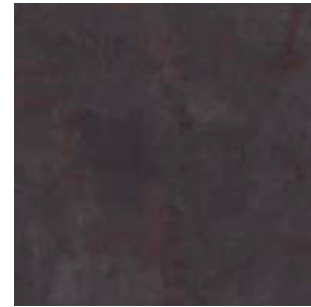

5630



5742



5635

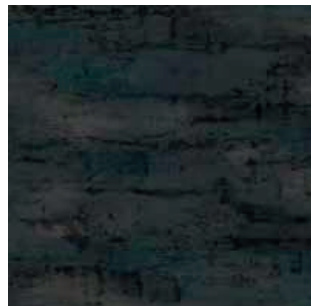

5686

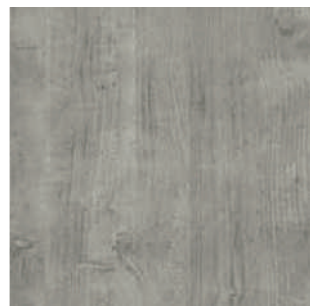

5649

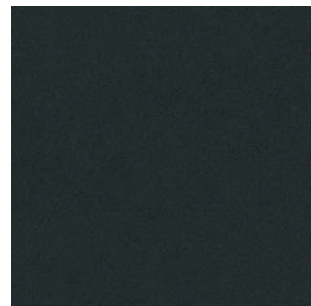

5450



5634



5689



5644

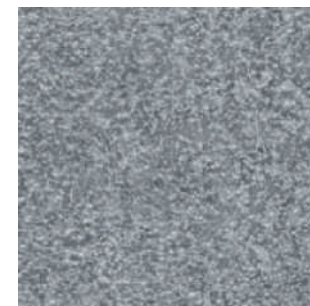

5690

Tamanhos disponíveis: 1.300mm x 2.800mm / 1.300mm x 3050mm / 1.400mm x 4200mm  
\*Alguns modelos também estão disponíveis em 1.860mm x 4.200mm - consulte nossos colaboradores

ARKOTECH

---

PROJETOS INSTITUCIONAIS



**Edifício Une**

Gui Mattos Arquitetura  
São Paulo, SP

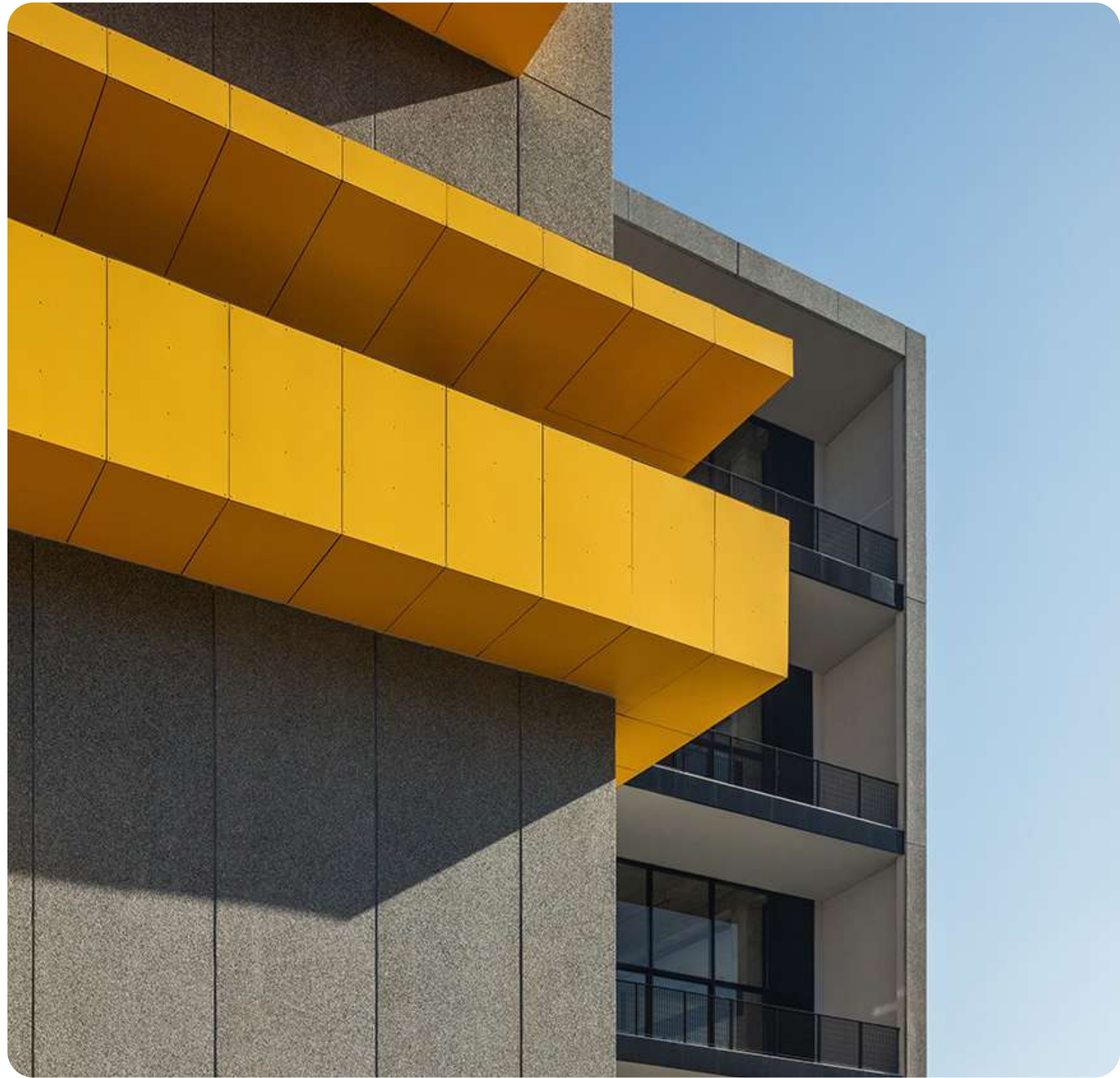

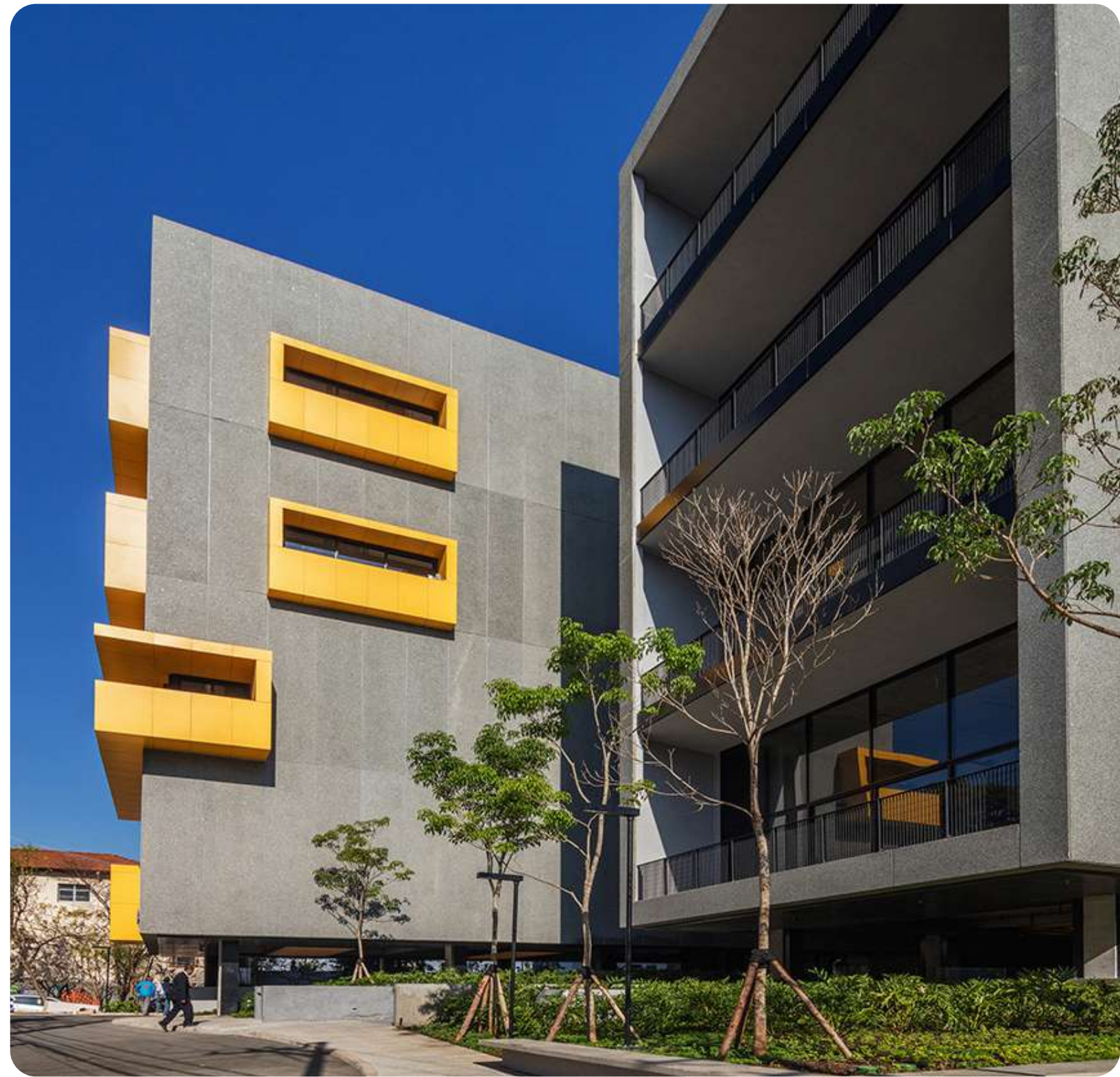
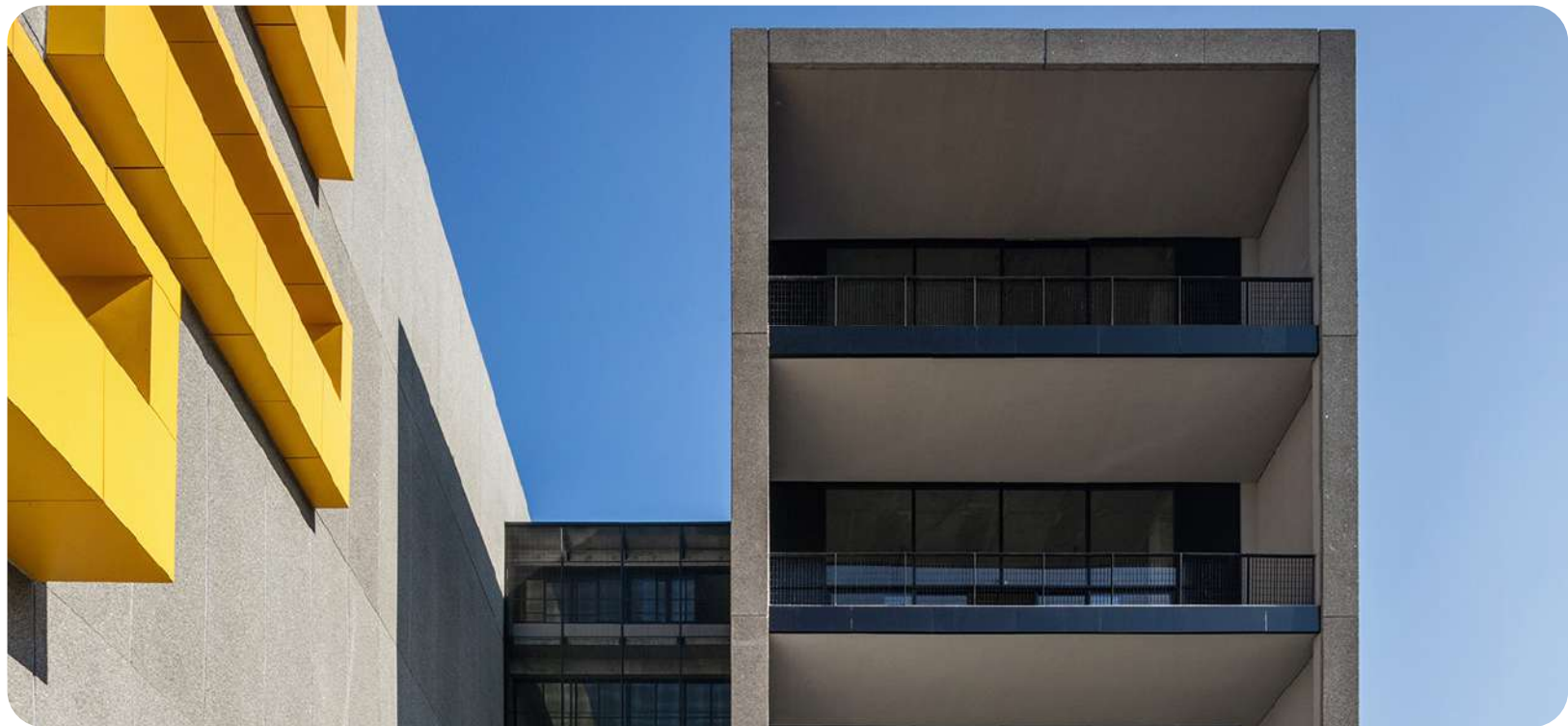









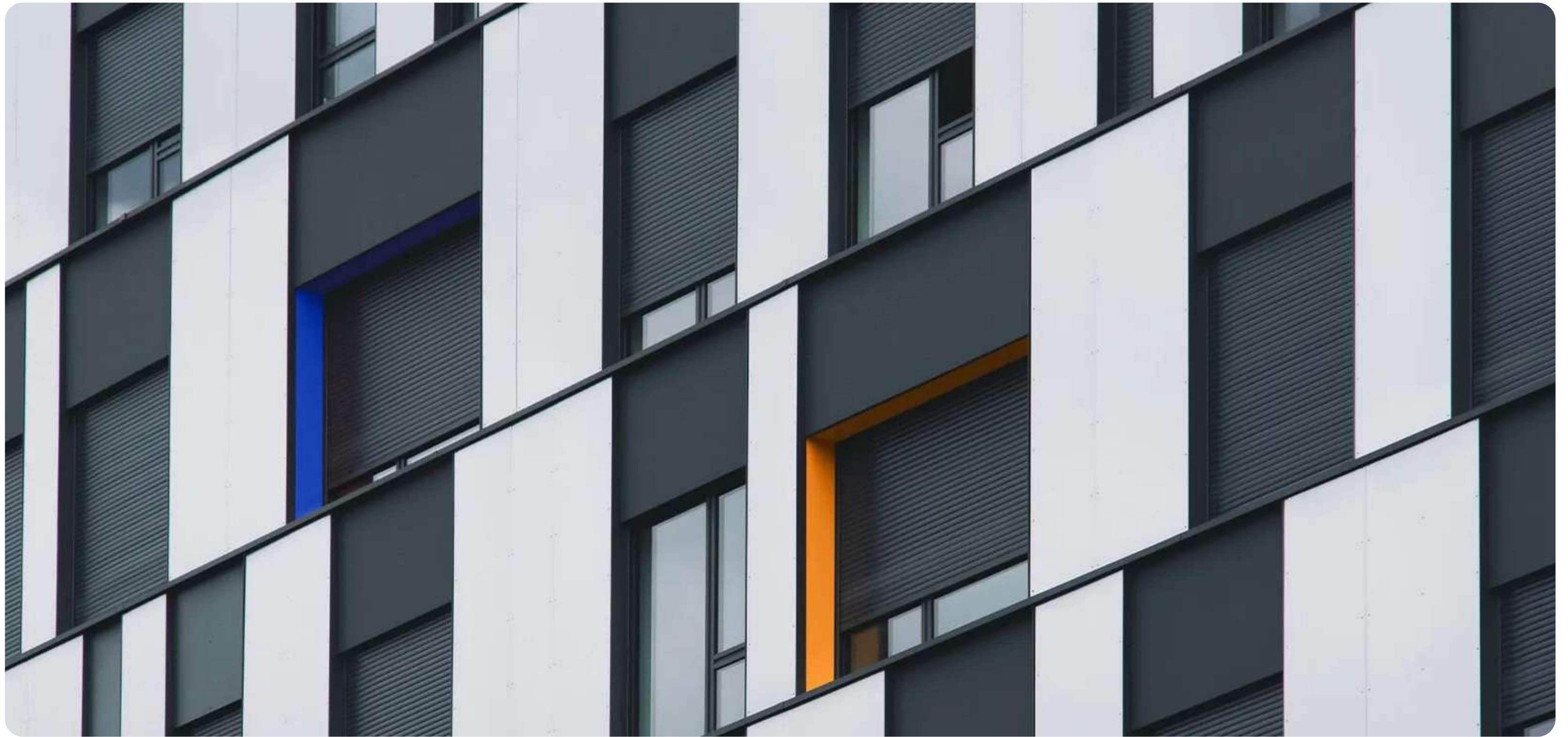

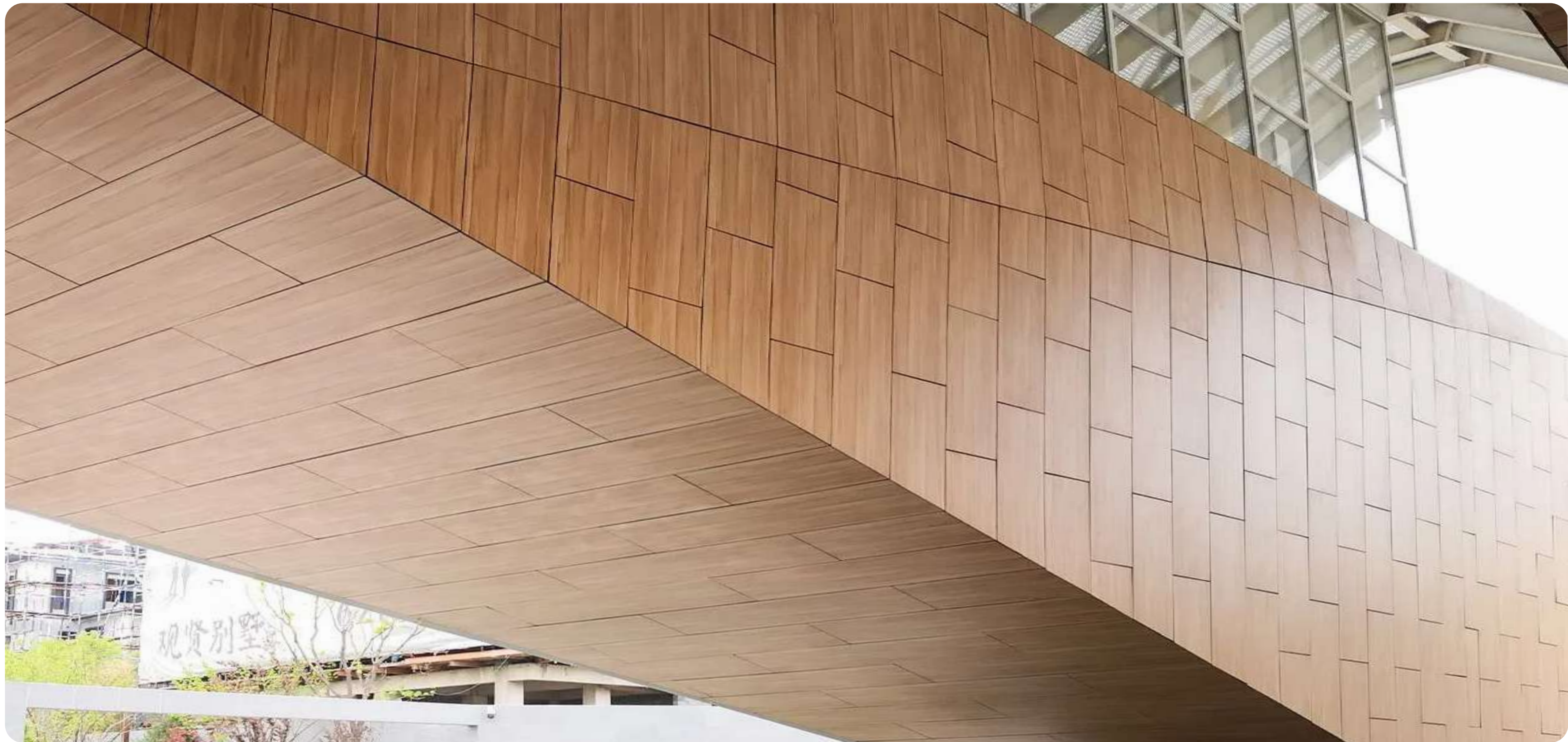







**AltaPlaza Mall**  
Cidade do Panamá









**Hospital Real D'Or Materno Infantil**

RAF Arquitetura  
Rio de Janeiro, RJ



**Hospital Brasil**  
RAF Arquitetura  
São Paulo, SP

**BRASIL**  
Hospital e Maternidade





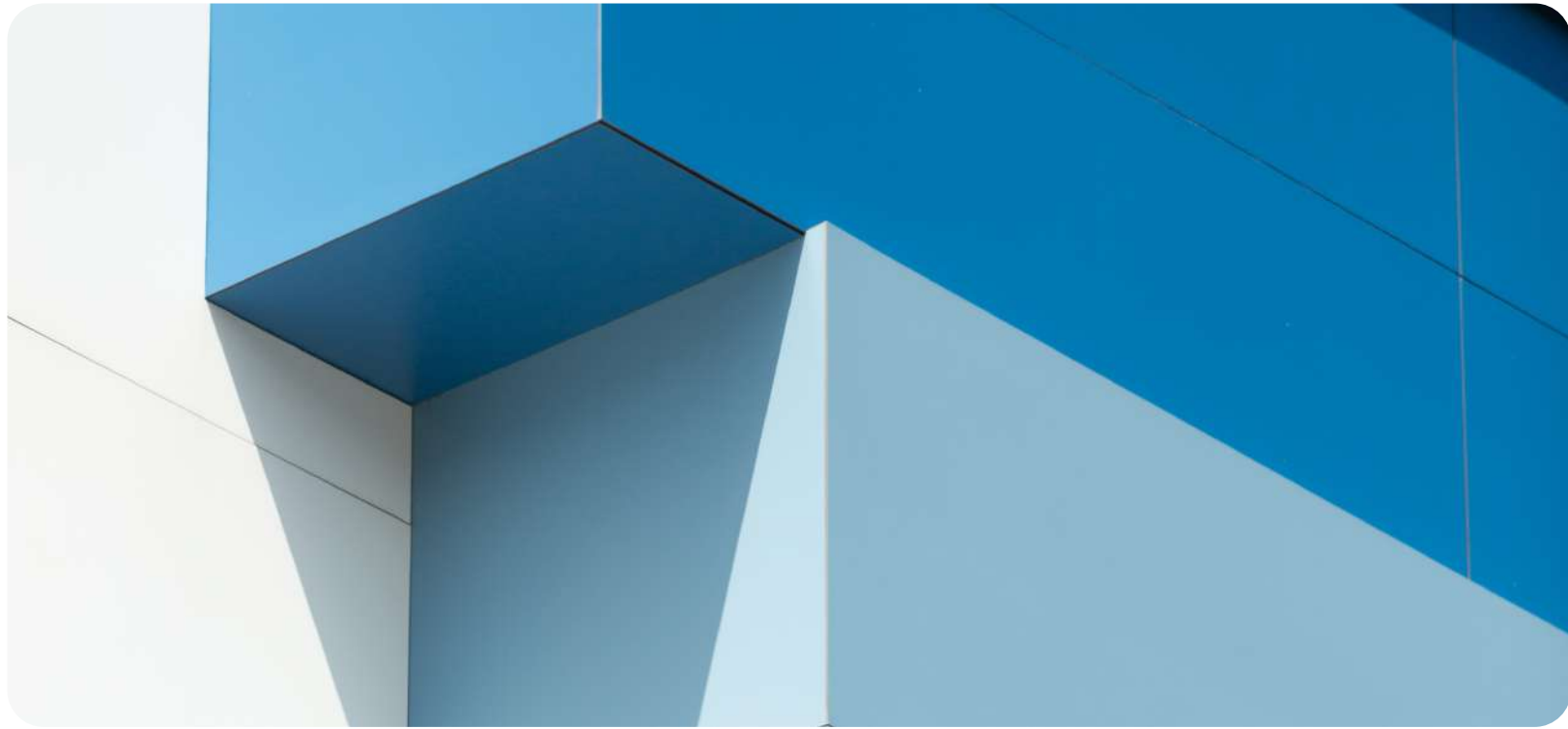

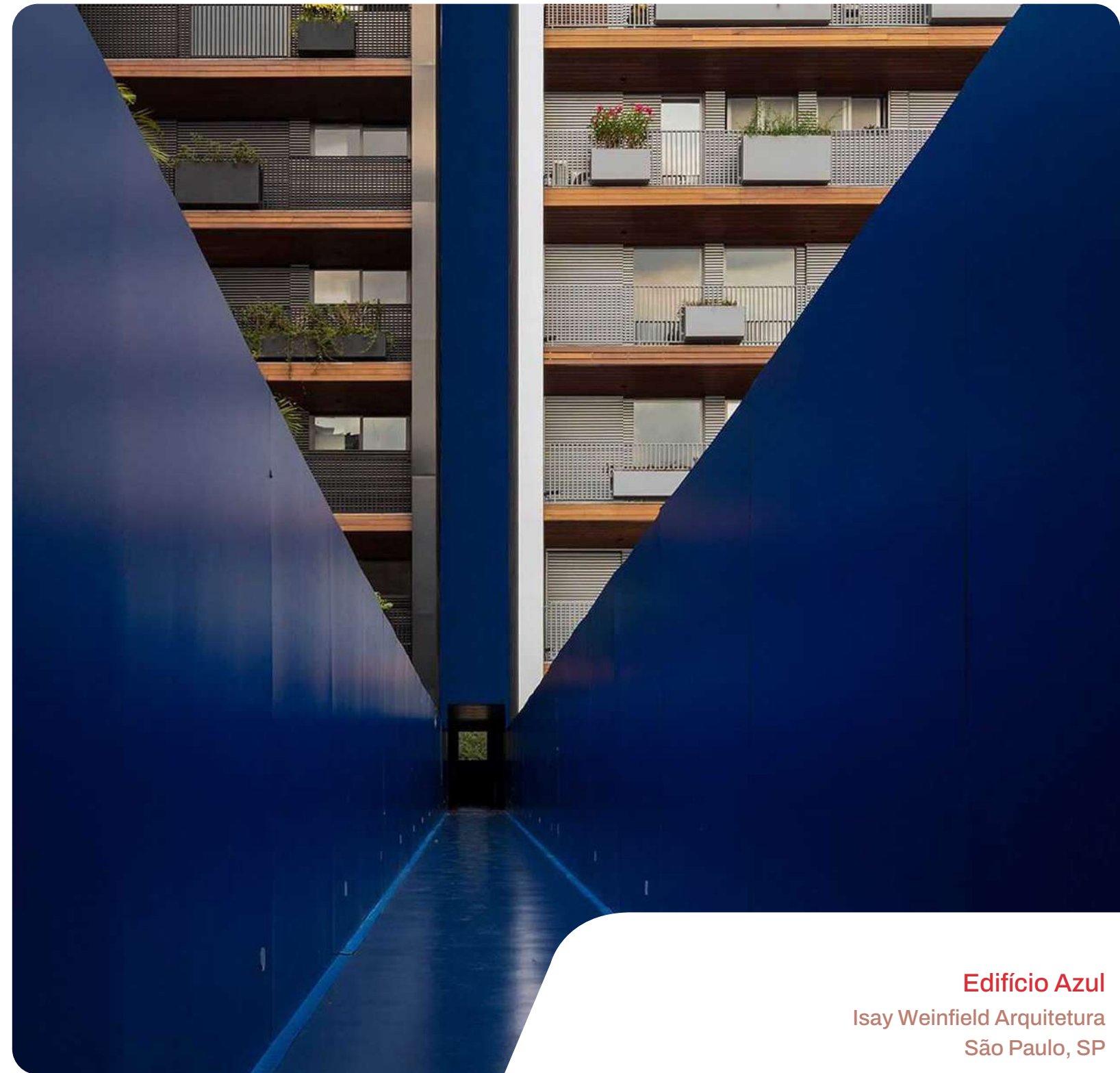

**Edifício Azul**  
Isay Weinfield Arquitetura  
São Paulo, SP

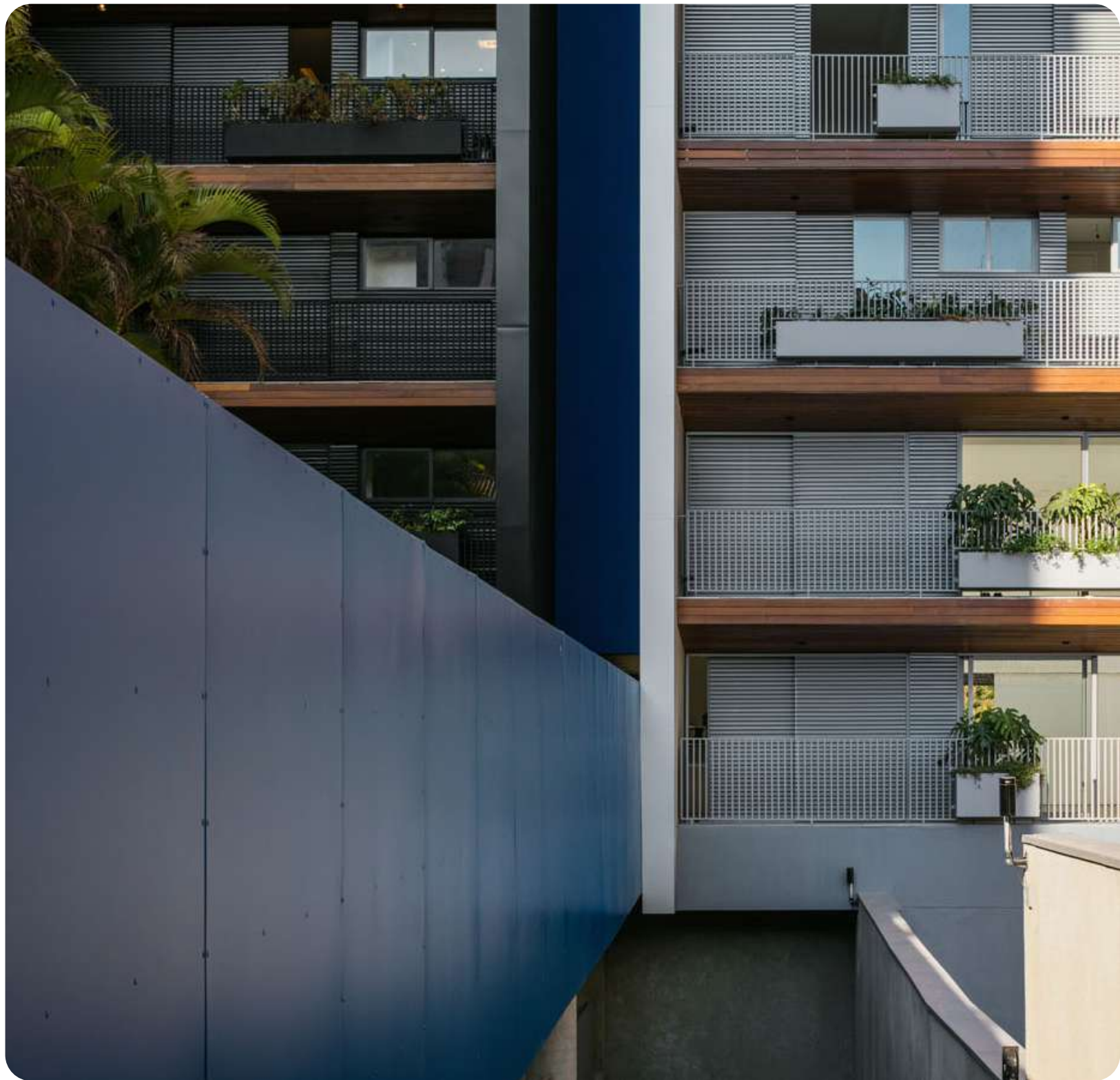

ARKOTECH

---

PROJETOS RESIDENCIAIS

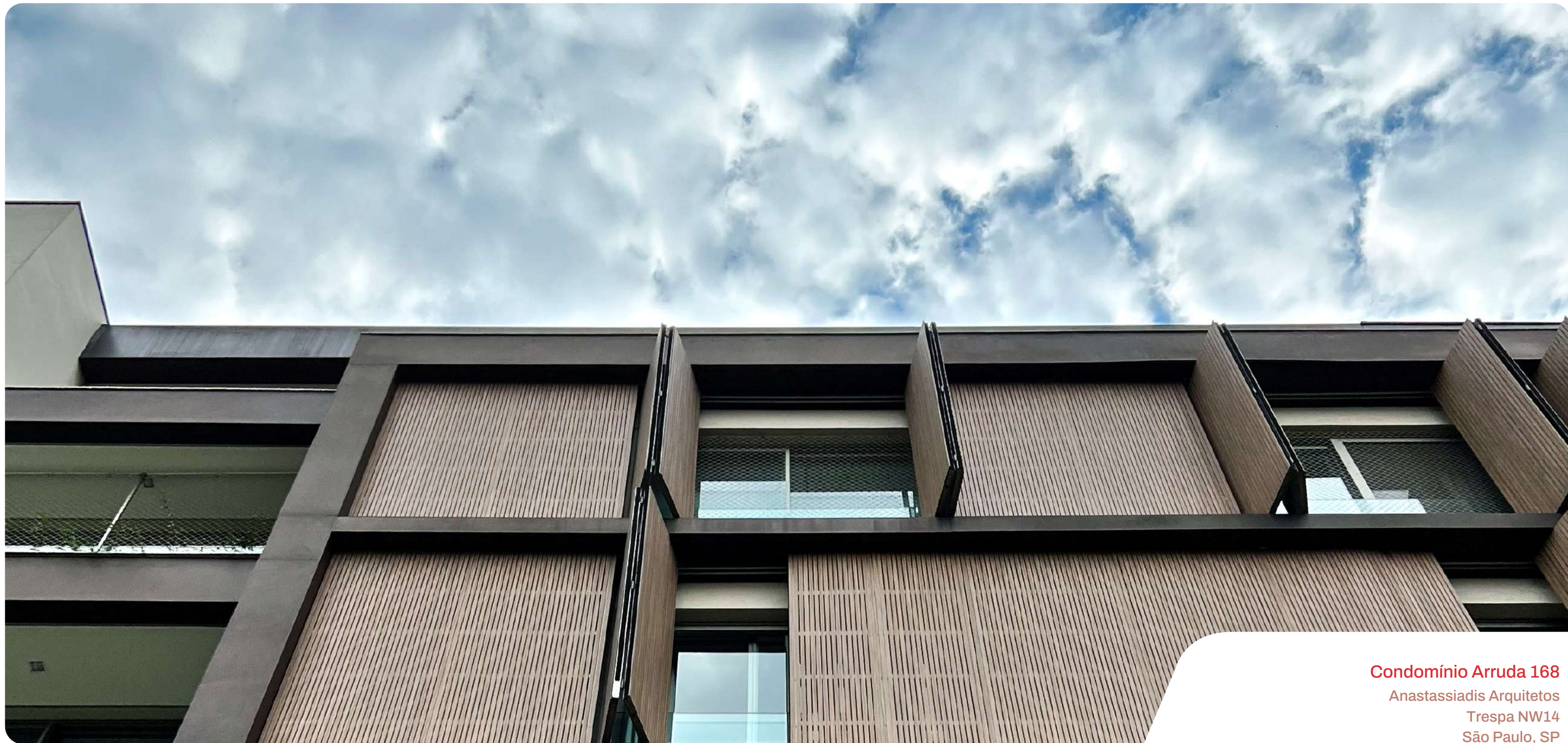

**Condomínio Arruda 168**

Anastassiadis Arquitetos

Trespa NW14

São Paulo, SP

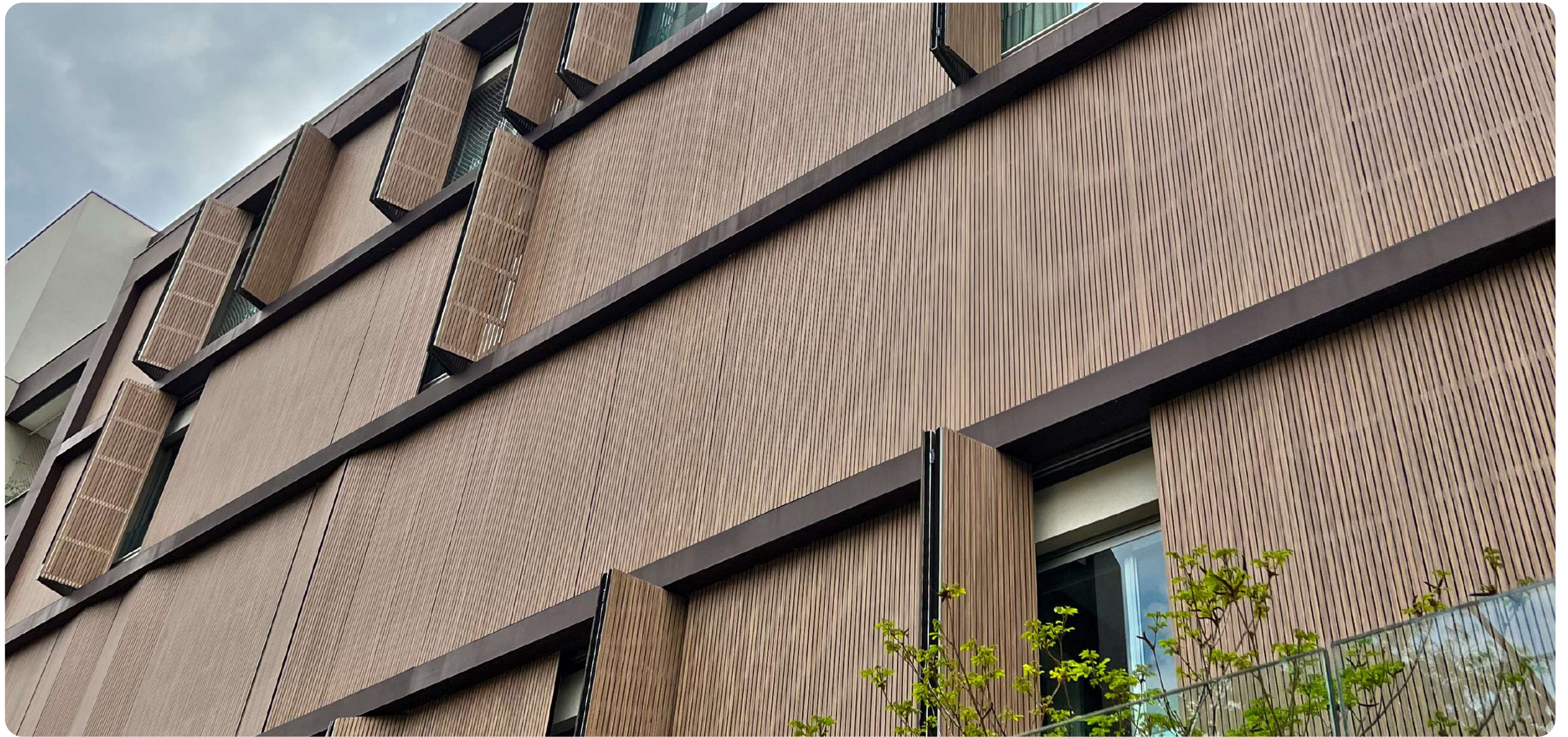

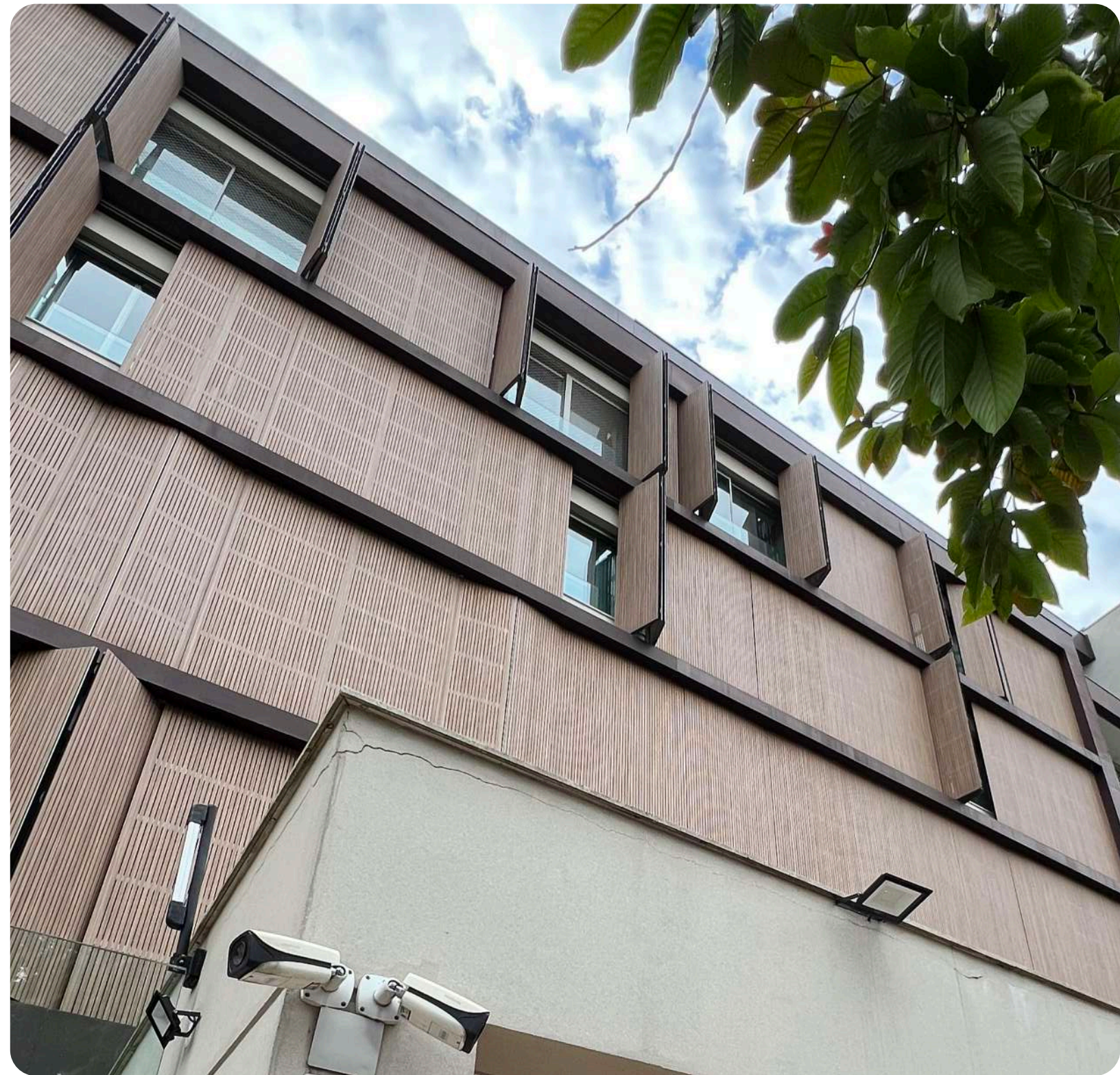



**Casa RMD**

Jacobsen Arquitetura  
Trespa 6mm NW02  
Bragança Paulista, São Paulo







**Casa Nova Lima**

MK27 Arquitetos

Trespa NW14

Nova Lima, MG





**Casa Jaboticaba**

Fernanda Marques Arquitetura

Trespa NW14

São José dos Campos, SP



# ARKOTECH

## VANTAGENS

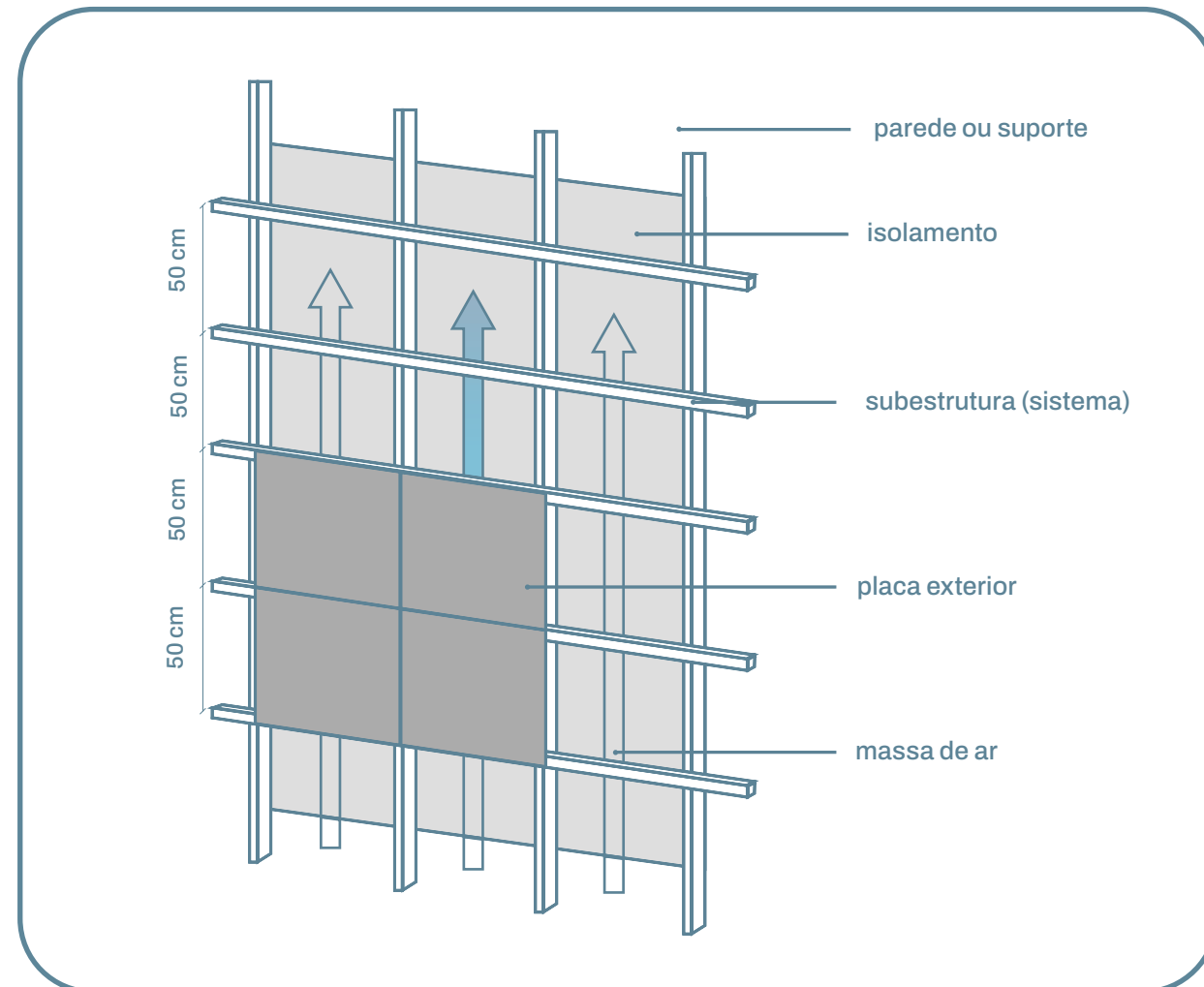

- Maior conforto interno: tanto no calor quanto no frio;
- Uso reduzido de ar-condicionado;
- Bloqueio da radiação solar (isolante térmico);
- Drenagem através da entrada/saída de ar, eliminando problemas de umidade da estrutura;
- Manutenção reduzida na estrutura.

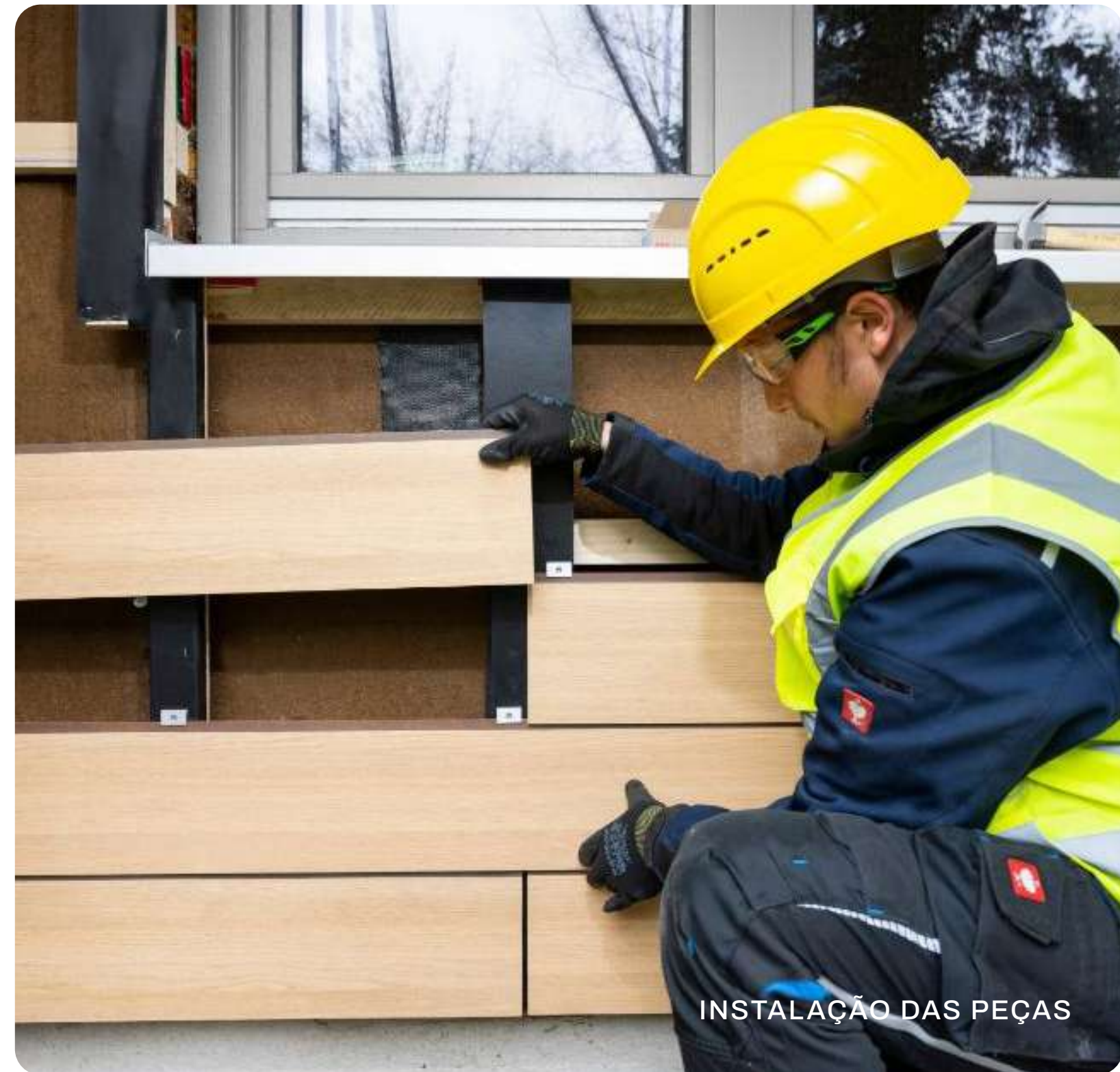
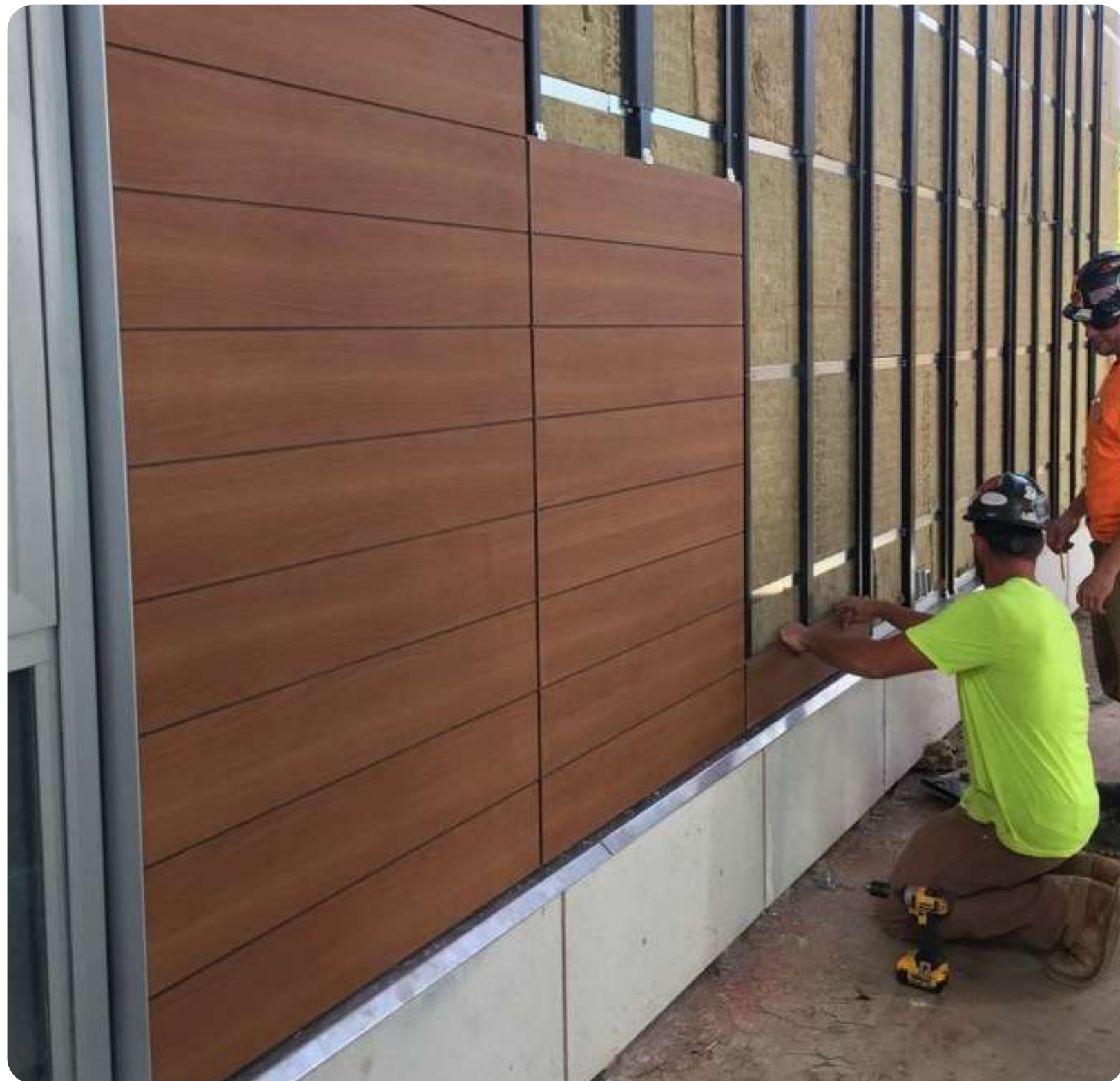

INSTALAÇÃO DAS PEÇAS



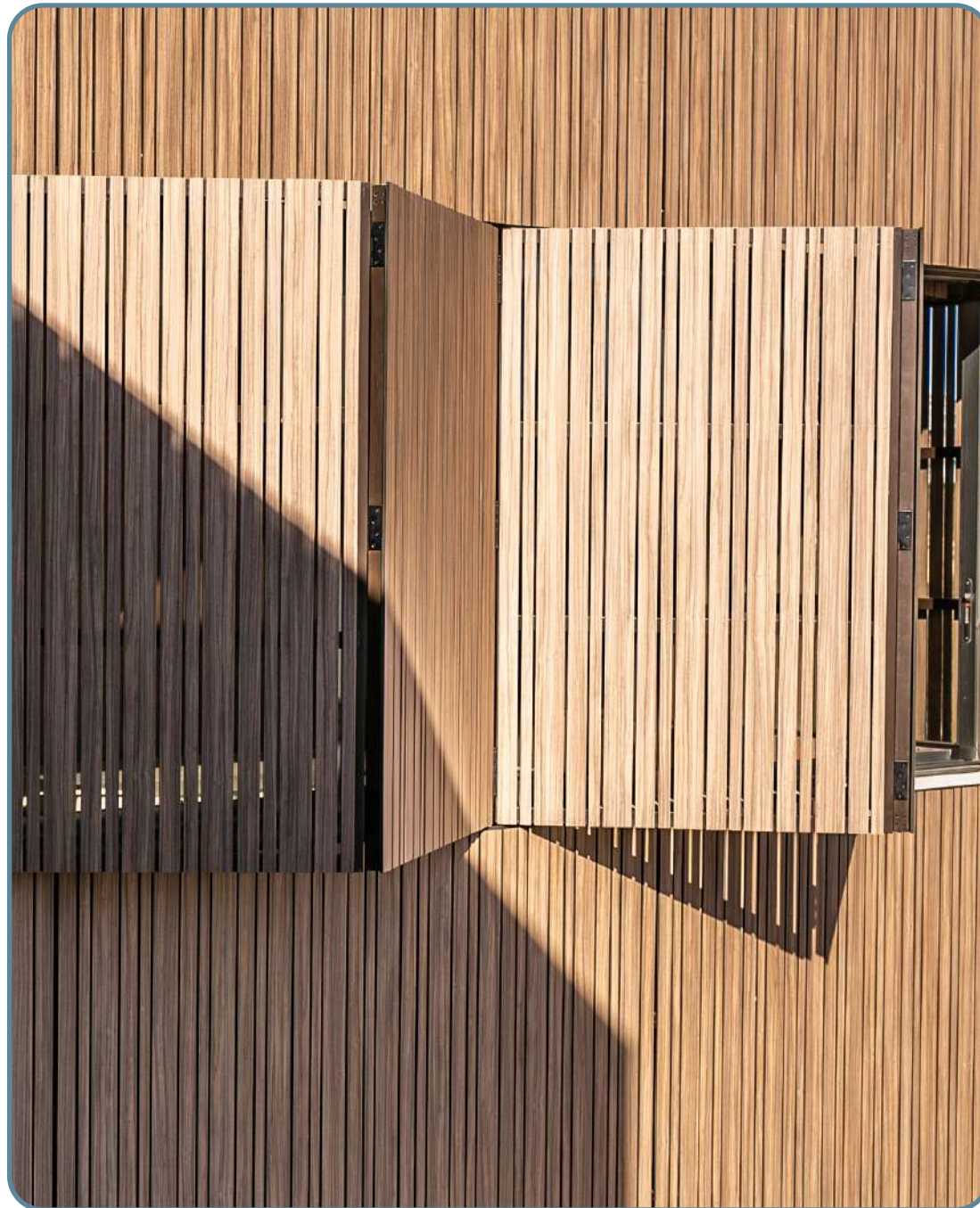
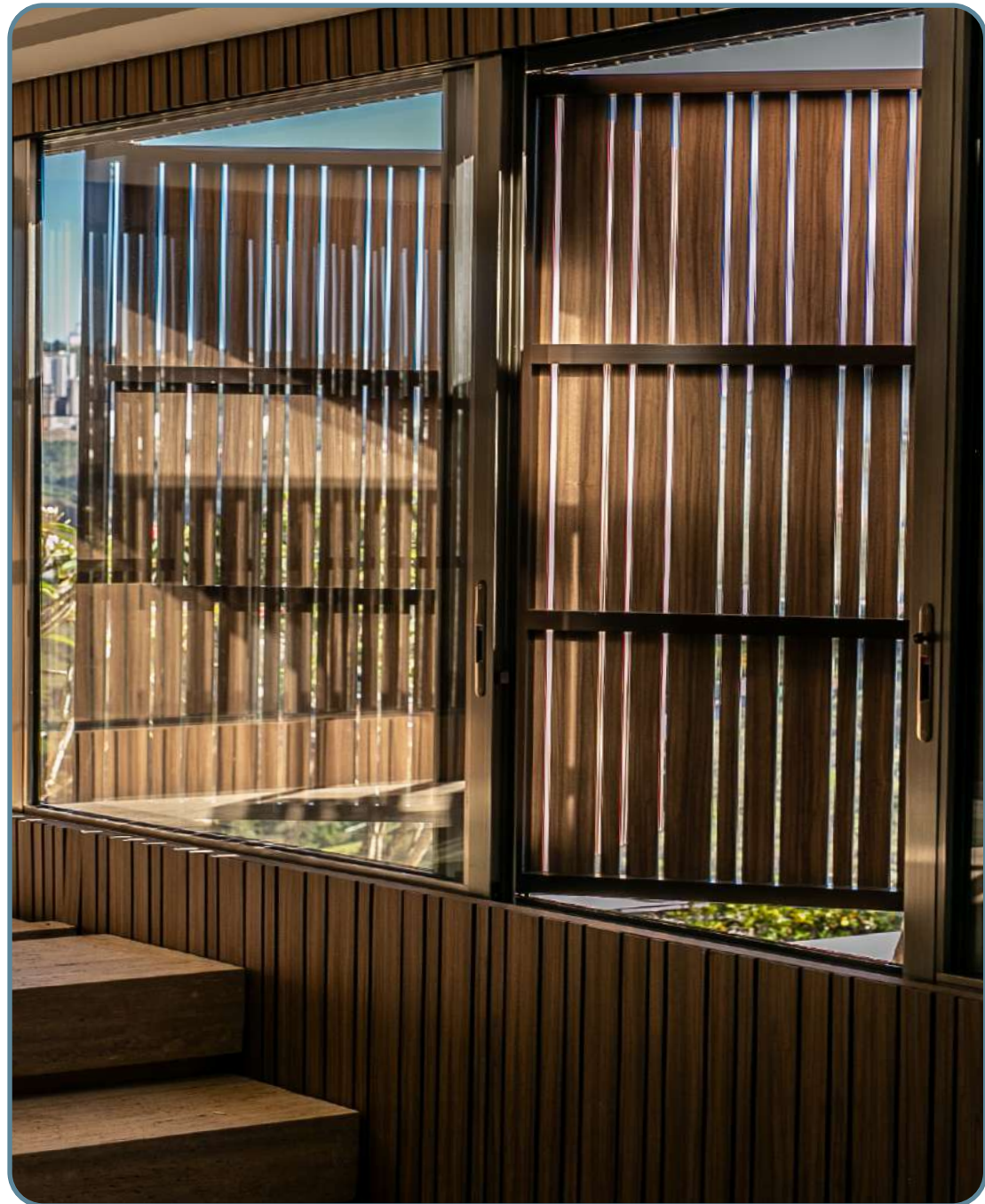

ARKOTECH  
PORTAS E JANELAS CAMARÃO

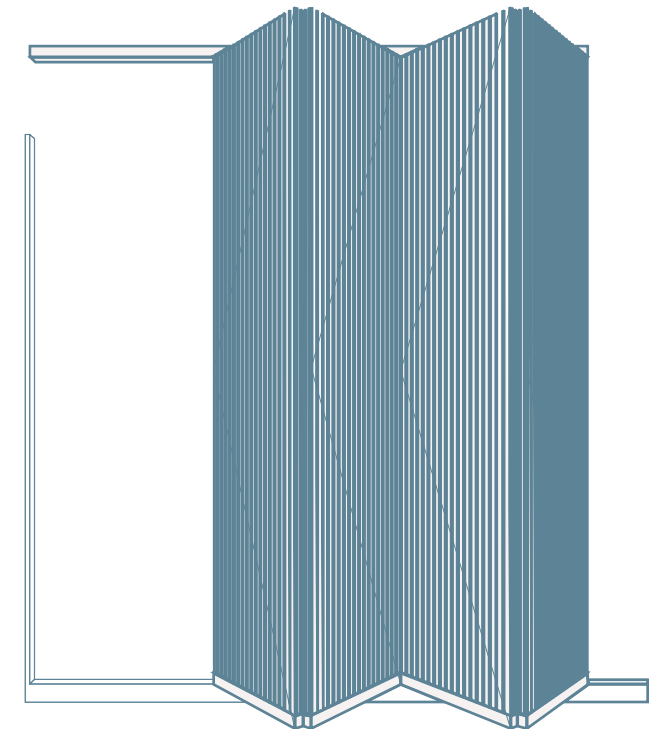



# ARKOTECH

REFORÇO ESTRUTURAL

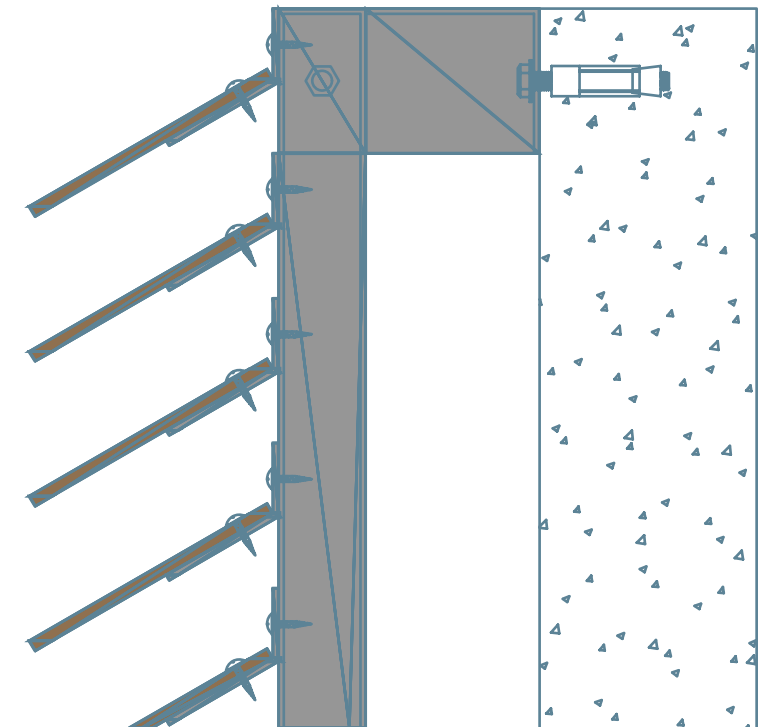

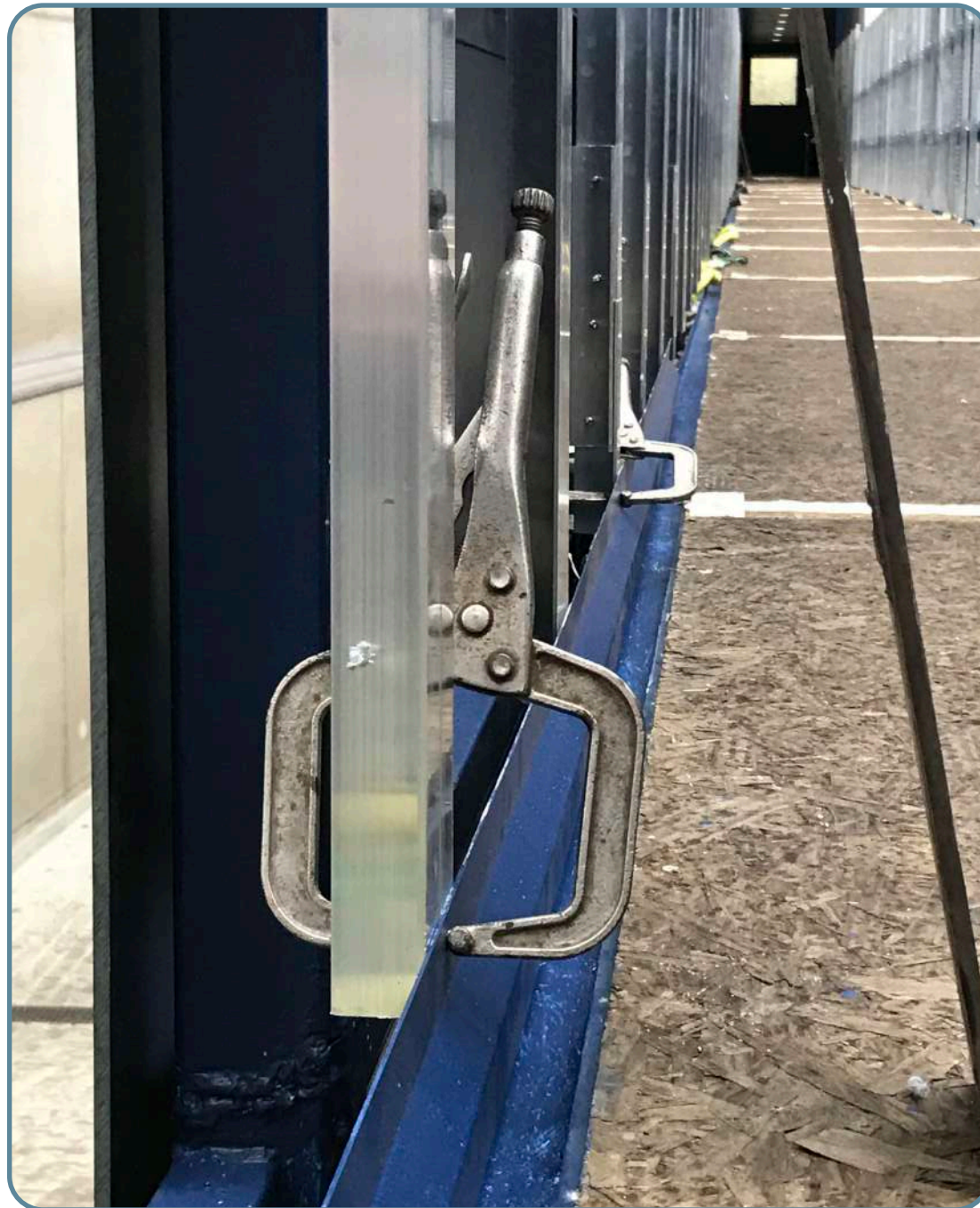

ARKOTECH

JUNTAS

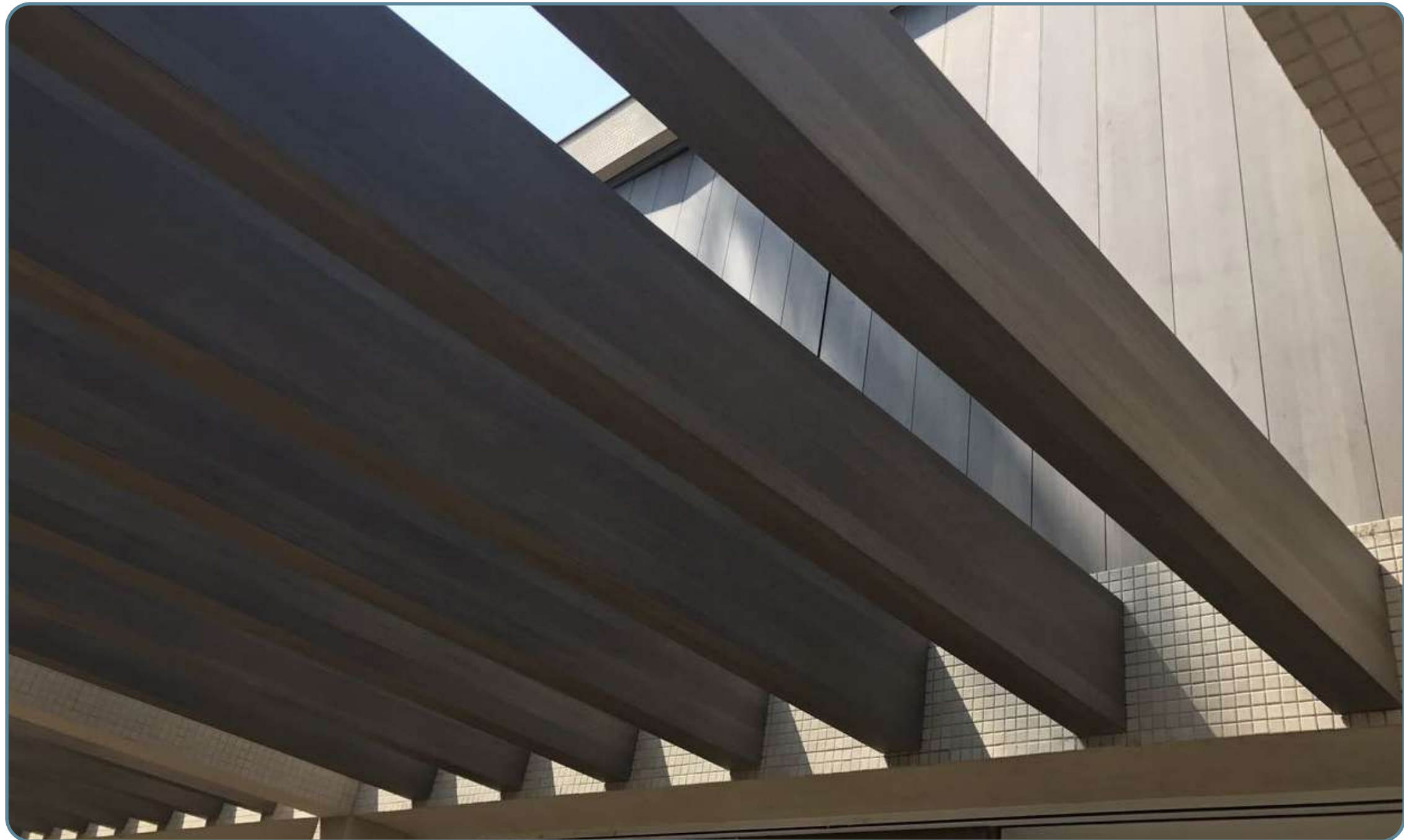

# ARKOTECH

APLICAÇÕES DIFERENCIADAS

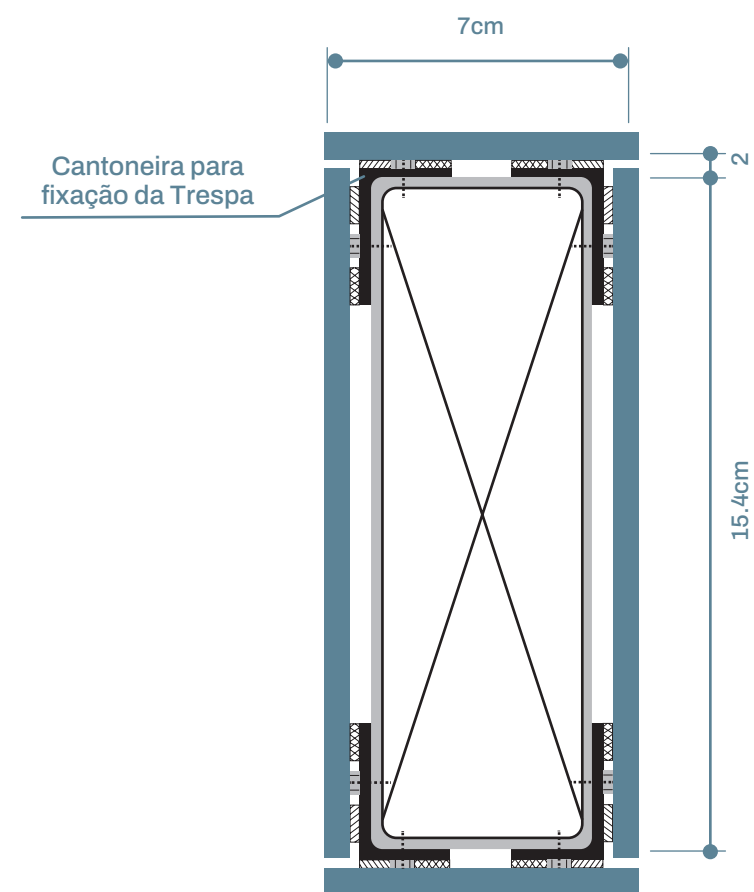

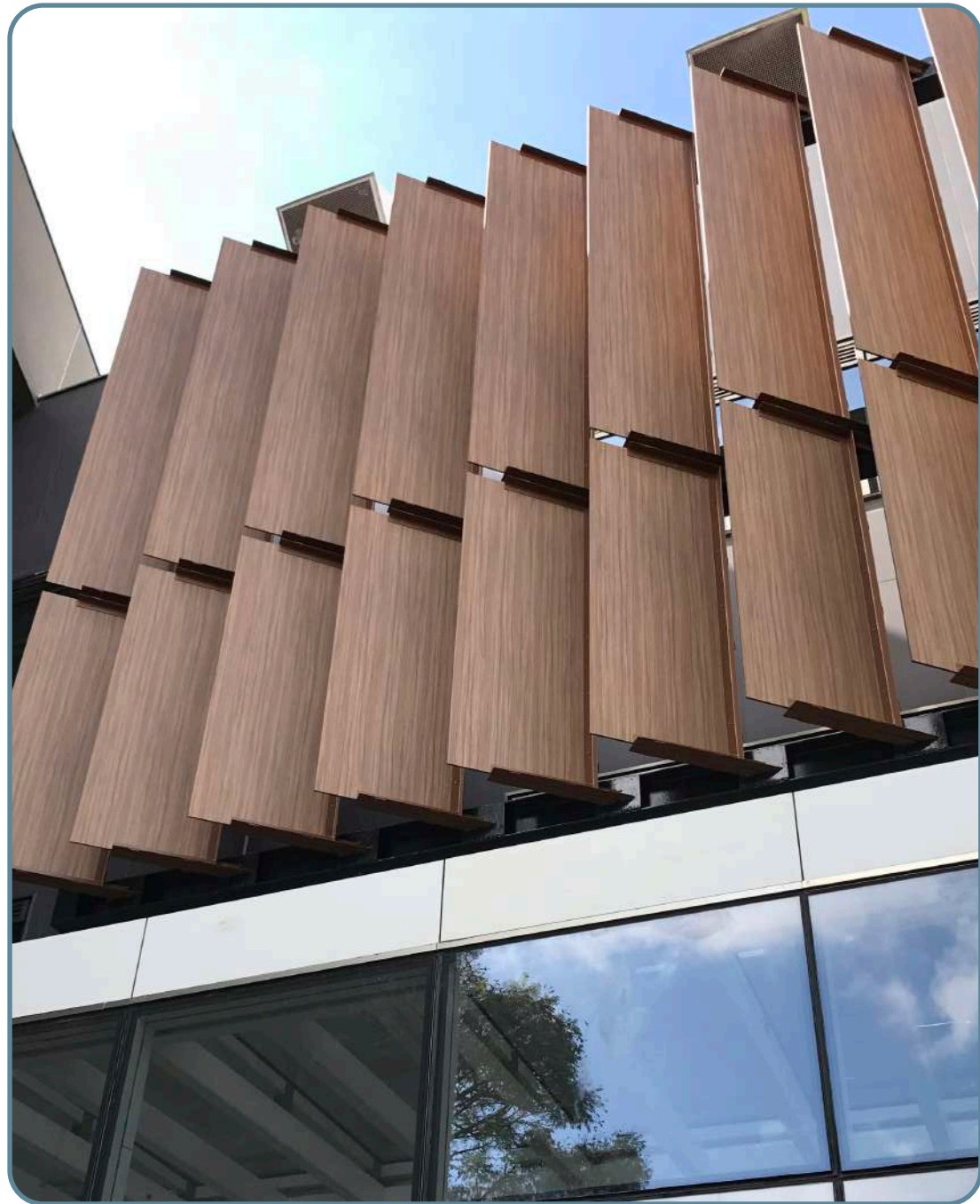

# ARKOTECH

APLICAÇÕES DIFERENCIADAS

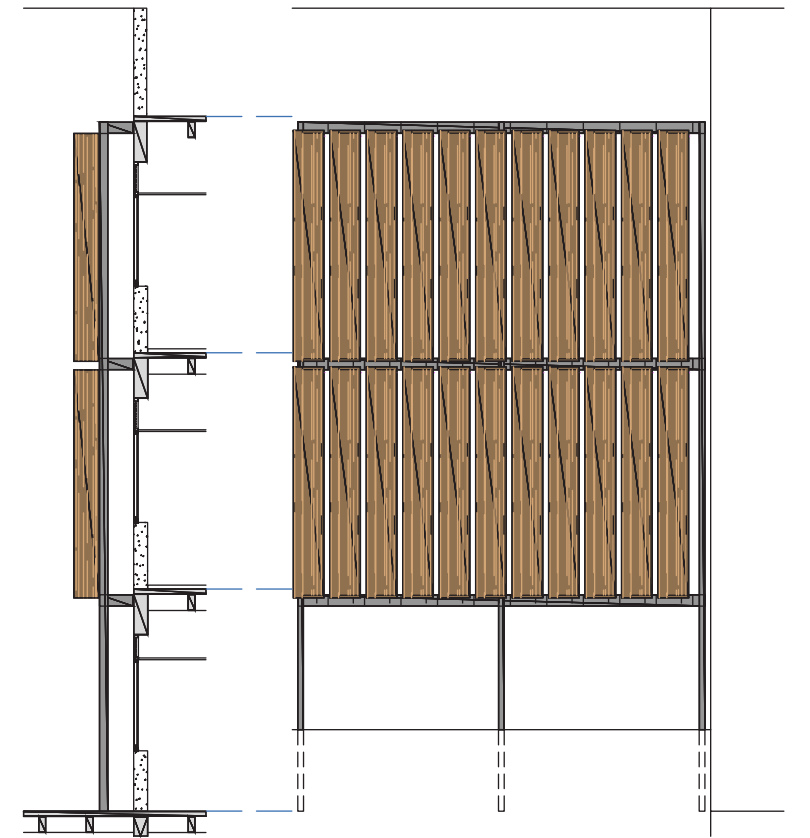

# ARKOTECH

FERRAMENTAS DE INSTALAÇÃO



CORTADOR DE DISCO CIRCULAR



DISCO CIRCULAR PARA MADEIRA



PARAFUSADEIRA COM PARAFUSO  
PERFURANTE DE CABEÇA CHATA

# ARKOTECH

---

## RECOMENDAÇÕES DE USO E MANUTENÇÃO

Não bata no material durante a descarga e segure-o muito bem durante o transporte, armazene o produto em paletes ou bases firmes, uniformes e rígidas, não exceda 40 unidades na vertical ao empilhar e não descanse elementos pesados sobre o produto armazenado.

Proteja-o dos elementos com materiais não translúcidos: polietileno preto, papelão ou materiais similares, garantindo fluxo contínuo de ar. Se houver contaminação, limpe imediatamente removendo qualquer substância derramada, não utilize produtos abrasivos e não esfregue, molhe-o com água quente e seque com um pano macio. Pode ser lavado à pressão, com uma recomendação de pressão máxima de 1100 PSI, sempre adote as medidas de segurança necessárias e evite danos ao material.

**AMANTES DE BOA ARQUITETURA**

arkos

[www.arkosbrasil.com.br](http://www.arkosbrasil.com.br)

 arkosbrasil



 +5511971196692