

arkos

ARKOWOOD MP

MATTE

REVESTIMENTOS DE DISTINTAS MORFOLOGIAS COMPOSTOS
DE MADEIRA ECOLÓGICA PARA INTERIORES

CONO FELIZ
Un Sabor 6200
Dos Sabores 7900
Galleta con Helado 9900
Brownie con Helado 11900
Malteda 14900
+ 1800 IVA BARRIO SUR
@CONOFELIZDELACRIBA



Características

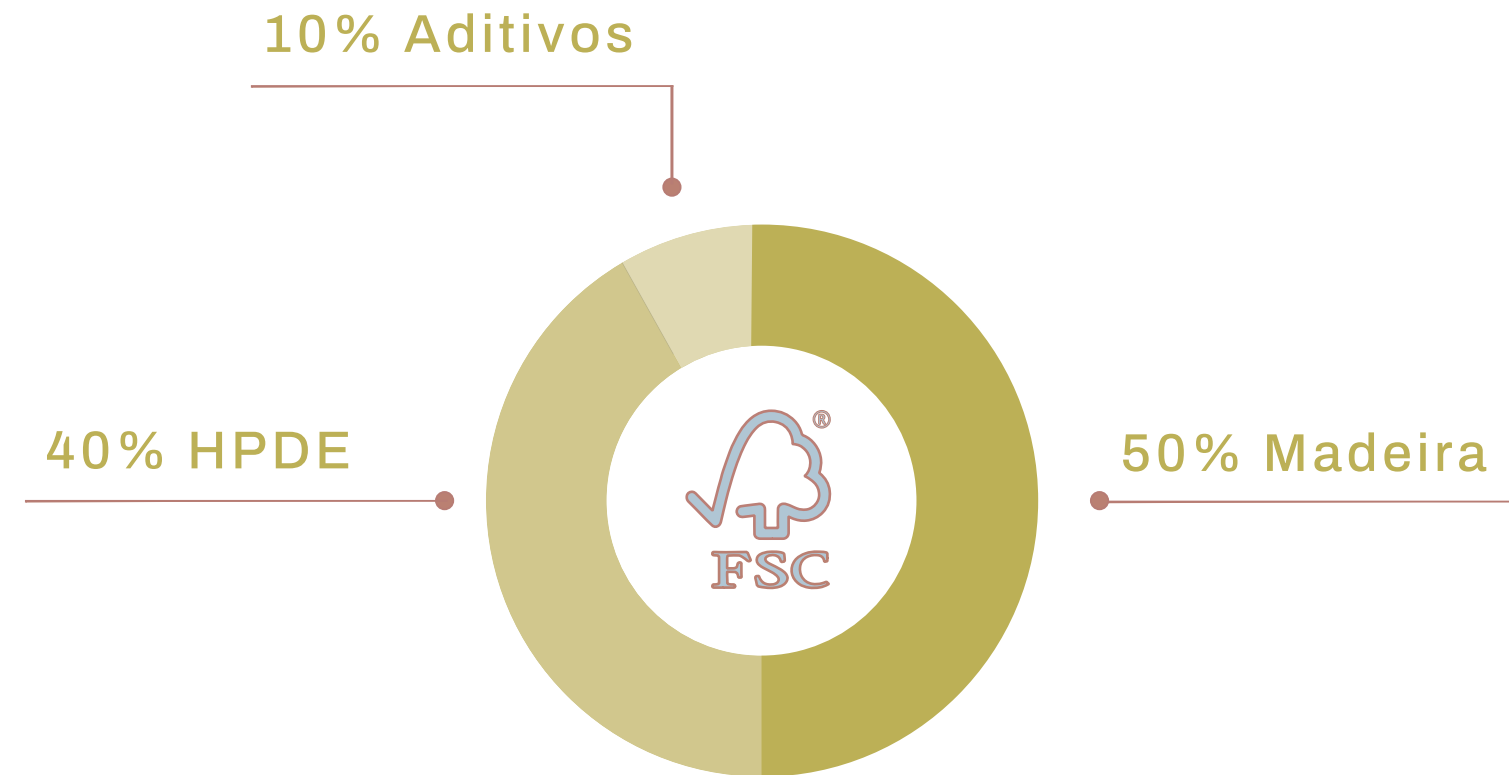

Revestimentos compostos de madeira ecológica, HDPE e aditivos, certificado pelo selo FSC de responsabilidade ambiental, desenhados para aplicação em **áreas internas**.

Características

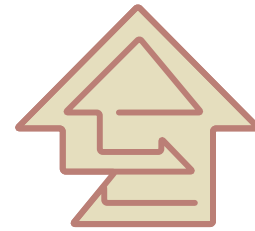

Alta durabilidade

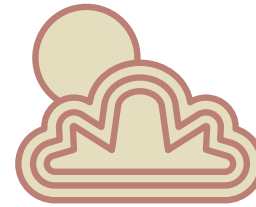

Aplicável em todos os tipos de clima

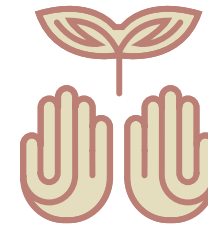

Responsabilidade ambiental

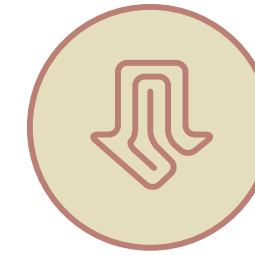

Fácil instalação

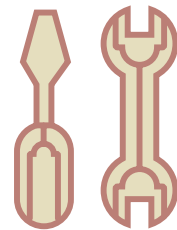

Não requer manutenção

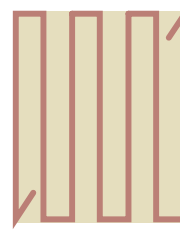

Produto sustentável

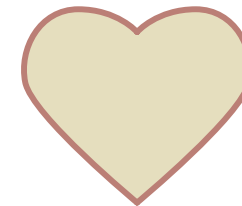

Vida útil de mais de 20 anos



Garantia de 10 anos

ARKWOOD MP

PALETA DE CORES MATTE



LPM5201

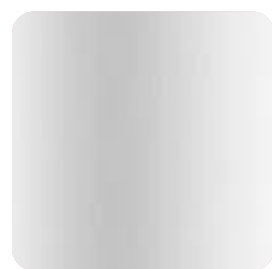

LPM6004



LPM3005



LPM3001



LPM2001

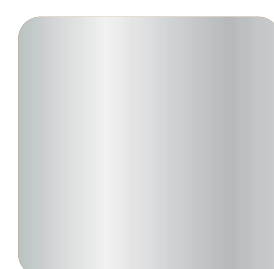

LPM4001



LPM3005



LPM6005



LPW1010

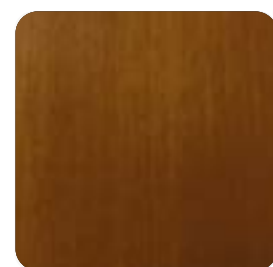

LPW1011

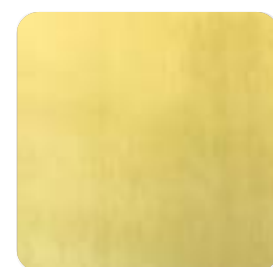

LPW1013

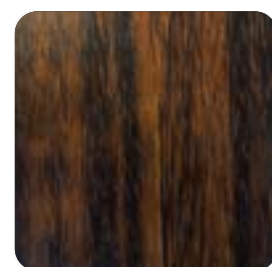

LPW1014

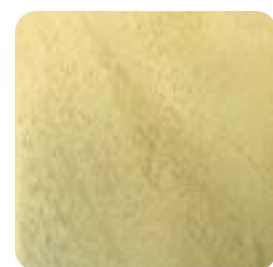

LPW1015

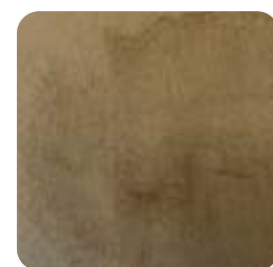

LPW1016

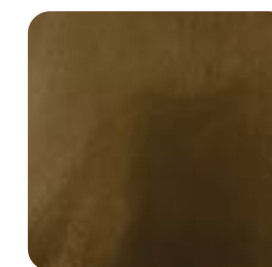

LPW1017

Podem ocorrer variações de preços de acordo com a cor. Consulte-nos através do [WhatsApp](#).

ARKOS

ARKWOOD MP

PALETA DE CORES MATTE

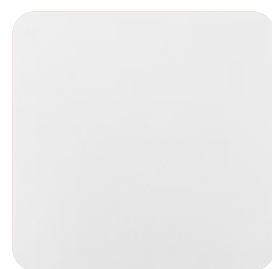

LPF1004

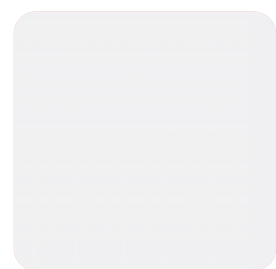

LPF2036



LPF1016



LPF1012

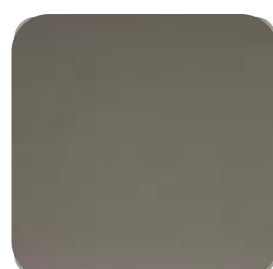

LPF1010



LPF1008



LPF1007



LPF1015



LPF1013

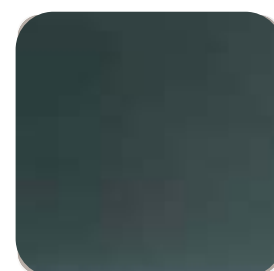

LPF1006

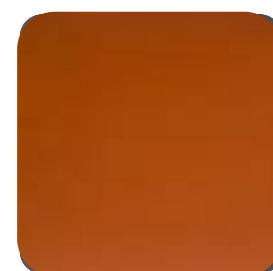

LPF1009



LPF1014



LPF1011

Podem ocorrer variações de preços de acordo com a cor. Consulte-nos através do [WhatsApp](#).

ARKOS

arkWOOD MP

RIPADOS

ARKWOOD MP

SEÇÕES DISPONÍVEIS

ARKWOOD MP12
Metro quadrado a R\$ 497,00

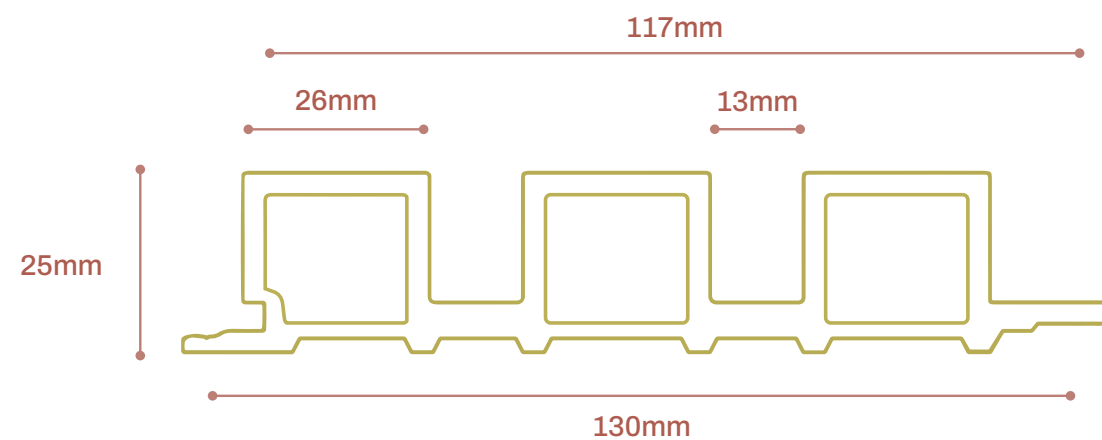

ARKWOOD MP15
Metro quadrado a R\$ 436,00

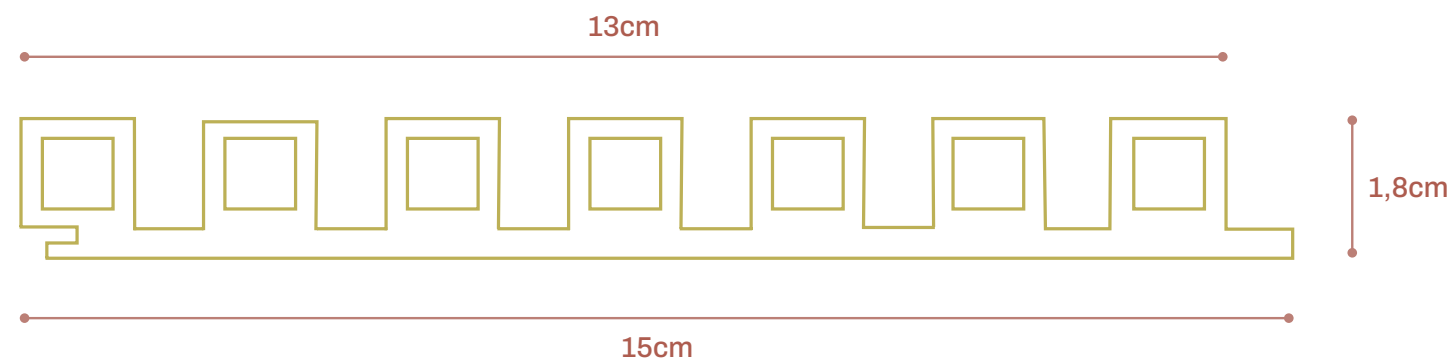

Comprimento de régua: 2,90m até 4,00m (podendo estender até 5,80m sob encomenda)

ARKWOOD MP
SEÇÕES DISPONÍVEIS



ARKWOOD MP 12

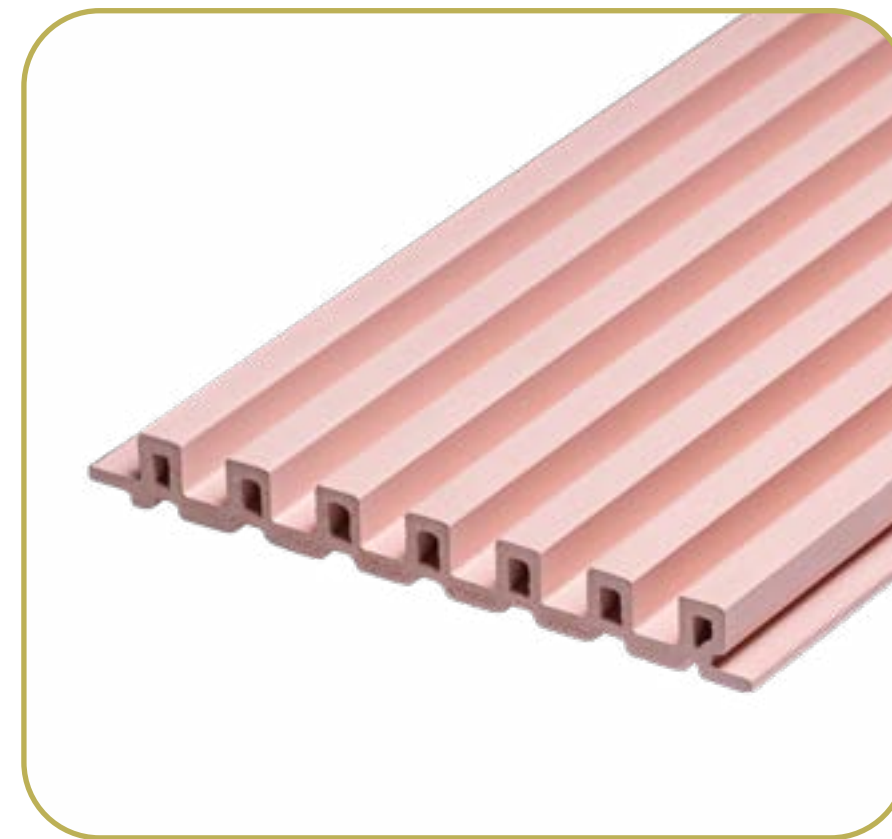

ARKWOOD MP 15



CONO FELIZ

Un Sabor 8200
Dos Sabores 2900
Café con Helado 9900
Brownie con Helado 11900
Molletes 14900

1875 45 5000 1



WELCOME TO THE WORLD





ARKWOOD MP

INSTALAÇÃO

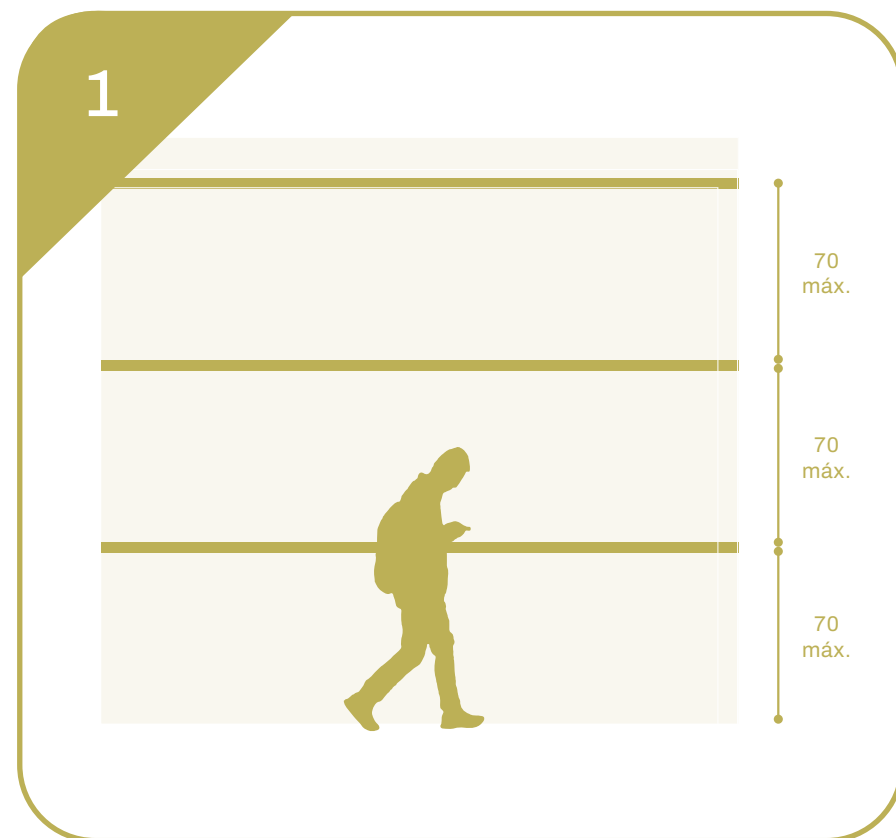

Aplicação do produto tendo em conta um distanciamento entre apoios de 70cm e furo conforme as medidas e aplicação das buchas segundo a superfície de instalação.

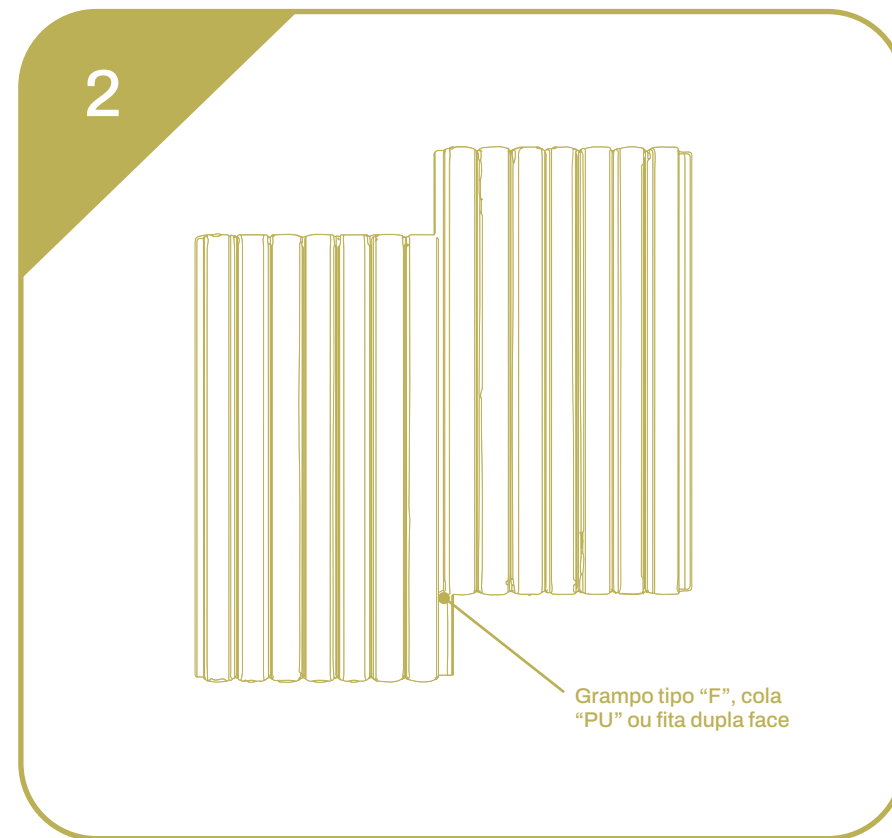

Parafusagem das cantoneiras com parafuso auto brocante e instalação dos perfis sobre as mesmas, assegurando-se de que estão niveladas.

(Não inclui elementos acessórios e mão-de-obra)

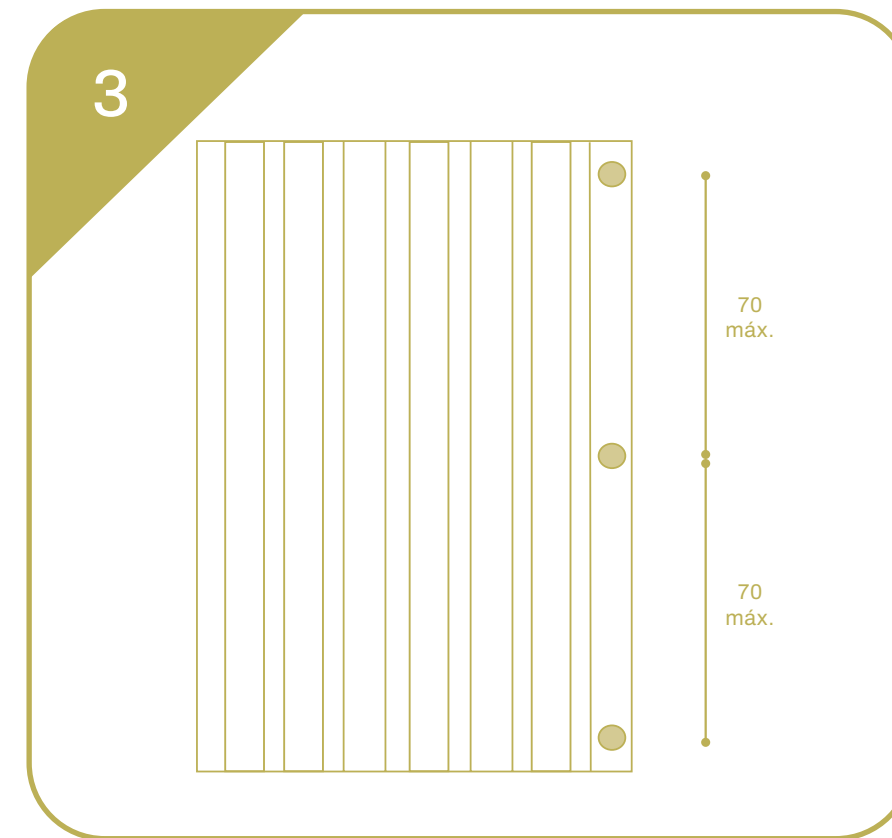

Parafusagem de cada régua nos perfis e encaixe das mesmas em sequência, formando o painel ripado.

ARKOWOOD MP

INSTALAÇÃO SOBRE OSB, FIBROCIMENTO, TRIPLAX E DRYWALL

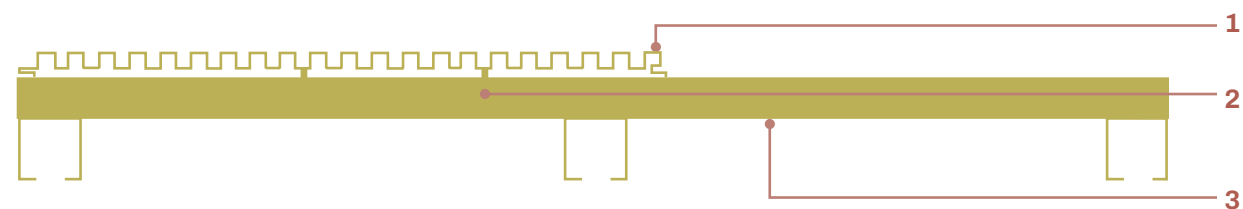

- 1 - Arkowood MP
- 2 - Grampo tipo "F"
- 3 - OSB, Fibrocimento, Triplax ou Drywall



Instalação deve **SEMPRE** começar pela parte "macho" do material.

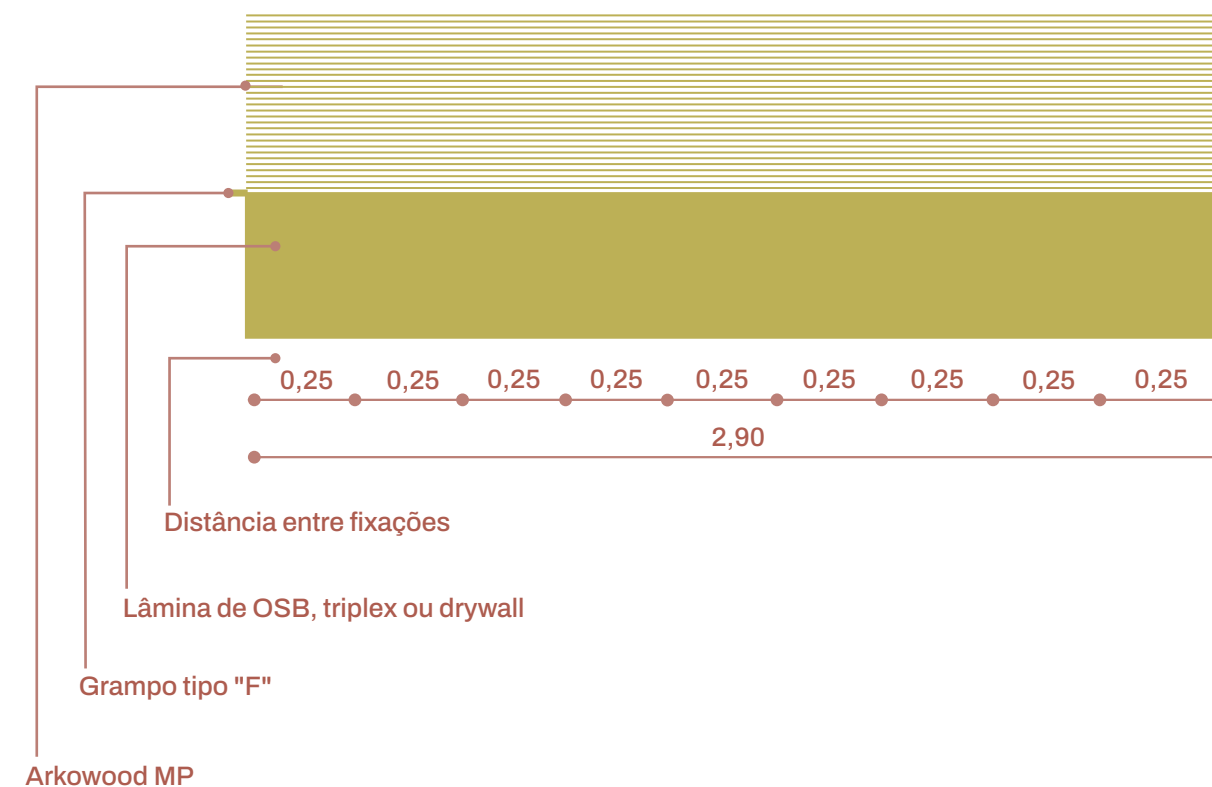

Use uma fita de espuma estrutural de 1"x3 mm ou similar para fixar a peça inicial;
Evite a exposição do grampo.

ARKOWOOD MP

INSTALAÇÃO SOBRE ALVENARIA

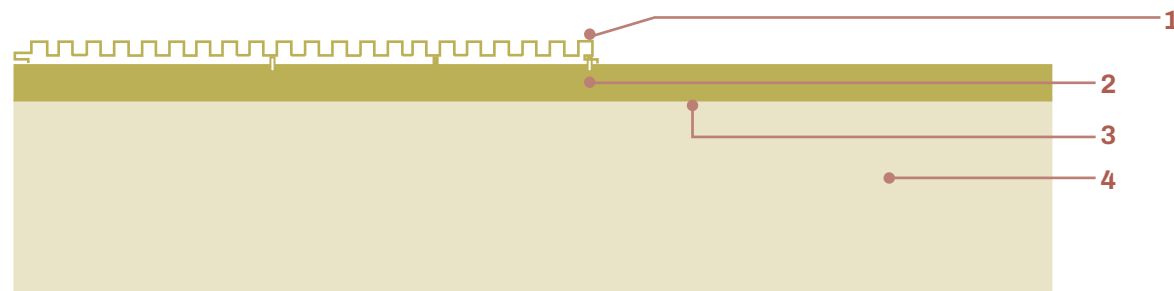

- 1 - Ripado de OSB esp. 09mm x2"
- 2 - Grampo tipo "F"
- 3 - OSB, Fibrocimento, Triplax ou Drywall
- 4 - Alvenaria



Instalação deve SEMPRE começar pela parte do Arkowood P.

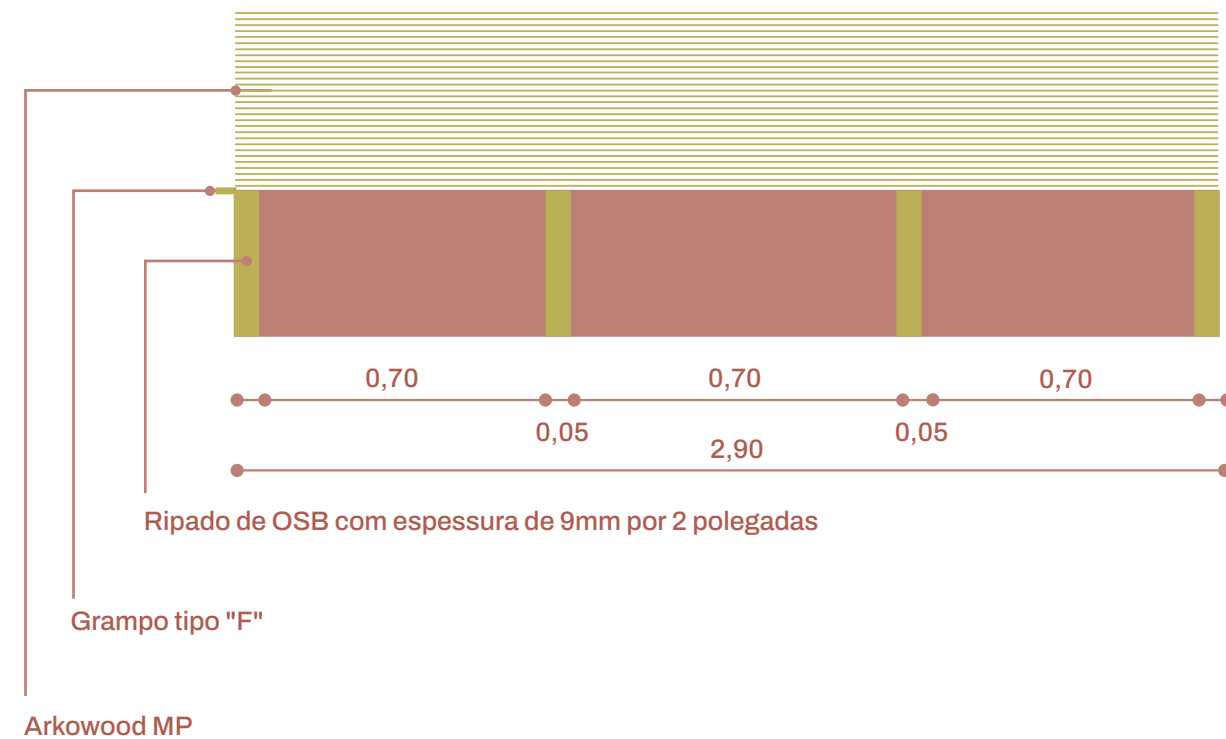

Ripado de OSB com espessura de 9mm por 2 polegadas

Grampo tipo "F"

Arkowood MP

Use uma fita de espuma estrutural de 1"x3 mm ou similar para fixar a peça inicial;
Evite a exposição do grampo.

arkWOOD MP

CÔNCAVOS

ARKWOOD MP

SEÇÕES DISPONÍVEIS

ARKWOOD MP51
Metro quadrado a R\$ 706,00

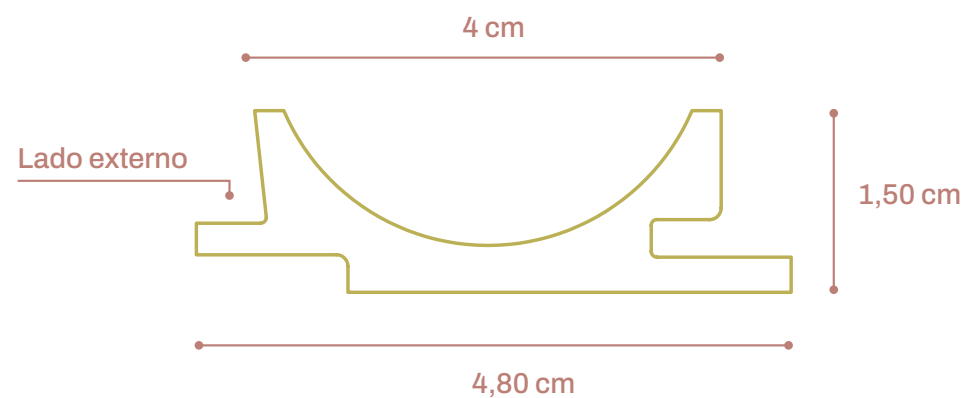

ARKWOOD MP68
Metro quadrado a R\$ 501,00

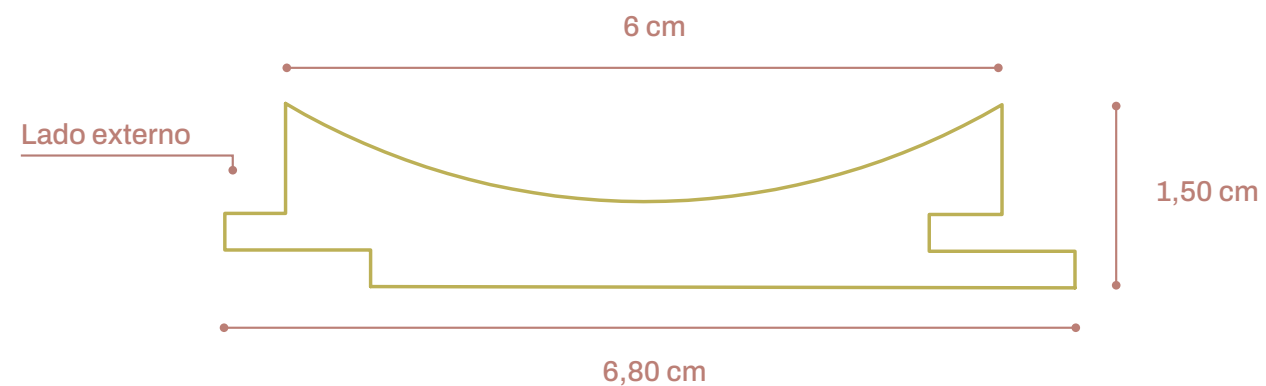

ARKWOOD MP130
Metro quadrado a R\$ 530,00

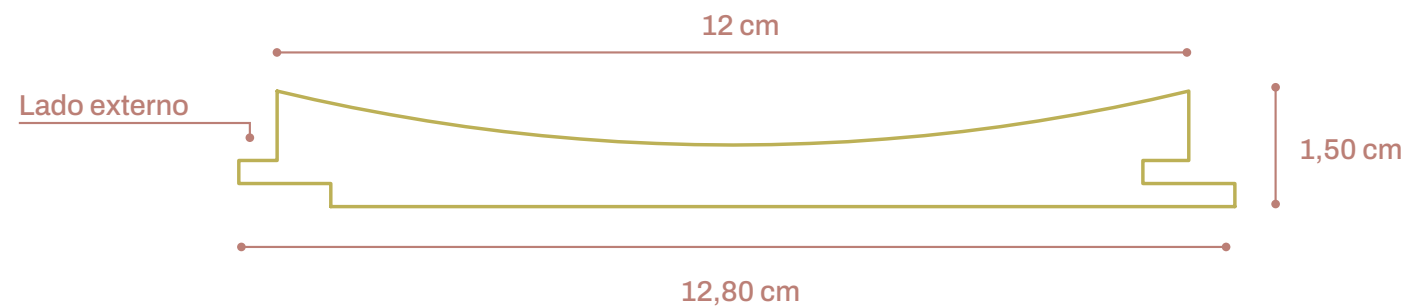

Comprimento de régua: 2,90m até 4,00m (podendo estender até 5,80m sob encomenda)

ARKWOOD MP
SEÇÕES DISPONÍVEIS



ARKWOOD MP 51



ARKWOOD MP 68



ARKWOOD MP 130





ARKWOOD MP

INSTALAÇÃO

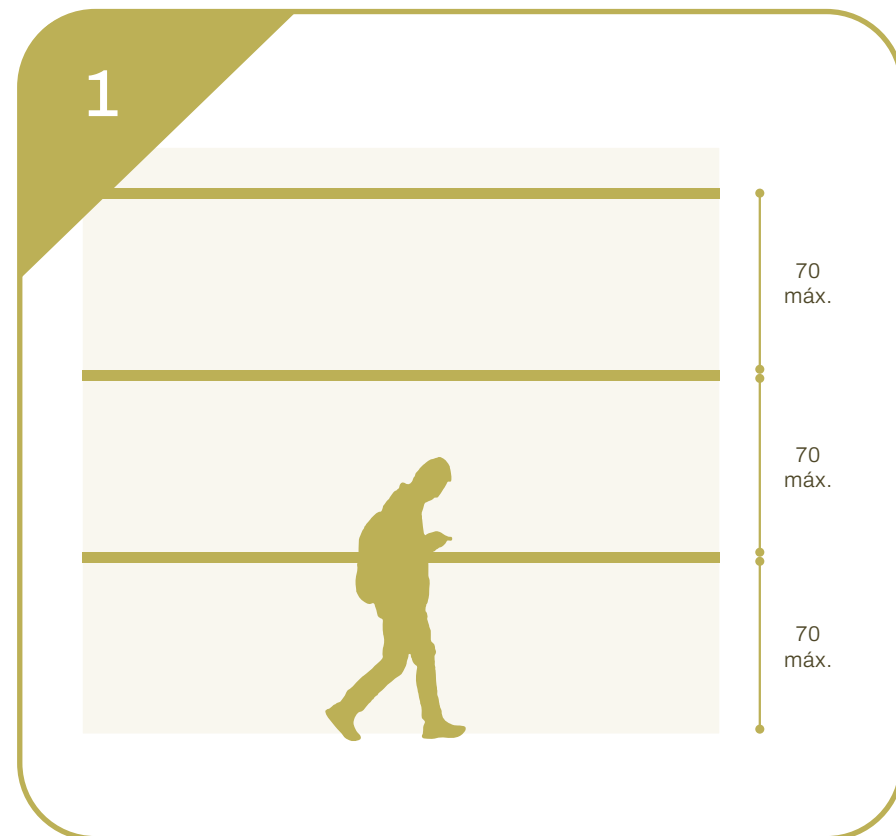

1
APLICAÇÃO DO PRODUTO TENDO EM CONTA UM DISTANCIAMENTO ENTRE APOIOS DE 70CM E FURO CONFORME AS MEDIDAS E APLICAÇÃO DAS BUCHAS SEGUNDO A SUPERFÍCIE DE INSTALAÇÃO.

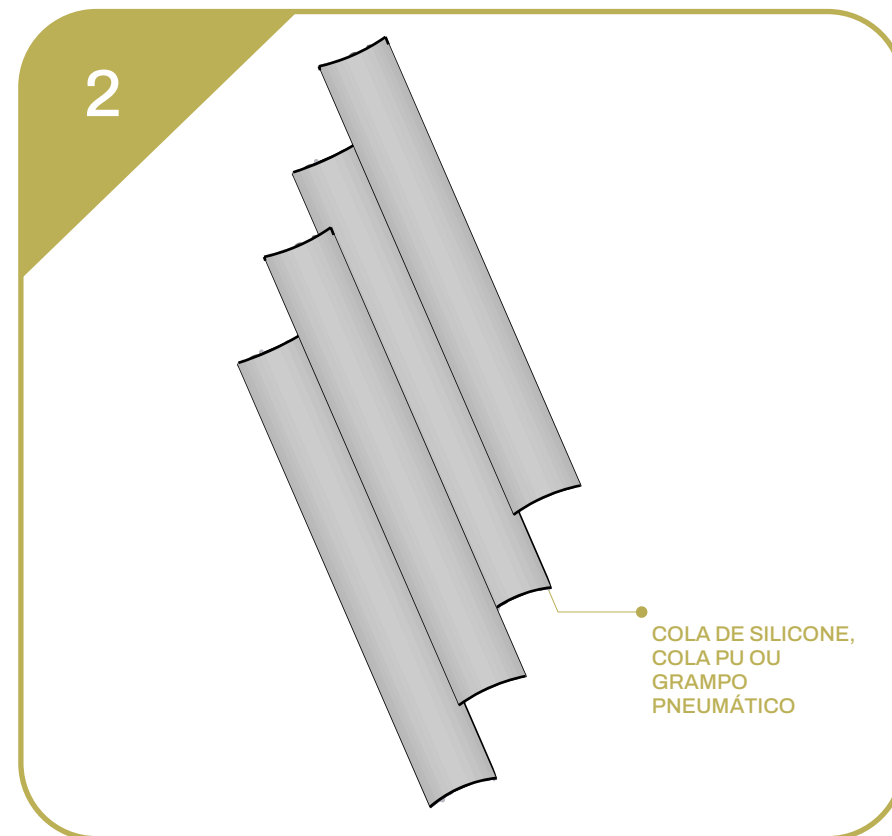

2
COLOCAÇÃO DA PRIMEIRA RÉGUA E APLICAR SISTEMA DE FIXAÇÃO A ESCOLHER. INSTALAÇÃO DAS DE MAIS RÉGUAS, ASSEGURANDO-SE DE QUE ESTÃO NIVELADAS.

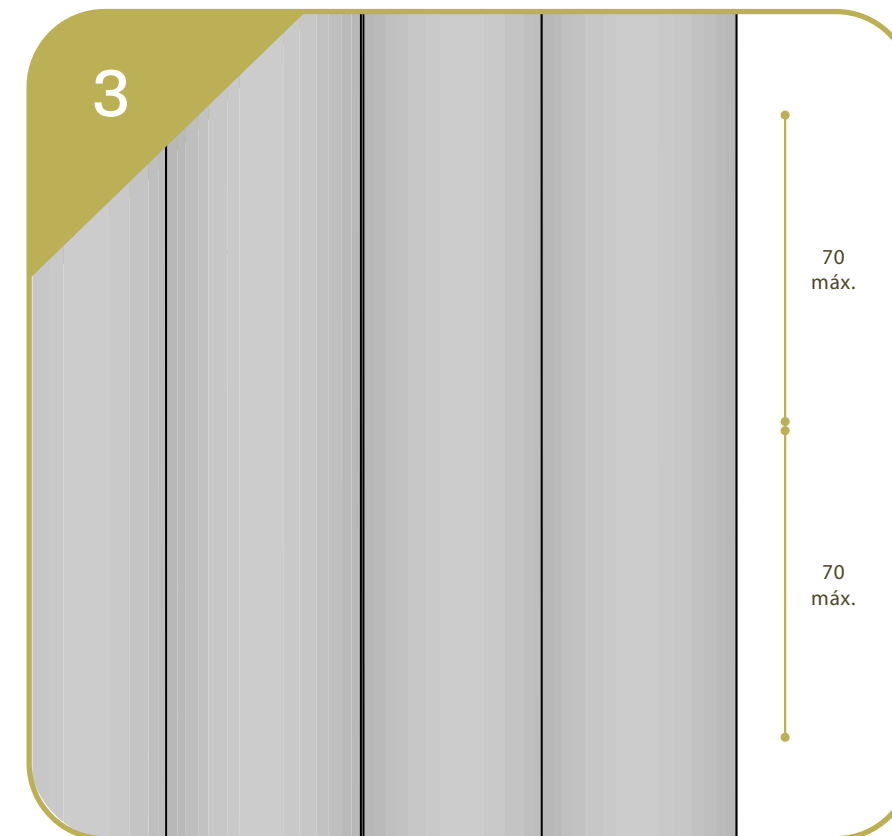

3
PARAFUSAÇÃO DE CADA RÉGUA NOS PERFIS E ENCAIXE DAS MESMAS EM SEQUÊNCIA, FORMANDO O PAINEL RIPADO.

Não inclui elementos acessórios e mão-de-obra.



VIDEO DE

INSTALAÇÃO SOBRE OSB, FIBROCIMENTO, TRIPLAX E DRYWALL (Não inclui elementos acessórios e mão-de-obra)

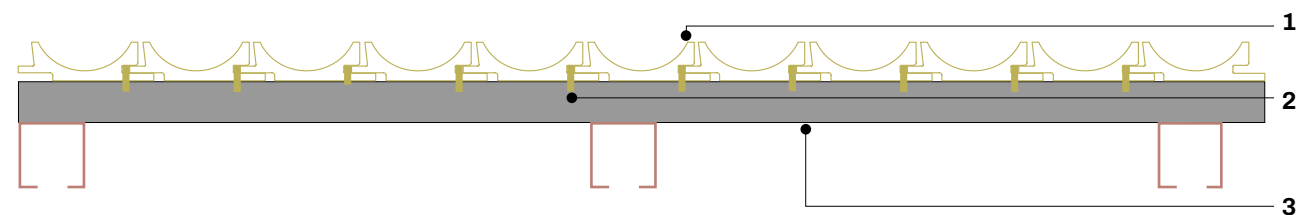

1 - Arkowood M

2 - Grampo tipo "F"

3 - OSB, Fibrocimento, Triplax ou Drywall

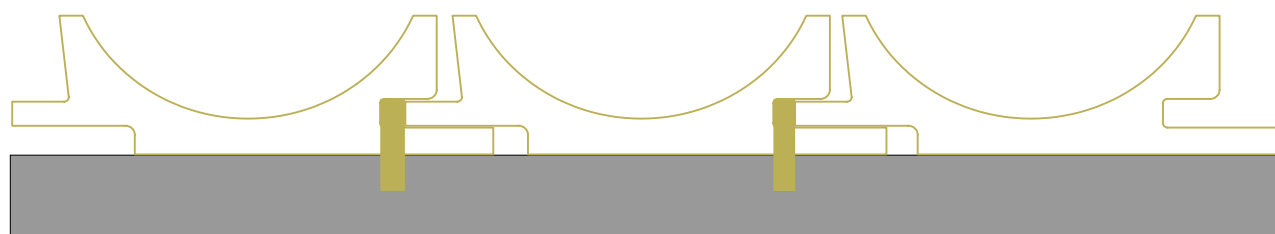

Instalação deve SEMPRE começar pela parte "macho" do material;

Use uma fita de espuma estrutural de 1"x3 mm ou similar para fixar a peça inicial;

Evite a exposição do grampo

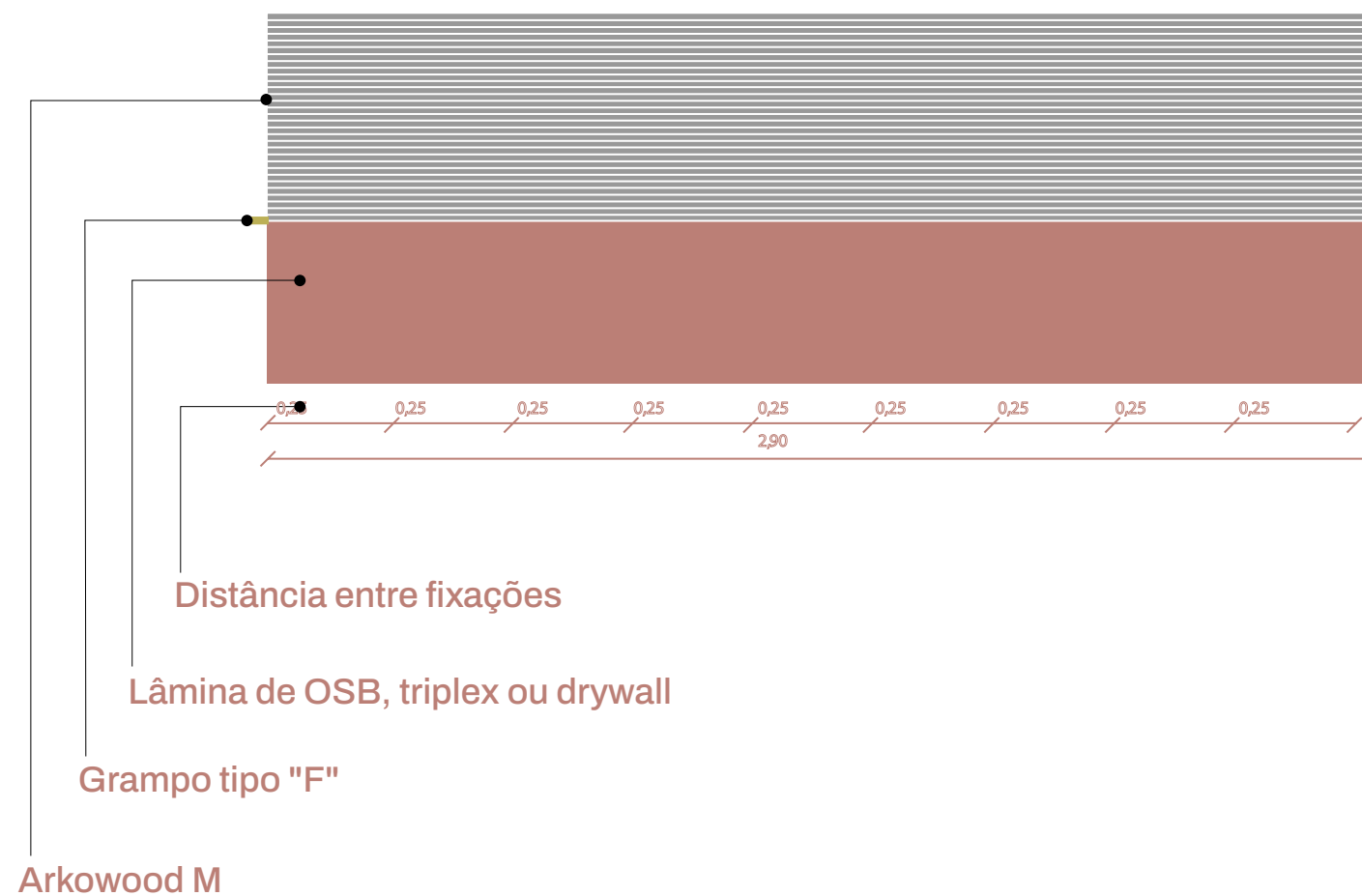

SISTEMA DE FIXAÇÃO
ARKOWOOD MP

arkWOOD MP

CHAPAS ONDULADAS

ARKOWOOD MP

SEÇÕES DISPONÍVEIS

ARKOWOOD MP20 REGULAR
Metro quadrado a R\$ 530,00

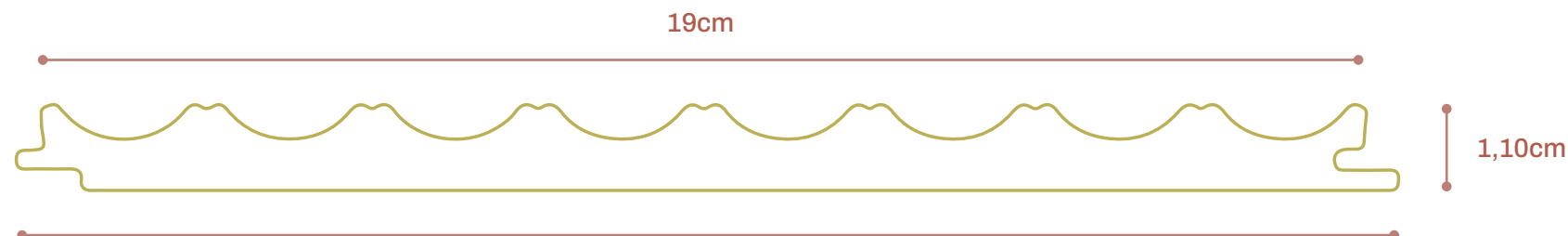

ARKOWOOD MP20 IRREGULAR
Metro quadrado a R\$ 530,00

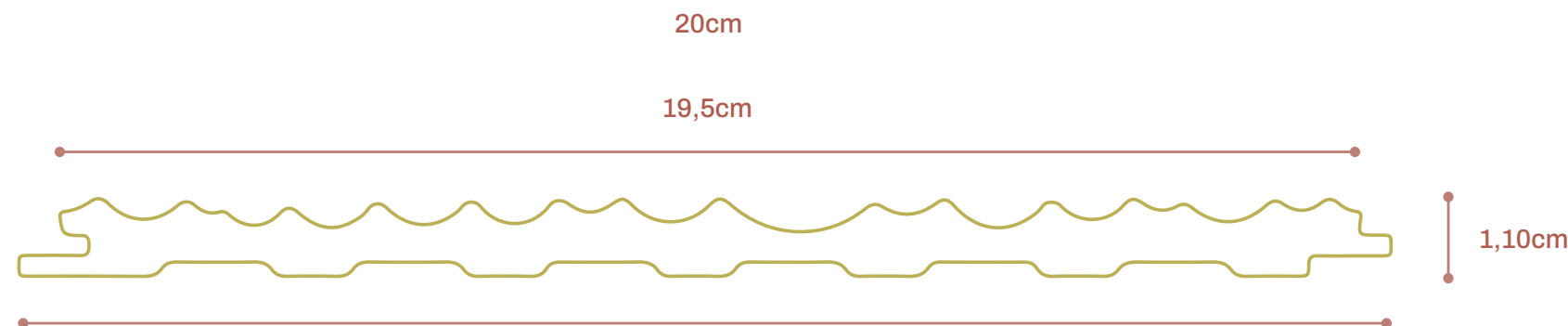

ARKOWOOD MPC
Metro quadrado a R\$ 508,00

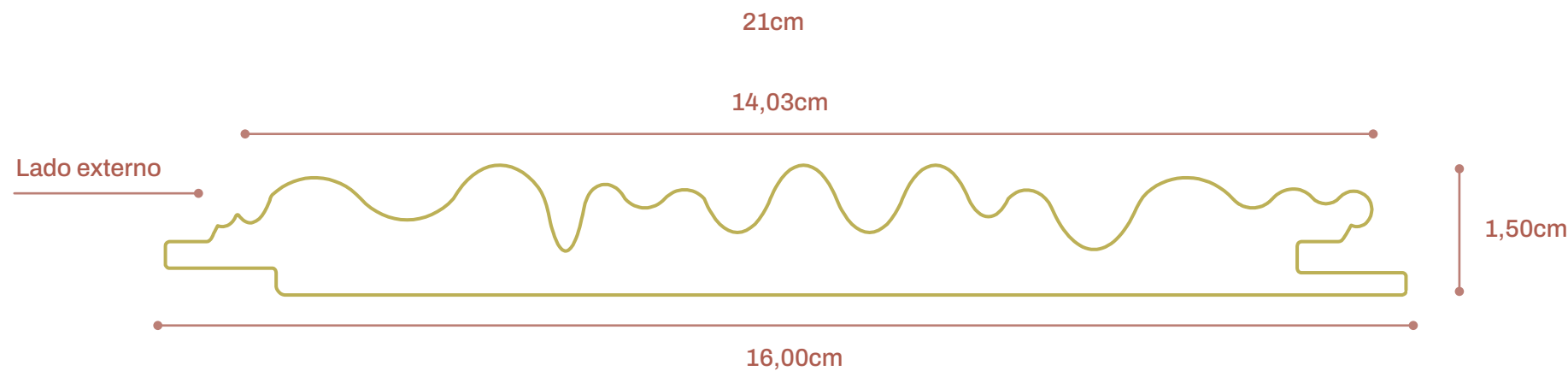

Comprimento de régua: 2,90m até 4,00m (podendo estender até 5,80m sob encomenda)

ARKOWOOD MP
SEÇÕES DISPONÍVEIS



ARKOWOOD MP20 REGULAR

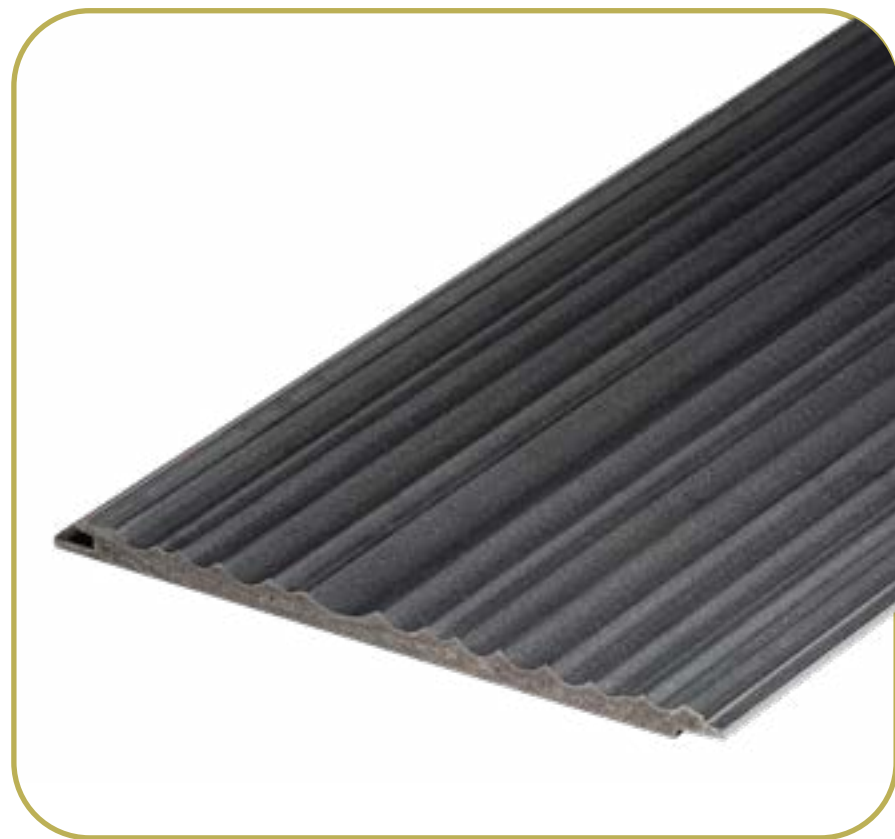

ARKOWOOD M20 IRREGULAR

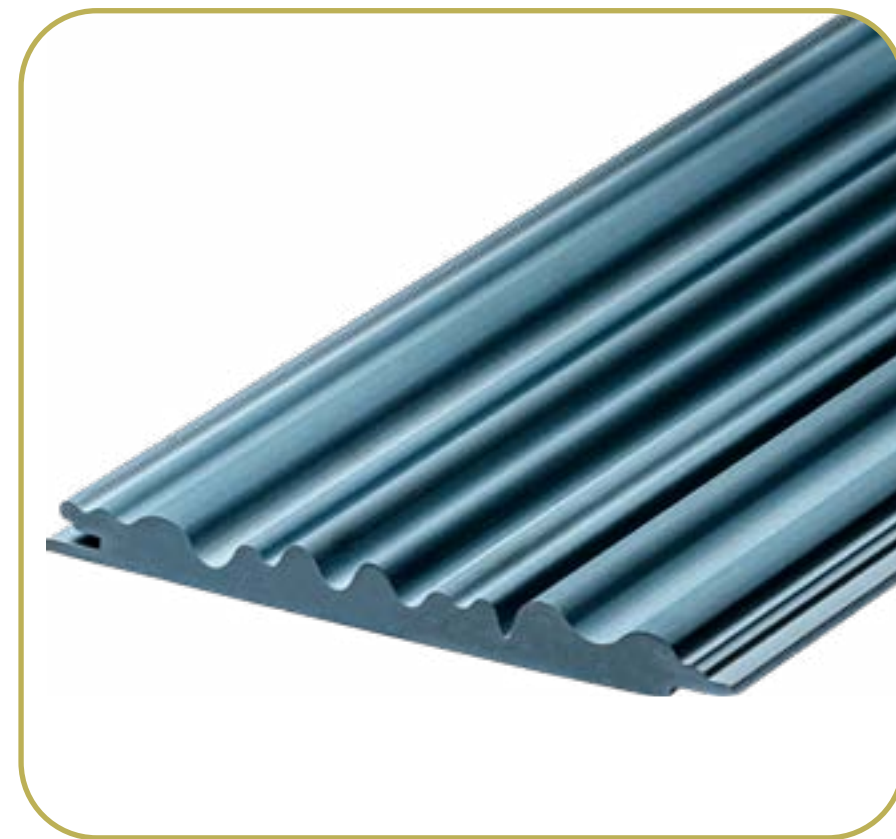

ARKOWOOD MPC













ARKWOOD MP

INSTALAÇÃO

1



Inicie com a instalação dos apoios levando em consideração a distância máxima de 60cm entre apoios para garantir firmeza na instalação.

2

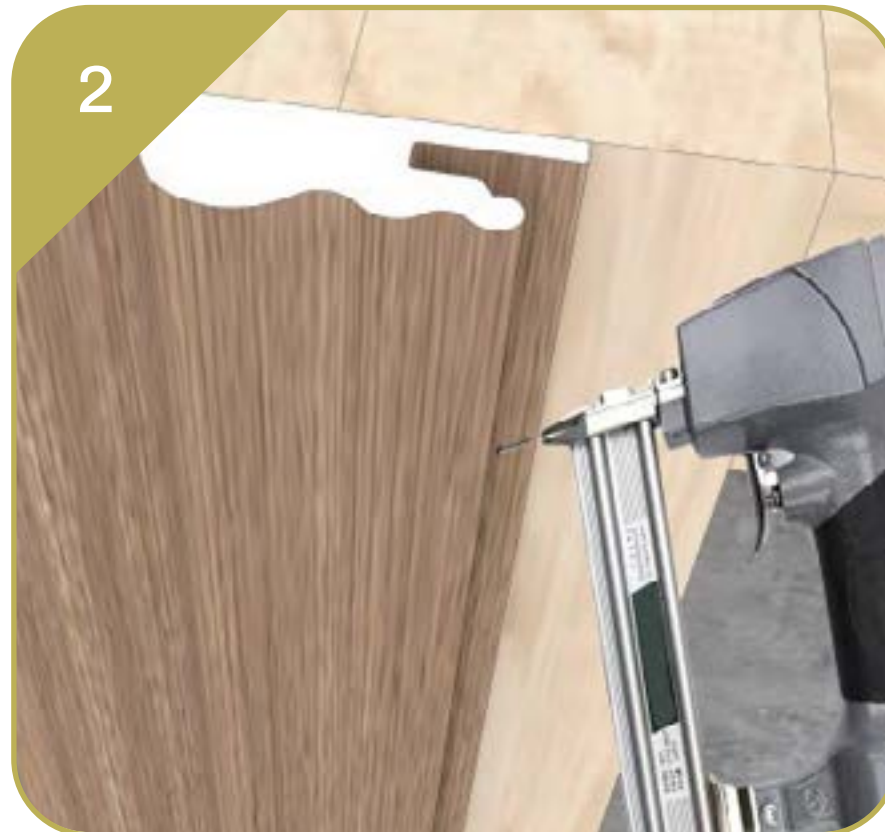

Utilize a pistola de pressão para pregos para fixar os perfis na estrutura de apoios, seguindo a mesma distância para um acabamento perfeito.

(Não inclui elementos acessórios e mão-de-obra)

3



Parafusação de cada régua nos perfis e encaixe das mesmas em sequência, formando o painel ripado.

ARKOWOOD MP

INSTALAÇÃO

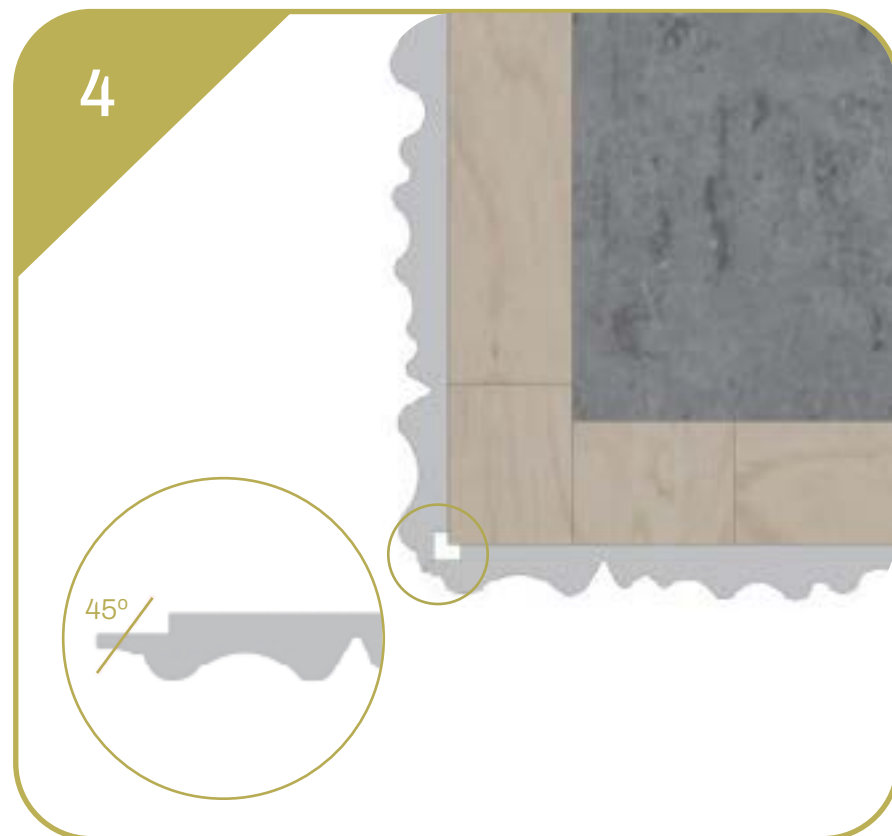

Para o encaixe perfeito nos cantos, realize o corte a 45° e utilize cola para madeira no encaixe das peças, garantindo a fixação.



Ao final da instalação dos perfis, para que o encaixe oculto fique com bom acabamento, é necessário fazer o corte da peça conforme a imagem.

(Não inclui elementos acessórios e mão-de-obra)



Indicamos que, ao final da instalação, utilize um pano limpo e úmido para remover possíveis impurezas.

ARKOWOOD MP

INSTALAÇÃO SOBRE OSB, FIBROCIMENTO, TRIPLAX E DRYWALL

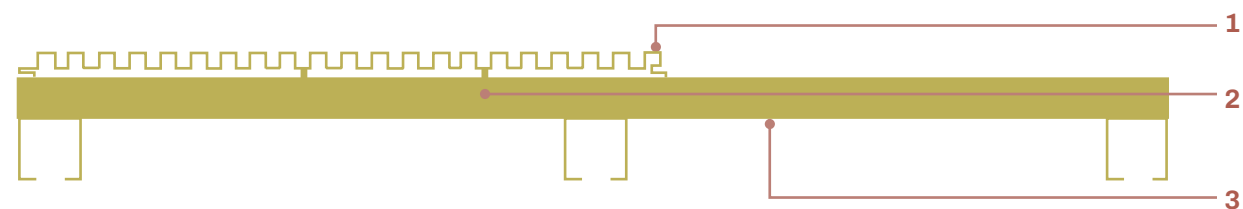

- 1 - Arkowood MP
- 2 - Grampo tipo "F"
- 3 - OSB, Fibrocimento, Triplax ou Drywall



Instalação deve **SEMPRE** começar pela parte "macho" do material.

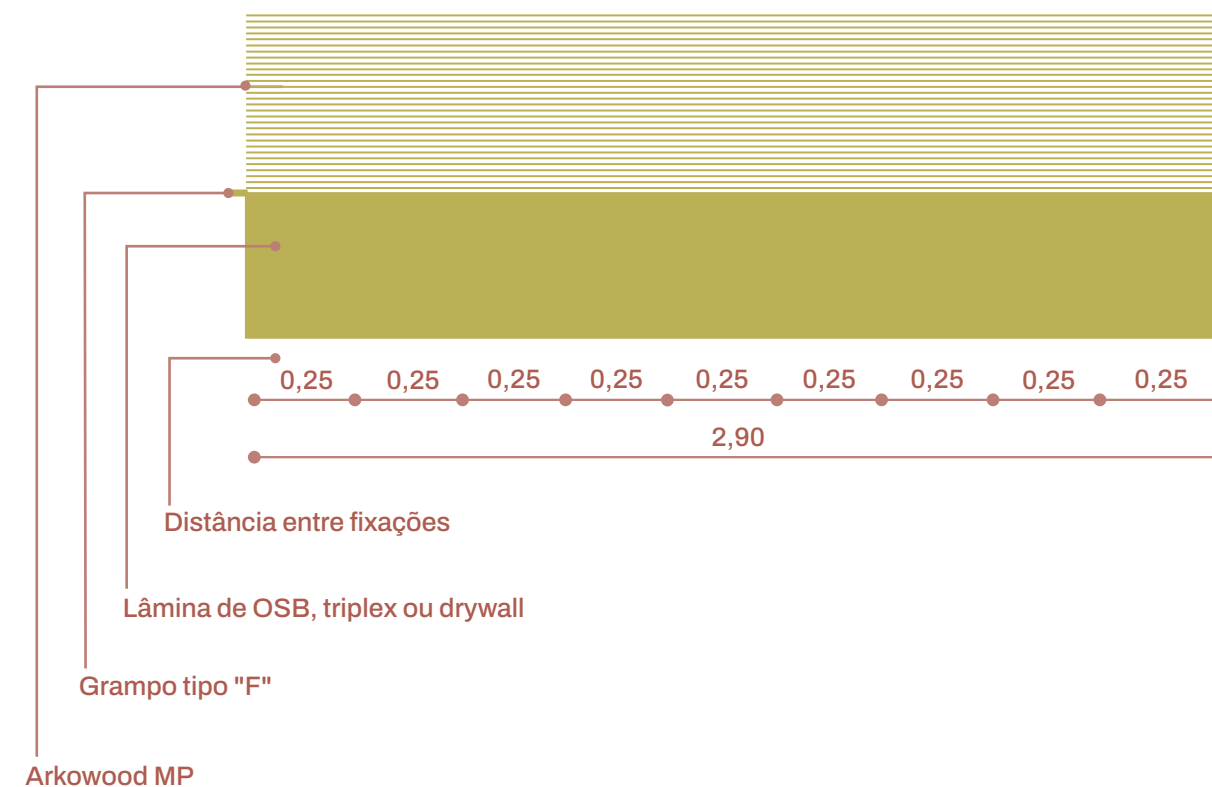

Use uma fita de espuma estrutural de 1"x3 mm ou similar para fixar a peça inicial;
Evite a exposição do grampo.

ARKOWOOD MP

INSTALAÇÃO SOBRE ALVENARIA

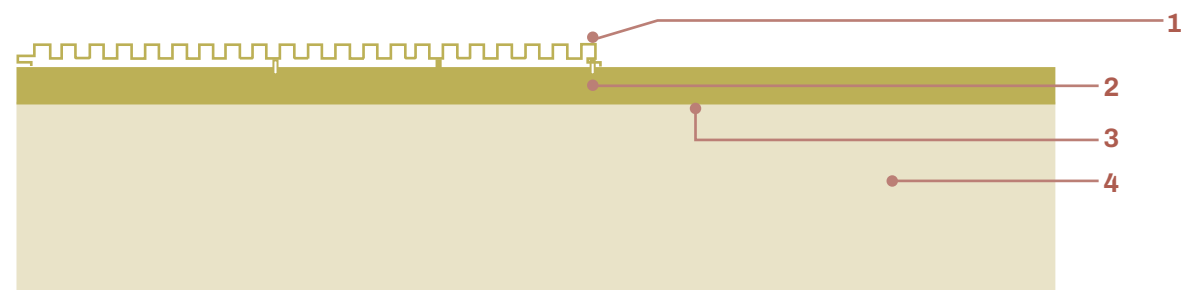

- 1 - Ripado de OSB esp. 09mm x2"
- 2 - Grampo tipo "F"
- 3 - OSB, Fibrocimento, Triplax ou Drywall
- 4 - Alvenaria



Instalação deve SEMPRE começar pela parte do Arkowood P.

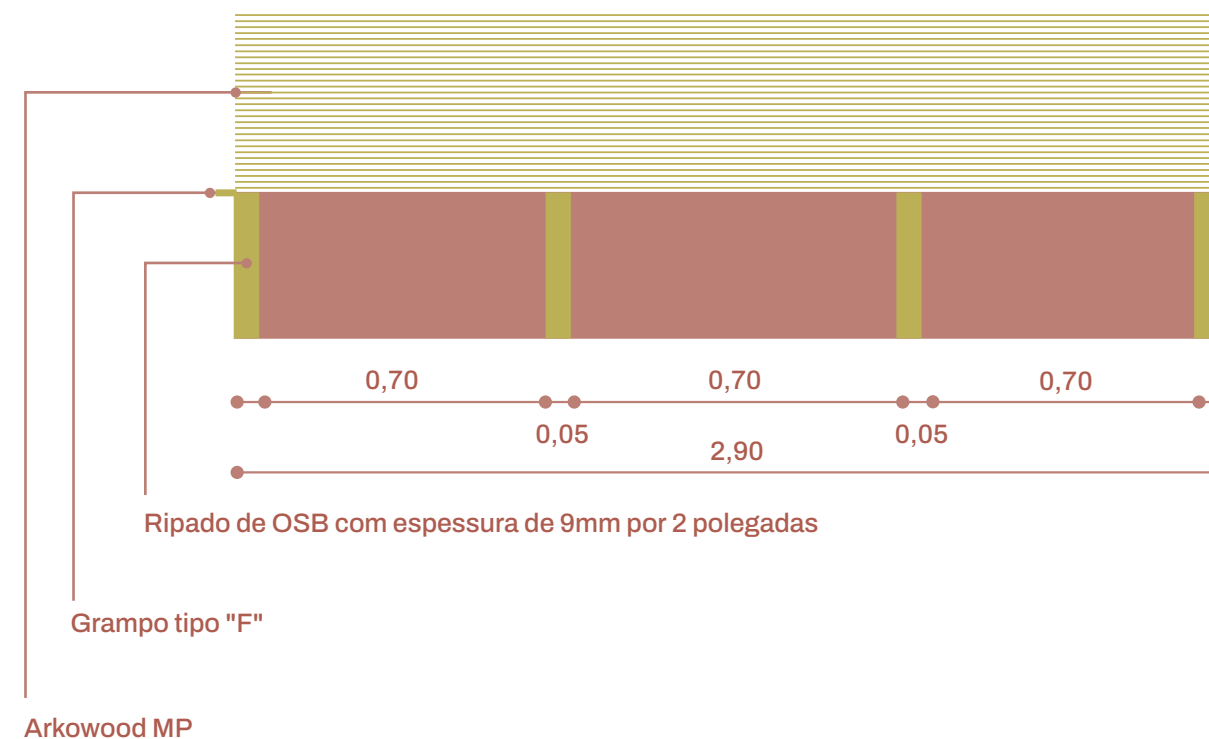

Ripado de OSB com espessura de 9mm por 2 polegadas

Grampo tipo "F"

Arkowood MP

Use uma fita de espuma estrutural de 1"x3 mm ou similar para fixar a peça inicial;
Evite a exposição do grampo.

arkWOOD MP

PAINEL LISO

ARKWOOD MP

SEÇÕES DISPONÍVEIS

ARKWOOD LISO
Metro quadrado a R\$ 420,00

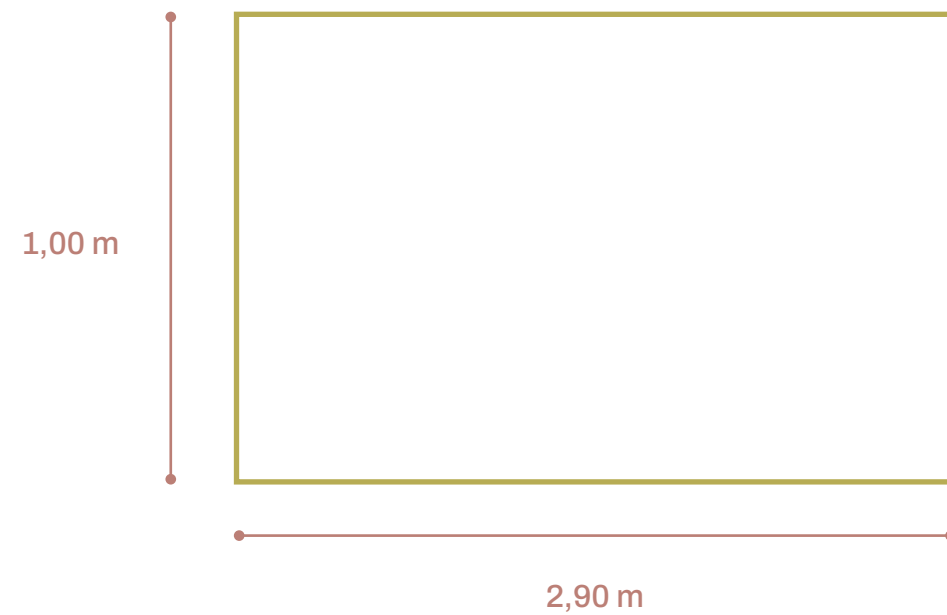

Comprimento de régua: 2,90m x 1,00m





ARKWOOD MP

INSTALAÇÃO

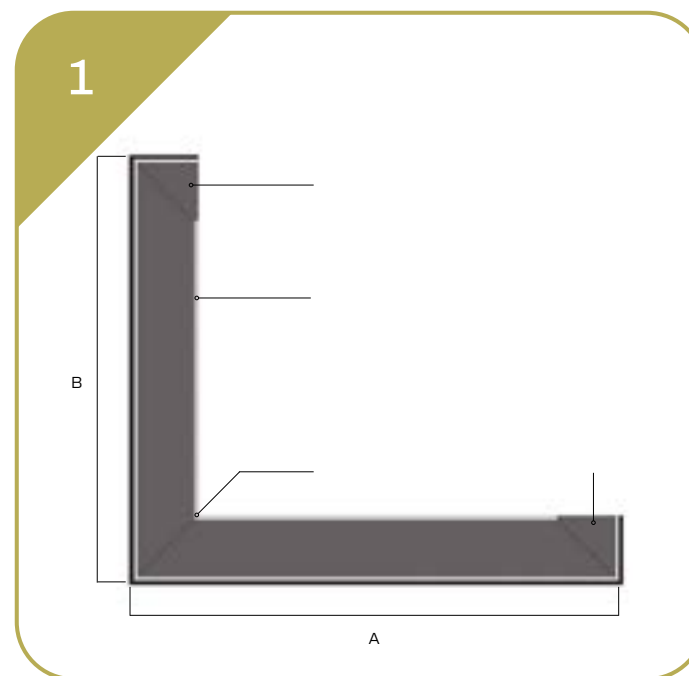
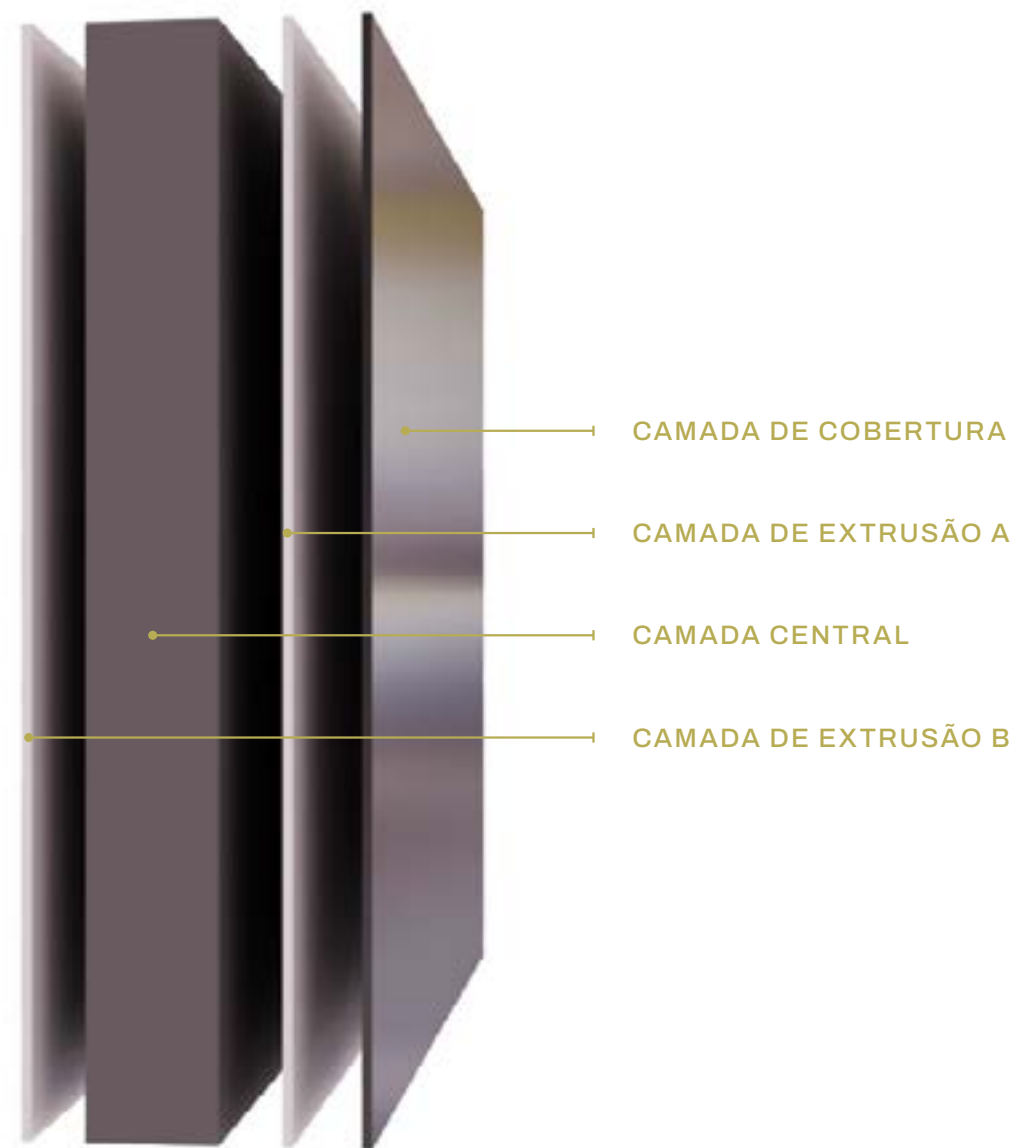

Inicie realizando a medição do espaço e do painel, em seguida realize dobras na borda e ranhuras para que a dobra fique perfeita.



Realize a aplicação do adesivo estrutural na base de madeira para aplicação do painel conforme medidas previamente realizadas.

(Não inclui elementos acessórios e mão-de-obra)

ARKWOOD MP

INSTALAÇÃO

3



Realize a aplicação do painel e mantenha pressionado para garantir que o adesivo se espalhe pela superfície.

4

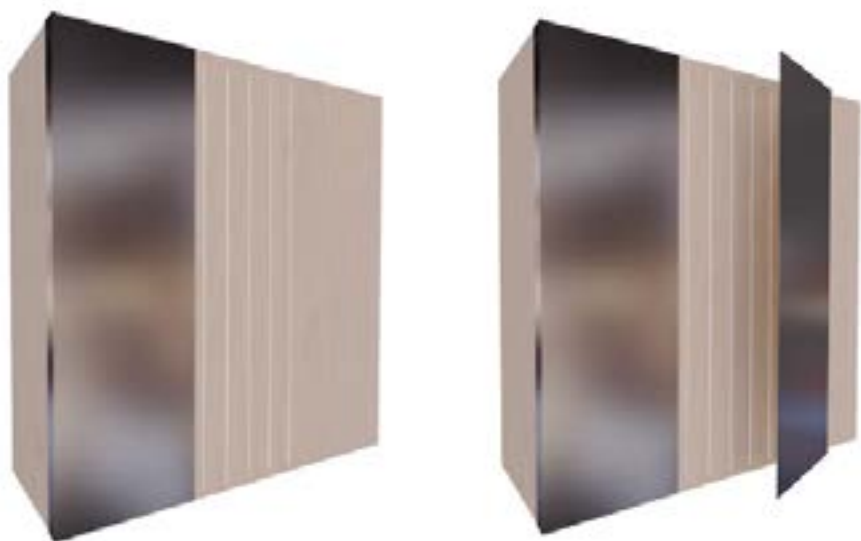

Repita o processo nos demais painéis conforme necessidade, lembrando sempre de pressionar o painel para garantir a aplicação correta.

5



É necessário um espaçamento de 2mm a 5mm pois o material pode sofrer dilatação.

(Não inclui elementos acessórios e mão-de-obra)

ARKOWOOD MP

RECOMENDAÇÕES DE USO E MANUTENÇÃO

Não bata no material durante a descarga e segure-o muito bem durante o transporte, armazene o produto em paletes ou bases firmes, uniformes e rígidas, não exceda 40 unidades na vertical ao empilhar e não descanse elementos pesados sobre o produto armazenado.

Proteja-o dos elementos com materiais não translúcidos: polietileno preto, papelão ou materiais similares, garantindo fluxo contínuo de ar. Se houver contaminação, limpe imediatamente removendo qualquer substância derramada, não utilize produtos abrasivos e não esfregue, molhe-o com água quente e seque com um pano macio. Pode ser lavado à pressão, com uma recomendação de pressão máxima de 1100 PSI, sempre adote as medidas de segurança necessárias e evite danos ao material.

AMANTES DE BOA ARQUITETURA

arkos

www.arkosbrasil.com.br

 arkosbrasil



 +5511971196692