

arkos

# arkowood K

---

BRISES RIPADOS DE MADEIRA ECOLÓGICA  
PARA EXTERIORES E INTERIORES







## Características

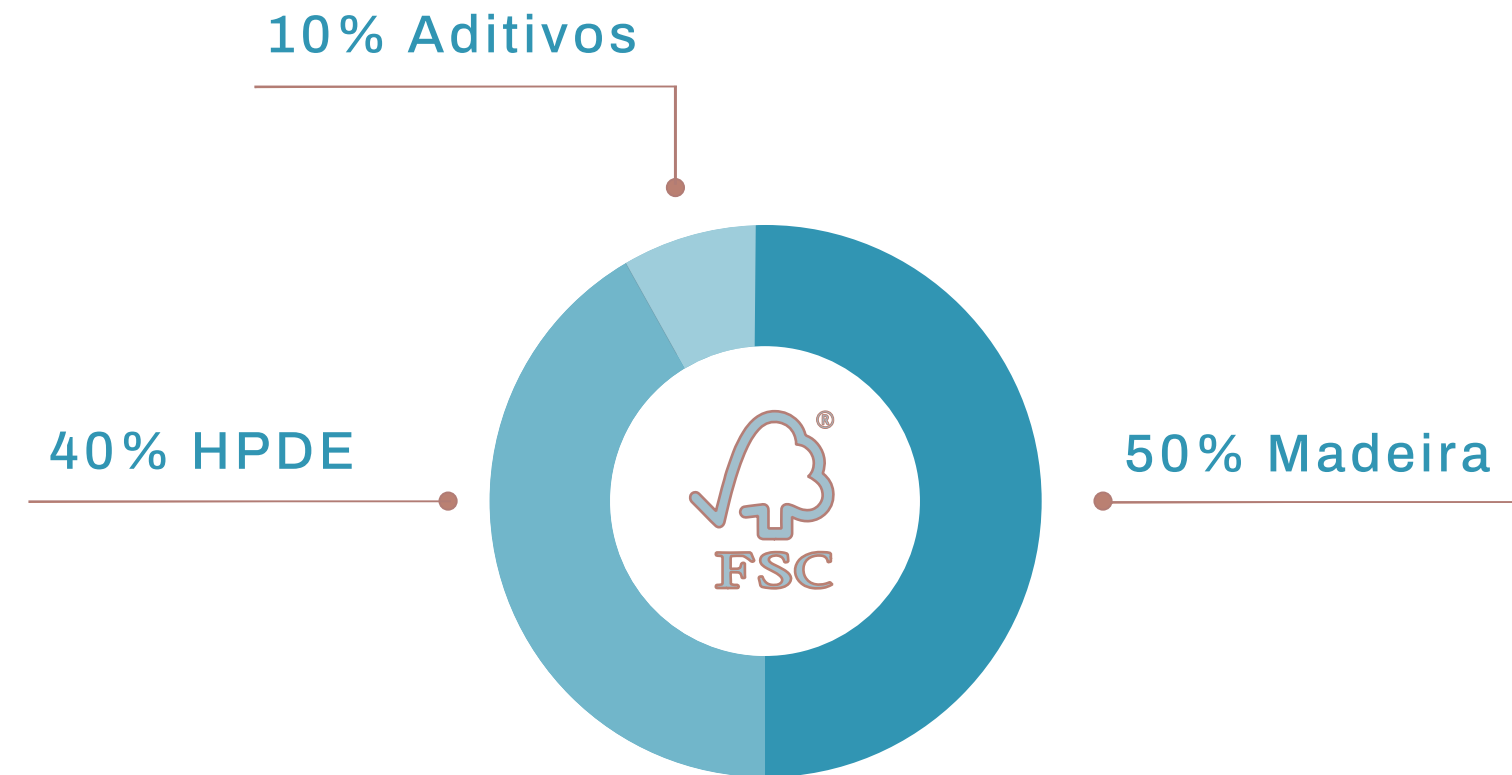

Brises e ripados compostos de madeira ecológica, HDPE e aditivos, certificado pelo selo FSC de responsabilidade ambiental, desenhados para aplicação em áreas externas graças à tecnologia de proteção UV, que garante a estabilidade cromática do produto durante toda a sua vida útil.





## Características

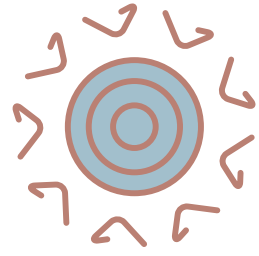

Proteção UV

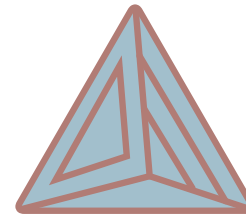

50% Madeira  
40% PVC de alta densidade  
10% Aditivos

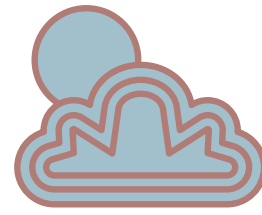

Aplicável em todo tipo  
de clima

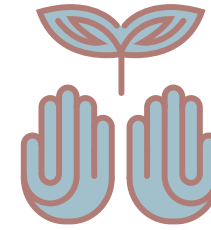

Responsabilidade com o  
meio-ambiente

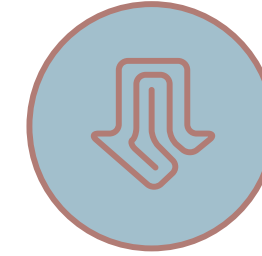

Fácil instalação

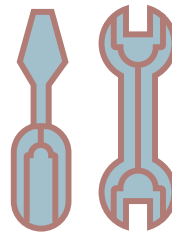

Não requer manutenção

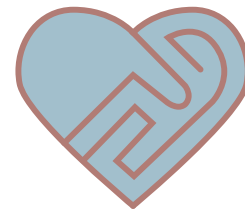

Vida útil de mais de 20 anos



Garantia de 10 anos



Certificado por FSC



## Seções disponíveis

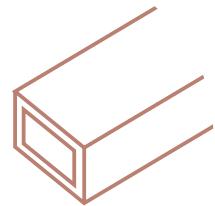

**50 x 30**  
R\$41/metro linear  
*1,15 kg/ML*

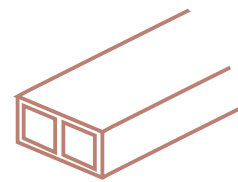

**60 x 30**  
R\$54/metro linear  
*1,40 kg/ML*

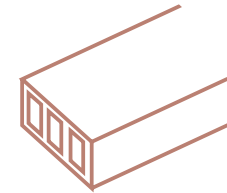

**60 x 40**  
R\$58/metro linear  
*1,55 kg/ML*

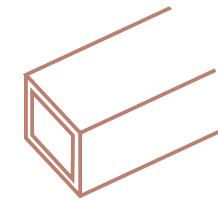

**55 x 55**  
R\$61/metro linear  
*1,45 kg/ML*

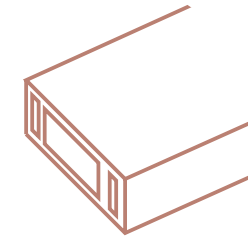

**100 x 30**  
R\$65/metro linear  
*1,65 kg/ML*

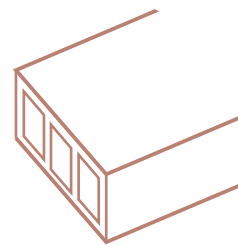

**100 x 50**  
R\$76/metro linear  
*2,17 kg/ML*

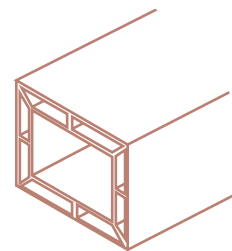

**145 x 145**  
R\$357/metro linear  
*3,80 kg/ML*

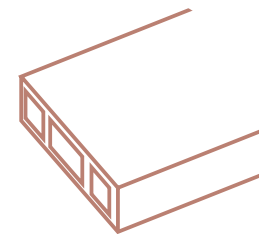

**150 x 50**  
R\$158/metro linear  
*3,80 kg/ML*

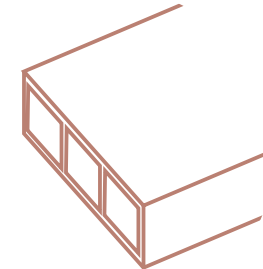

**180 x 80**  
R\$175/metro linear  
*4,00 kg/ML*

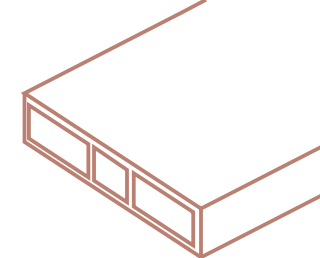

**200 x 60**  
R\$180/metro linear  
*4,65 kg/ML*

Tampa (und.): R\$3,30 (0,05kg/und)

**Comprimento de régua: de 2,80m até 5,60m**

# ARKWOOD K

## PALETA DE CORES



areia



cedro



cinza



preto



nogal



teka



café

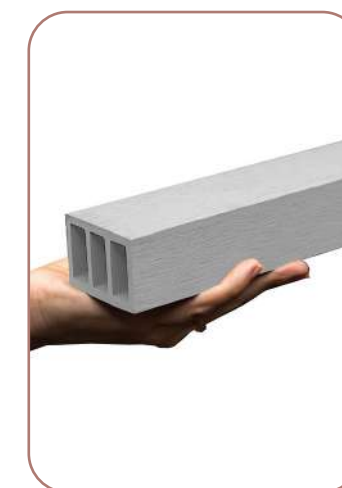

white grey

A escolha da cor não altera o preço final

ARKOS



ARKWOOD K

PALETA DE CORES (TEXTURAS)



areia



cedro



cinza



preto



nogal



teka



café

A escolha da cor não altera o preço final

ARKOS

arkWOOD K

---

PROJETOS RESIDENCIAIS





**Casa Lagos Park - Brazil Arquitetos**

ARKWOOD K 50X30 CEDRO

Xangri-lá, RS, Brasil









**Casa Alphaville**  
ARKWOOD K 50x30 AREIA  
Barueri, São Paulo









**Casa BH - Manulolato Arquitetura**

ARKOWOOD K 50X30 PRETO

Nova Lima, Minas Gerais









**Casa RMD - Jacobsen Arquitetura**

ARKWOOD K 50X30 CINZA

Bragança Paulista, São Paulo

















Casa Aldeia da Serra  
Gabriela Toledo Arquitetura  
Aldeia da Serra, SP







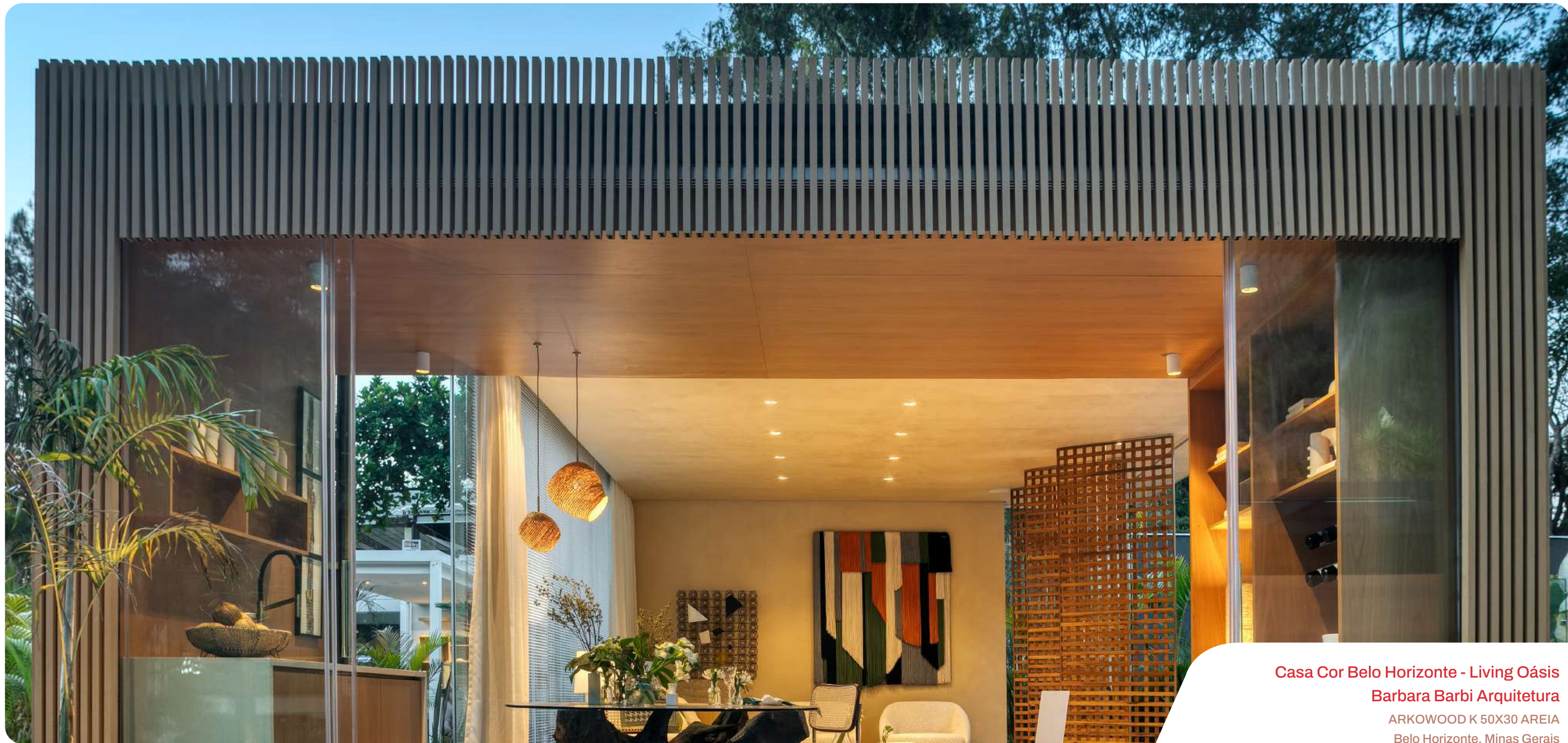

Casa Cor Belo Horizonte - Living Oásis

Barbara Barbi Arquitetura

ARKWOOD K 50X30 AREIA

Belo Horizonte, Minas Gerais









**Casa Árvore - Boechat Casas + Catalise Arquitetura**  
ARKWOOD K 50X30 CEDRO E NOGAL  
Nova Lima, Belo Horizonte, Minas Gerais



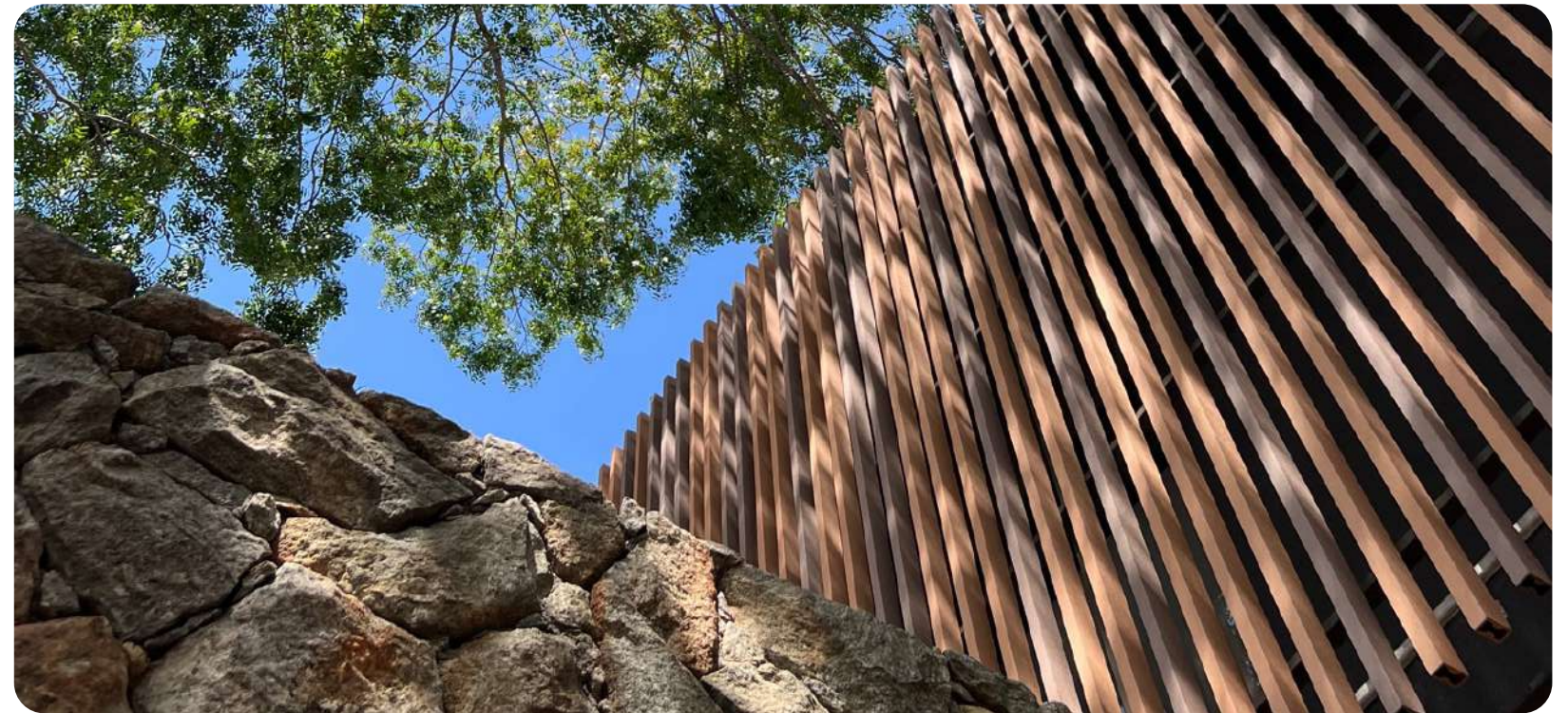
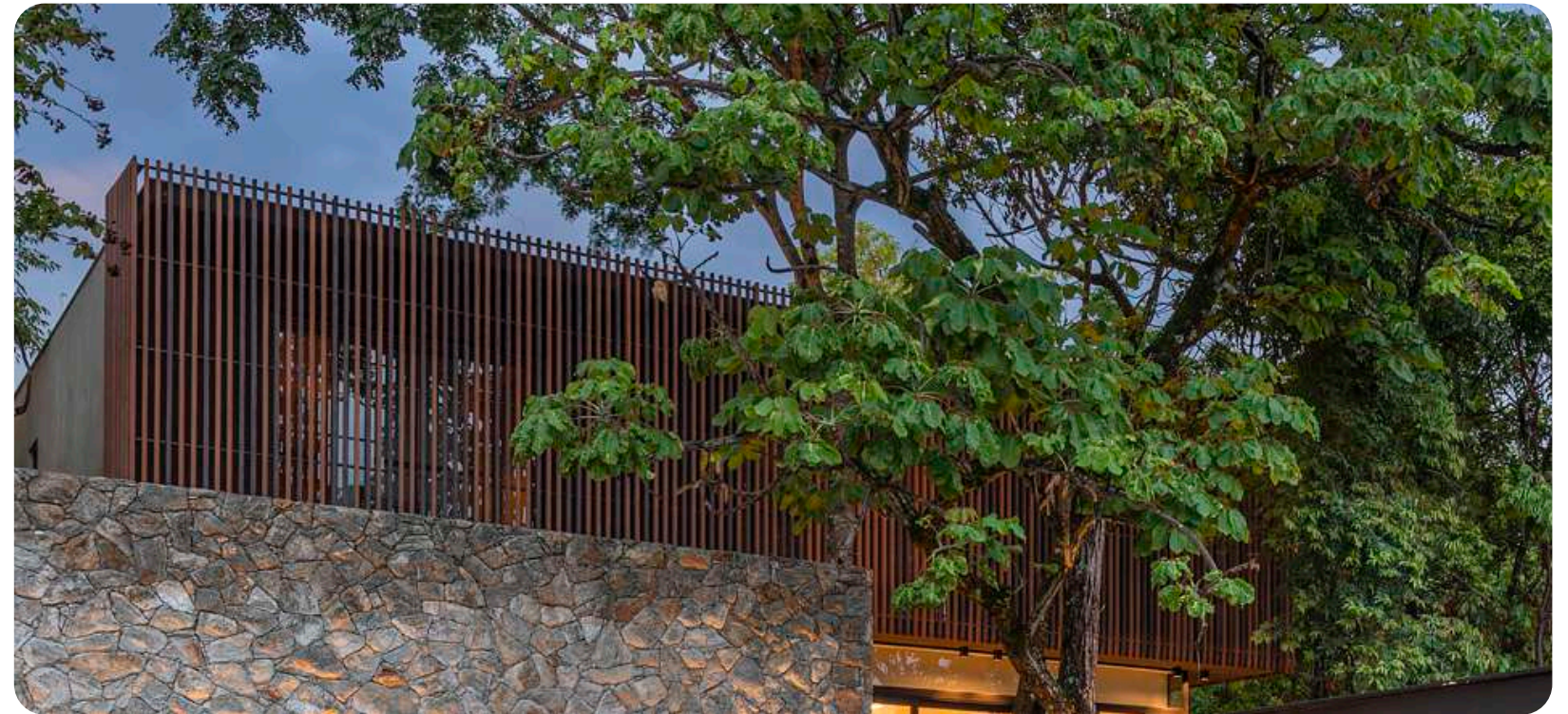





**Casa Baronesa**  
**Felipe Caboclo Arquitetura**  
ARKWOOD K 50X30 CINZA  
Quinta da Baronesa, SP



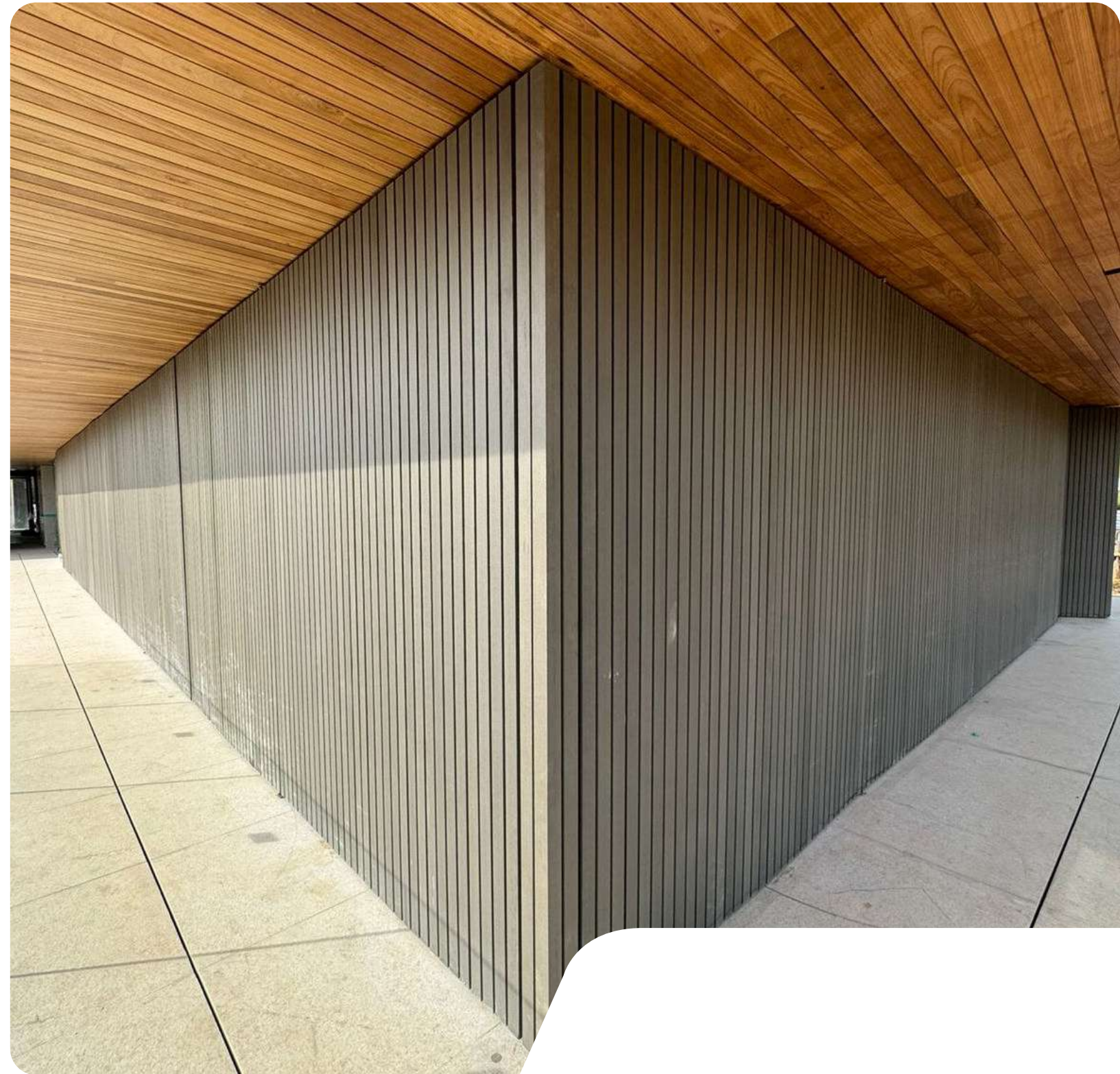



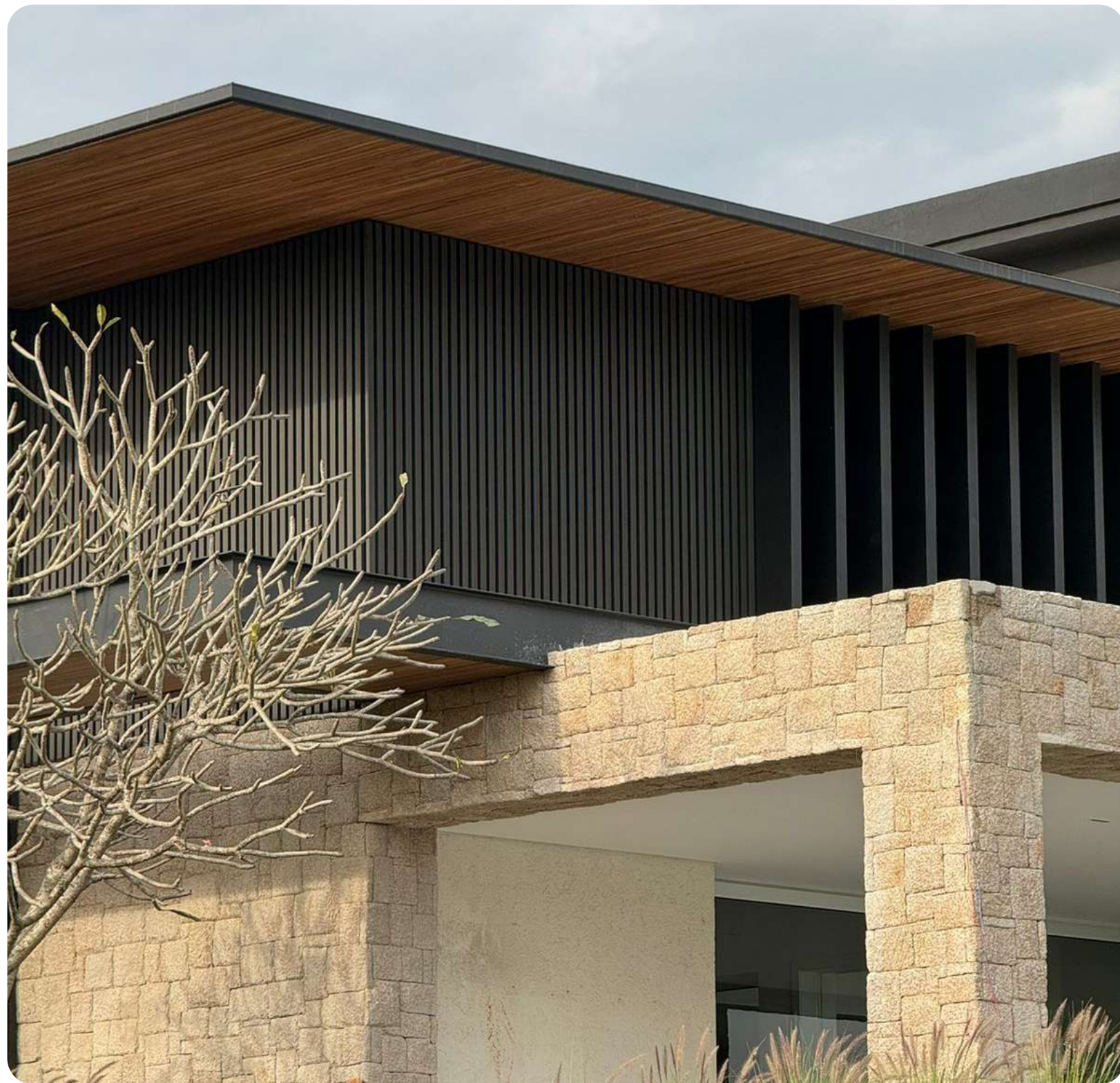

**Casa Baronesa 2**  
**Felipe Caboclo Arquitetura**  
ARKWOOD K 50X30 PRETO  
Quinta da Baronesa, SP









**Casa Prática - Studio Zargos**  
ARKOWOOD K 50X30 TEKA E NOGAL  
Belo Horizonte, Minas Gerais



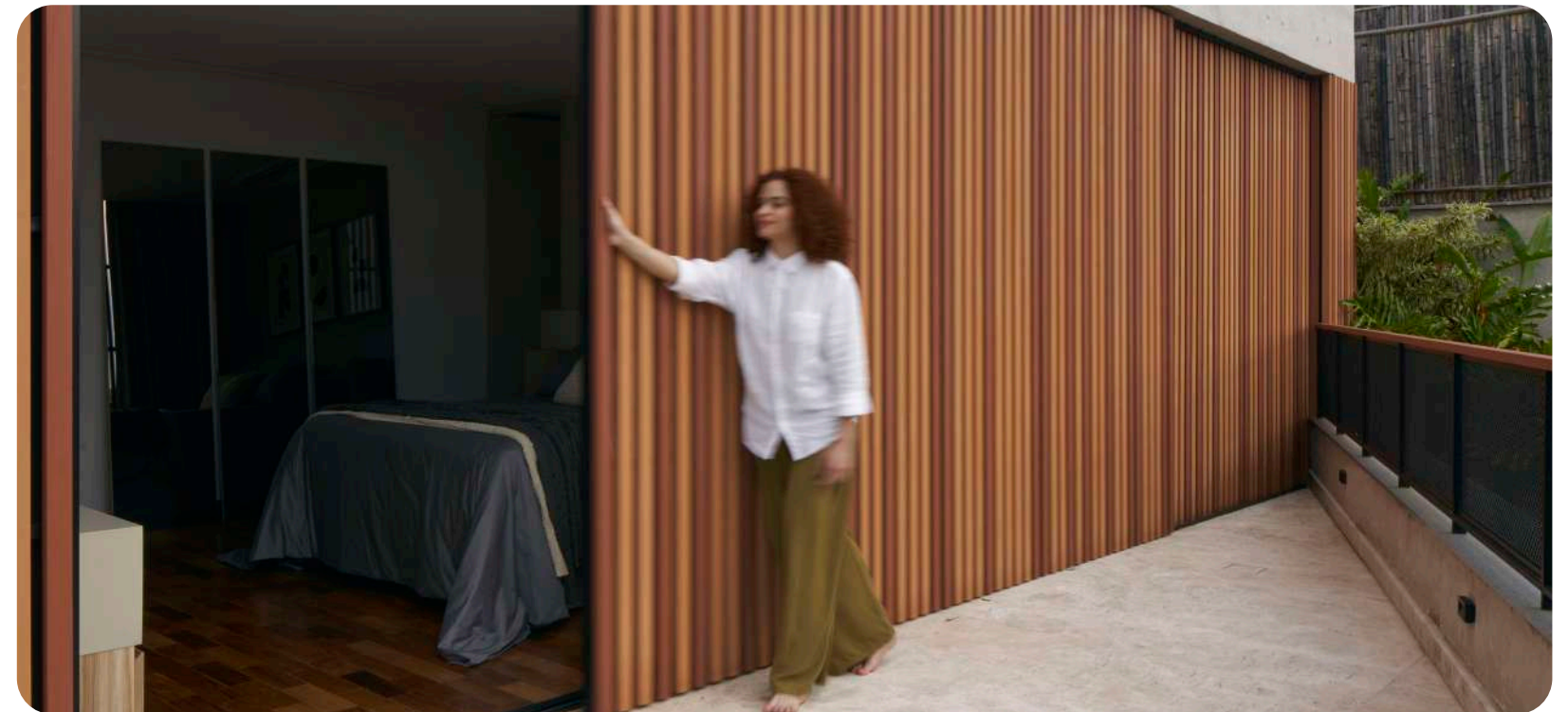





Casa SF

Gabriel Micherif Arquitetura

ARKWOOD K 50X30 CEDRO E NOGAL

Alphaville, Juiz de Fora, MG













**Casa AJ - Zappacon Engenharia**

ARKOWOOD K 50X30 PRETO

Bragança Paulista, São Paulo



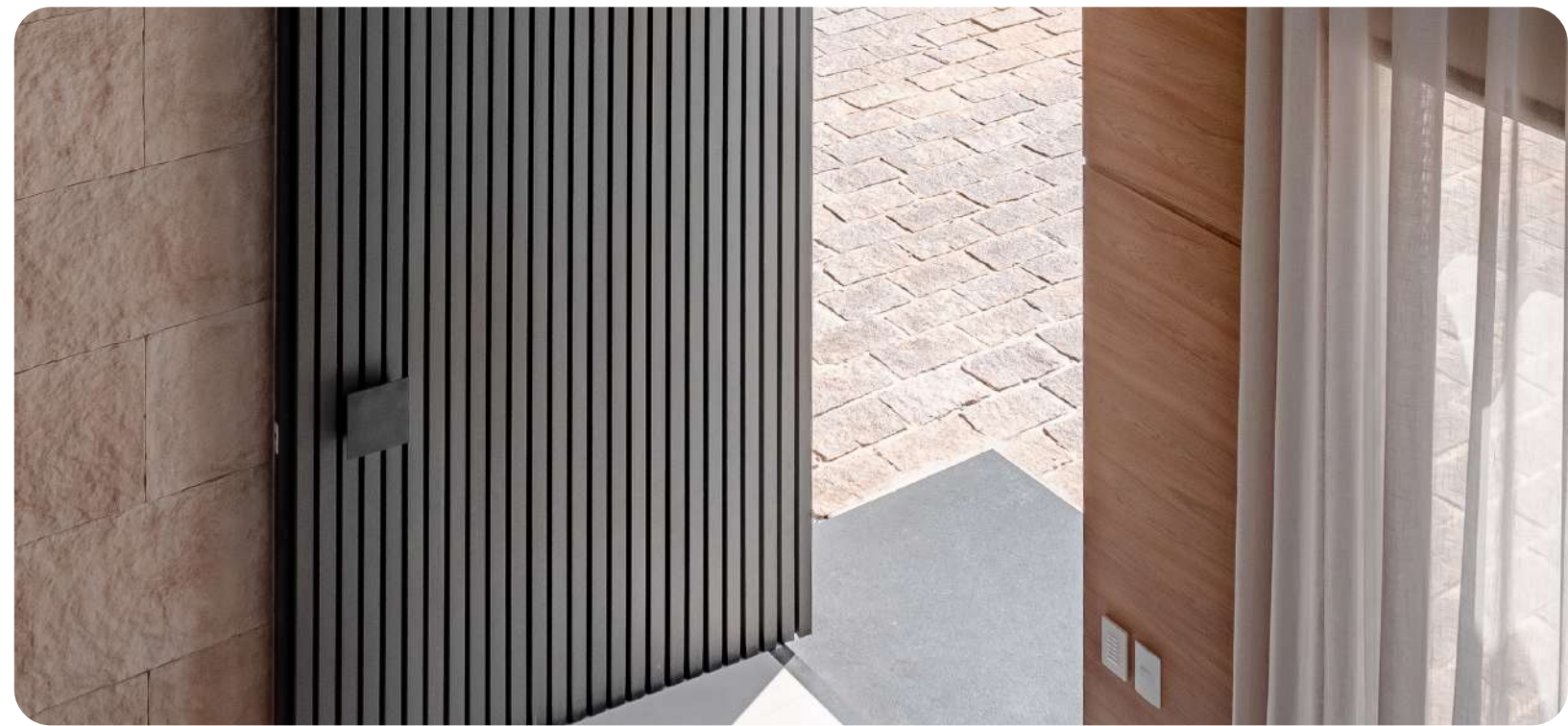
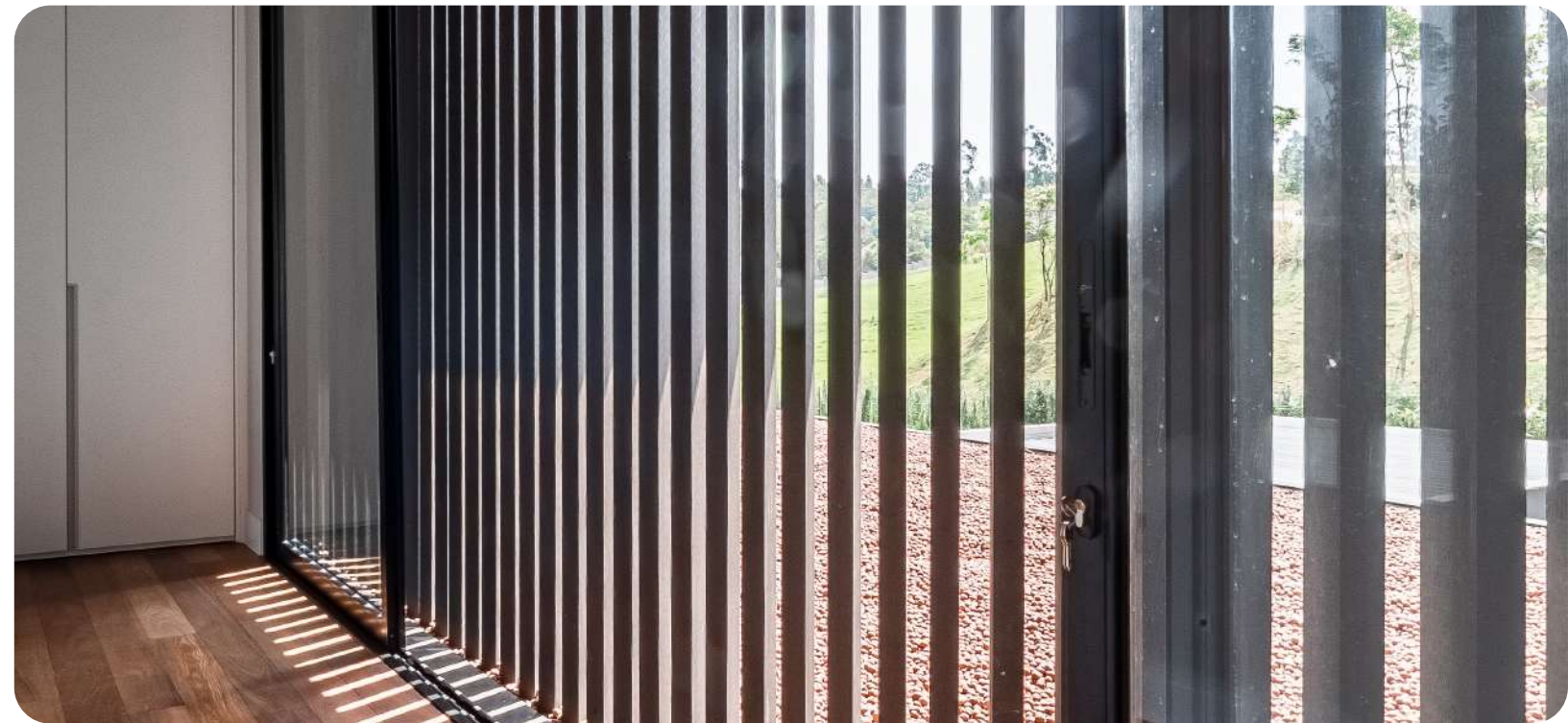



arkWOOD K

---

PROJETOS INSTITUCIONAIS



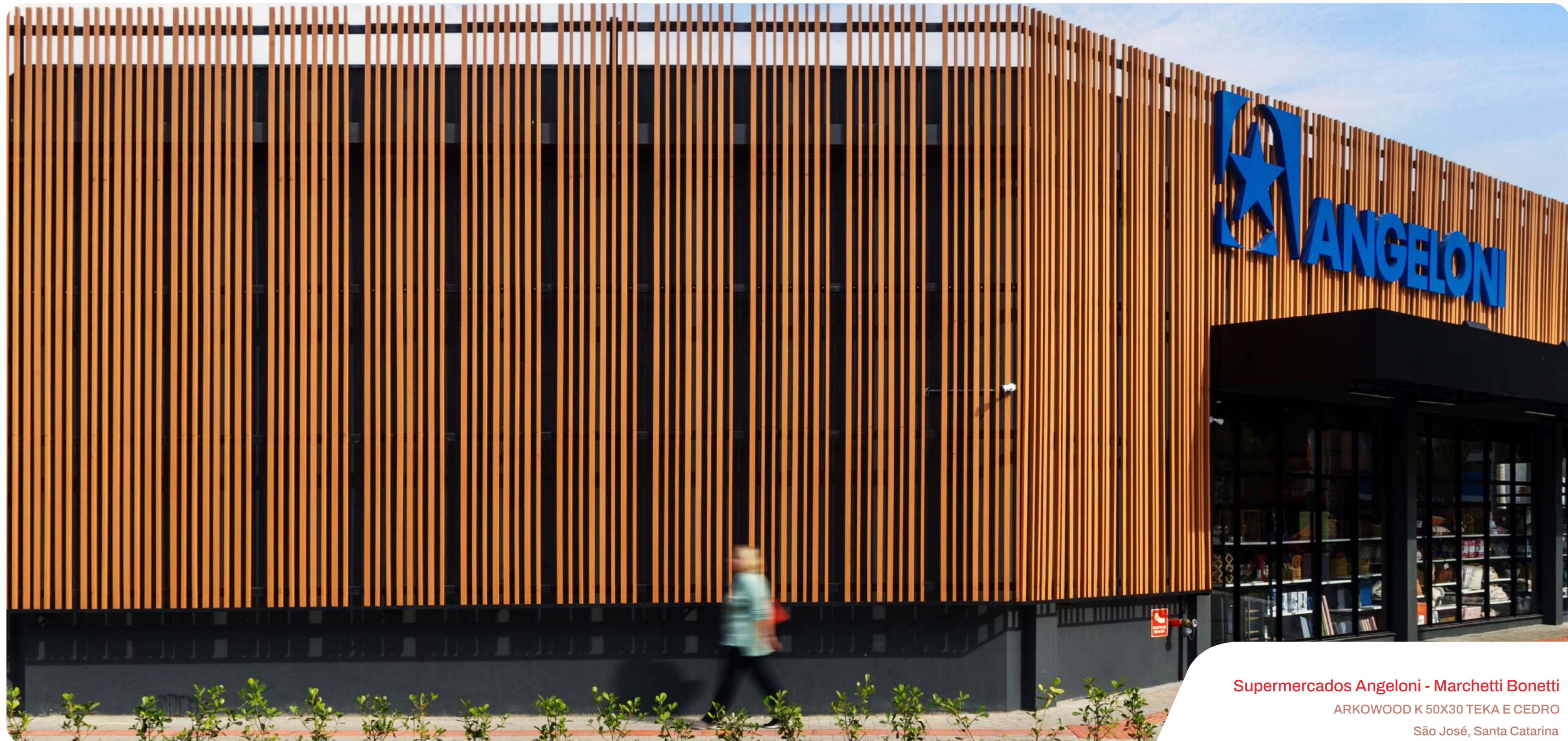

**Supermercados Angeloni - Marchetti Bonetti**

ARKWOOD K 50X30 TEKA E CEDRO

São José, Santa Catarina



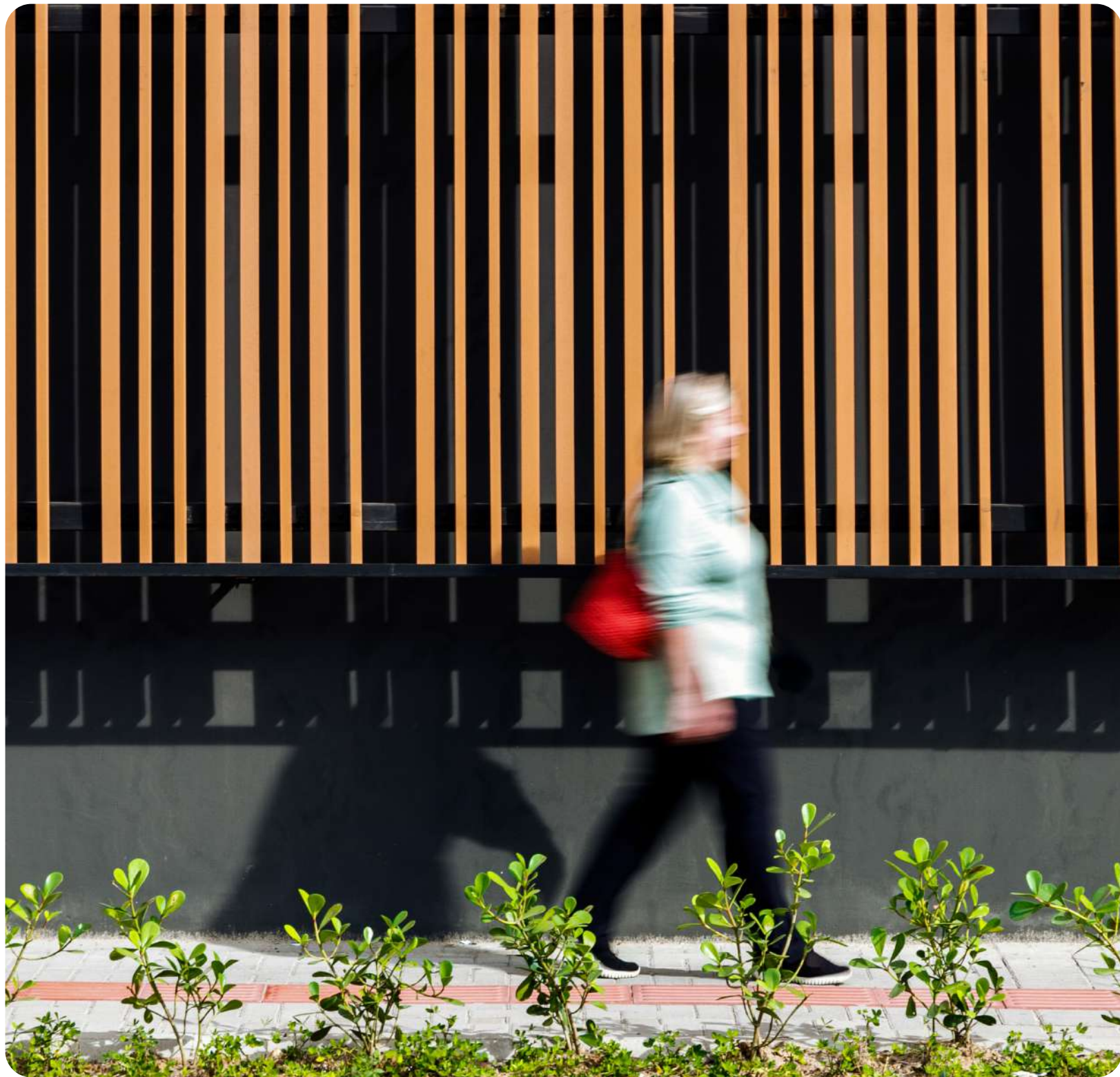





FACULDADE  
**CATÓLICA RO**

*A Universidade do futuro, hoje*

Faculdade Católica de Porto Velho  
Barros Arquitetura  
Porto Velho, RO





FACULDADE  
CATÓLICA RO

















**Red House School - Studio Dlux**  
ARKWOOD K 50X30 AREIA + 100X30 AREIA

Santo André, São Paulo



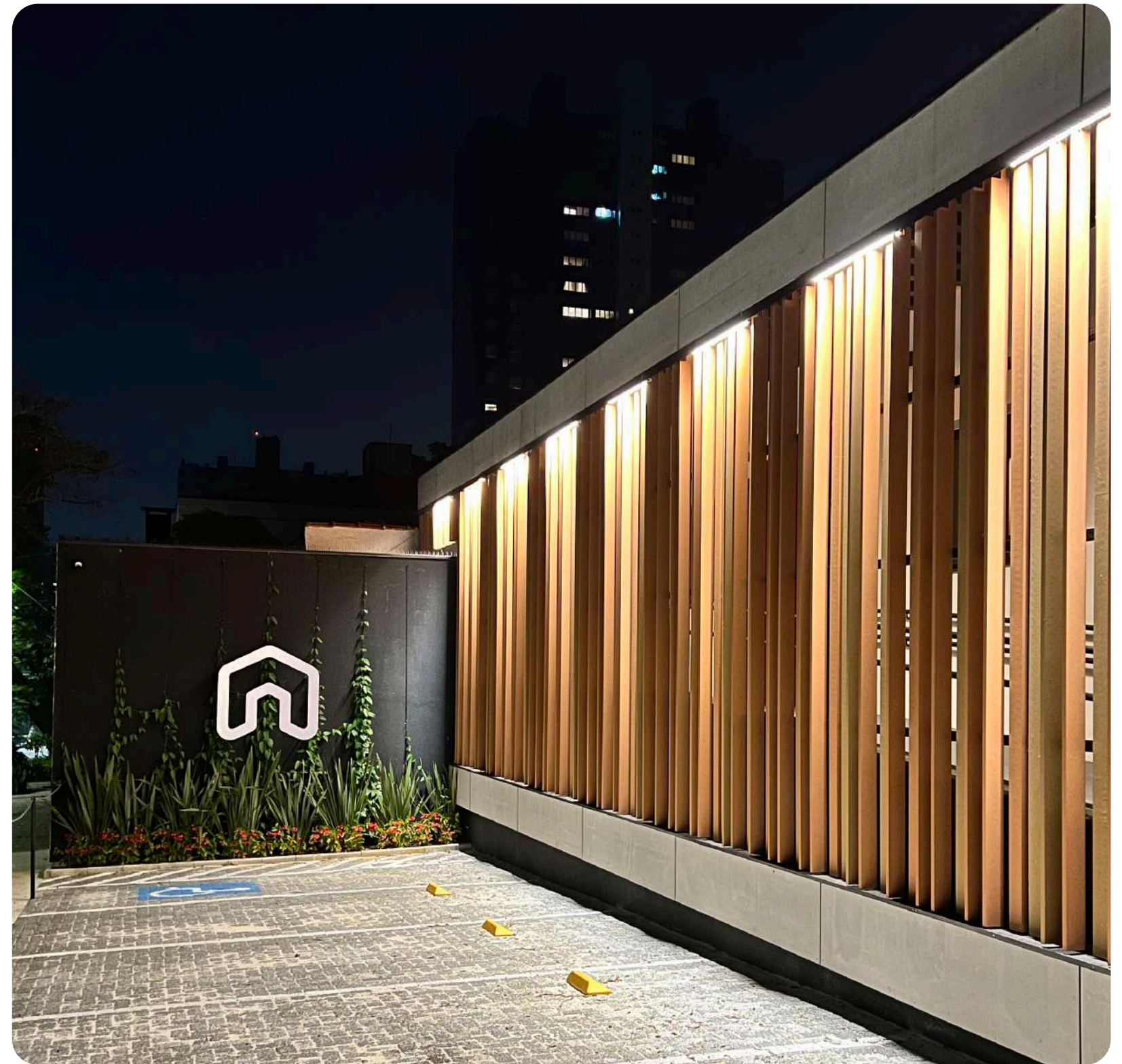
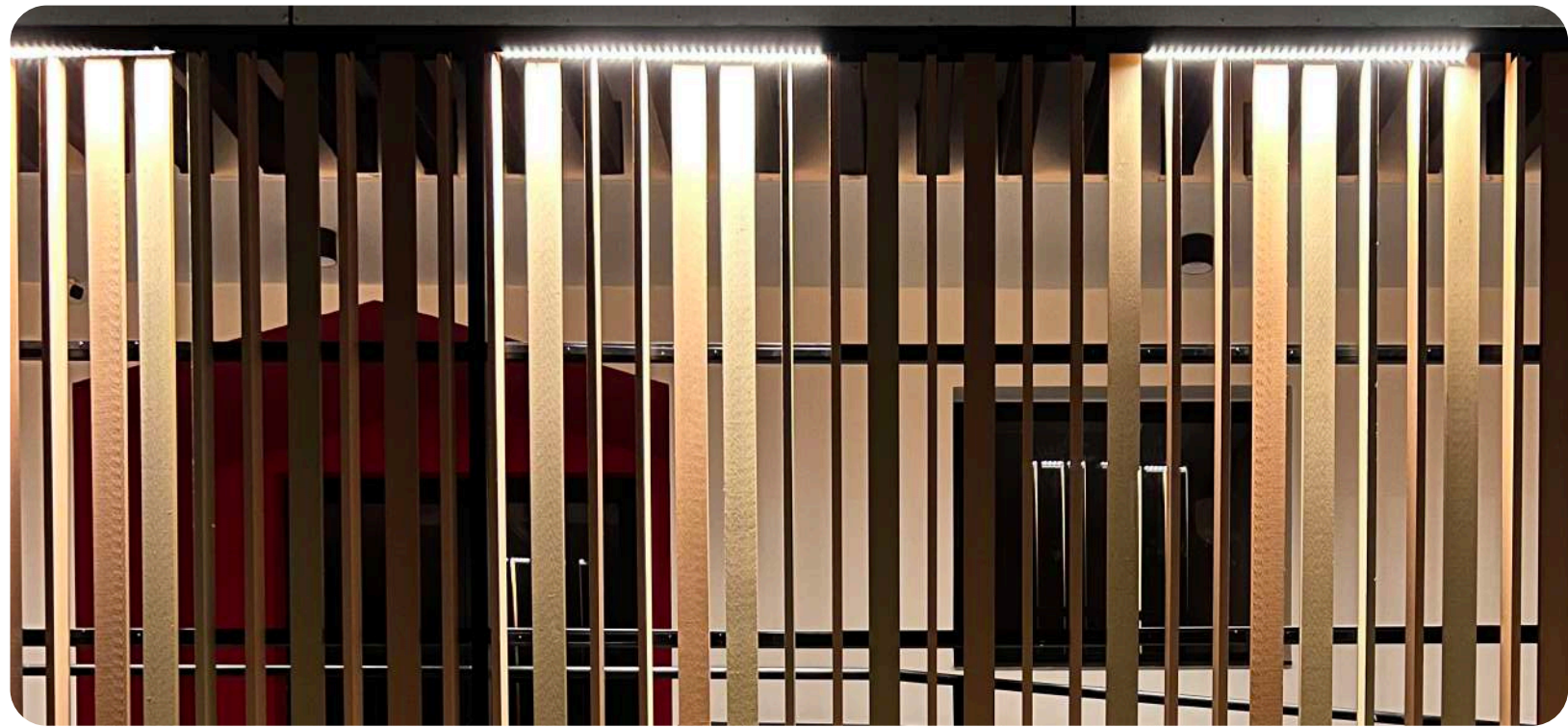





**Colégio Pies Descalzos - El Equipo Mazzanti**

ARKWOOD K 60X30 NOGAL

Barranquilla, Colômbia



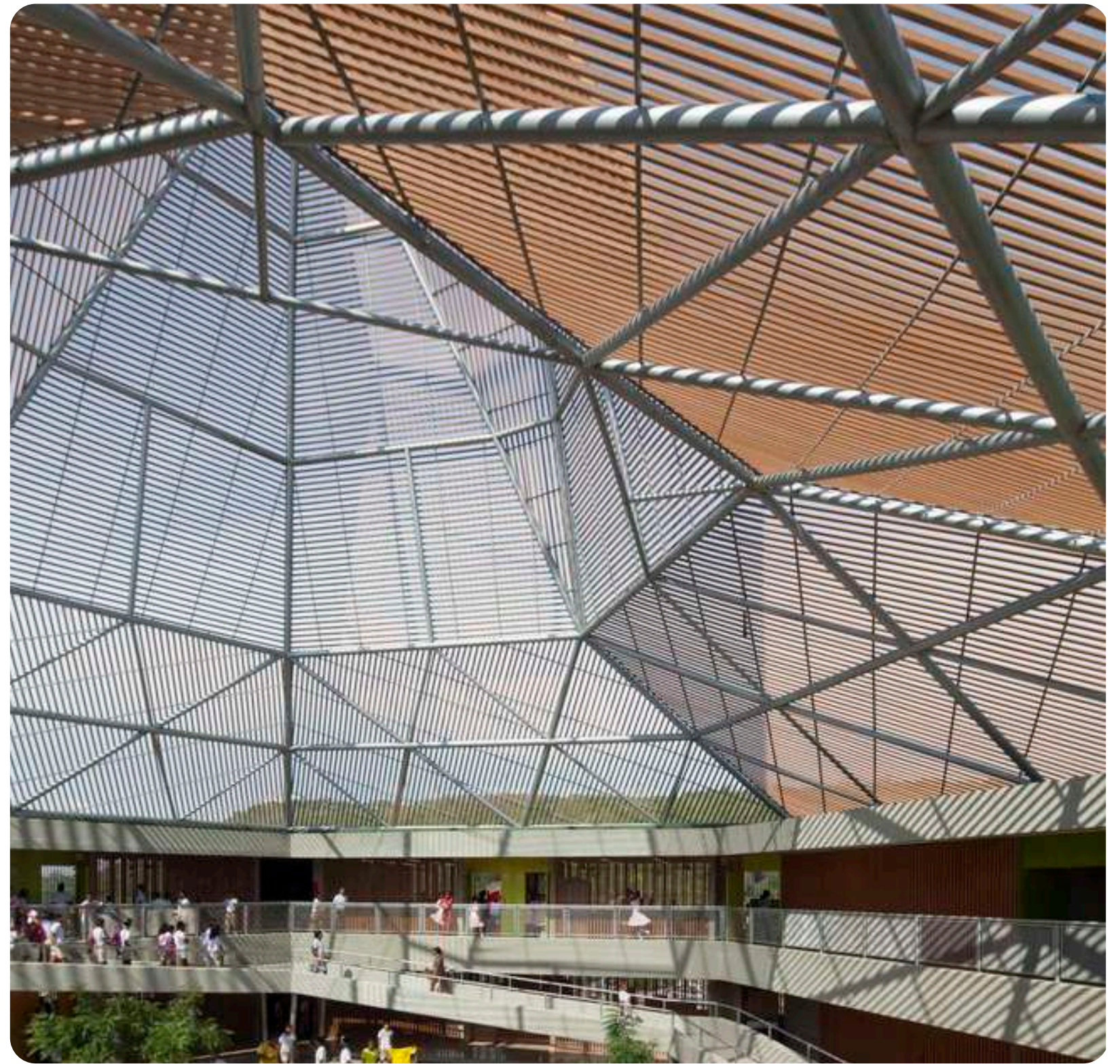
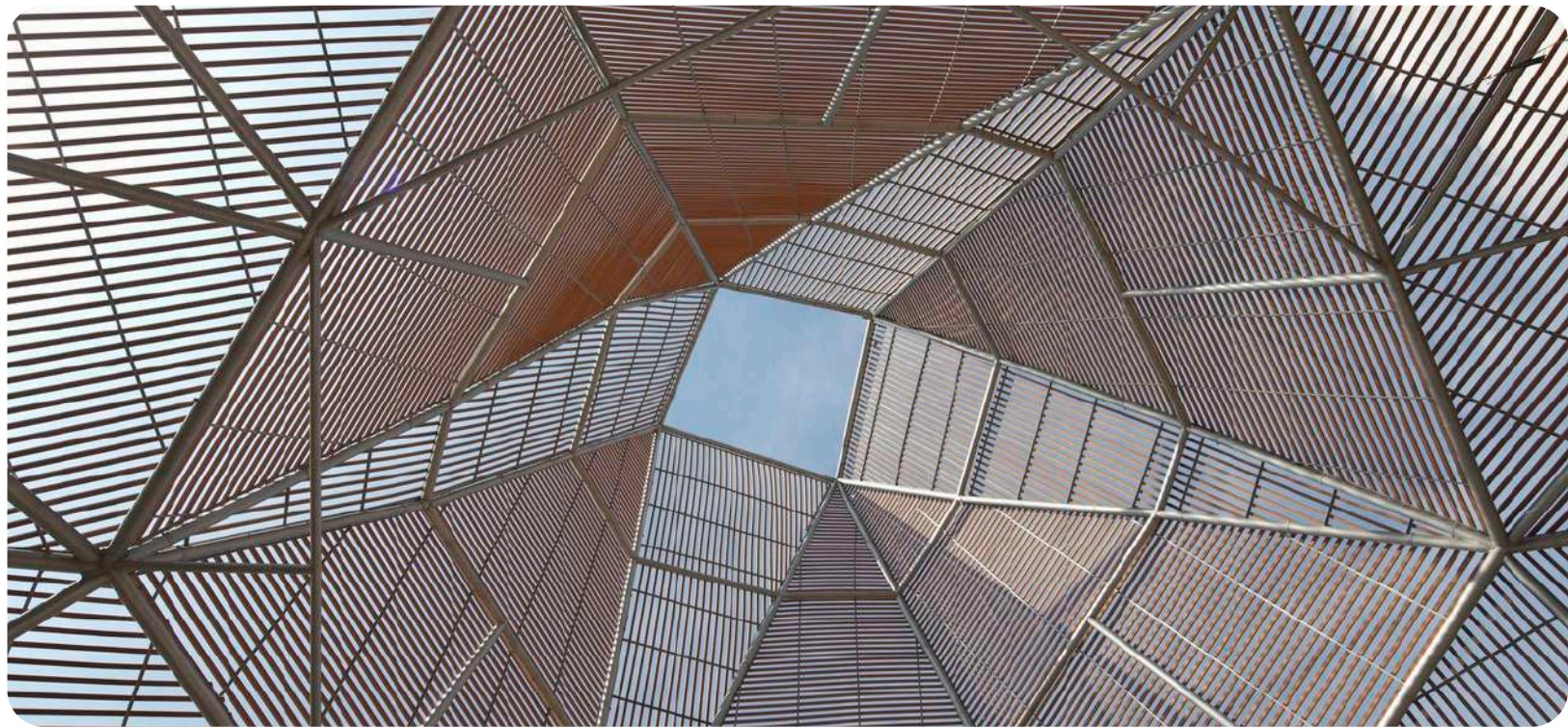





**Escritórios EDP São Paulo - IT'S Informov**

ARKWOOD K 60X30 CEDRO

São Paulo, SP







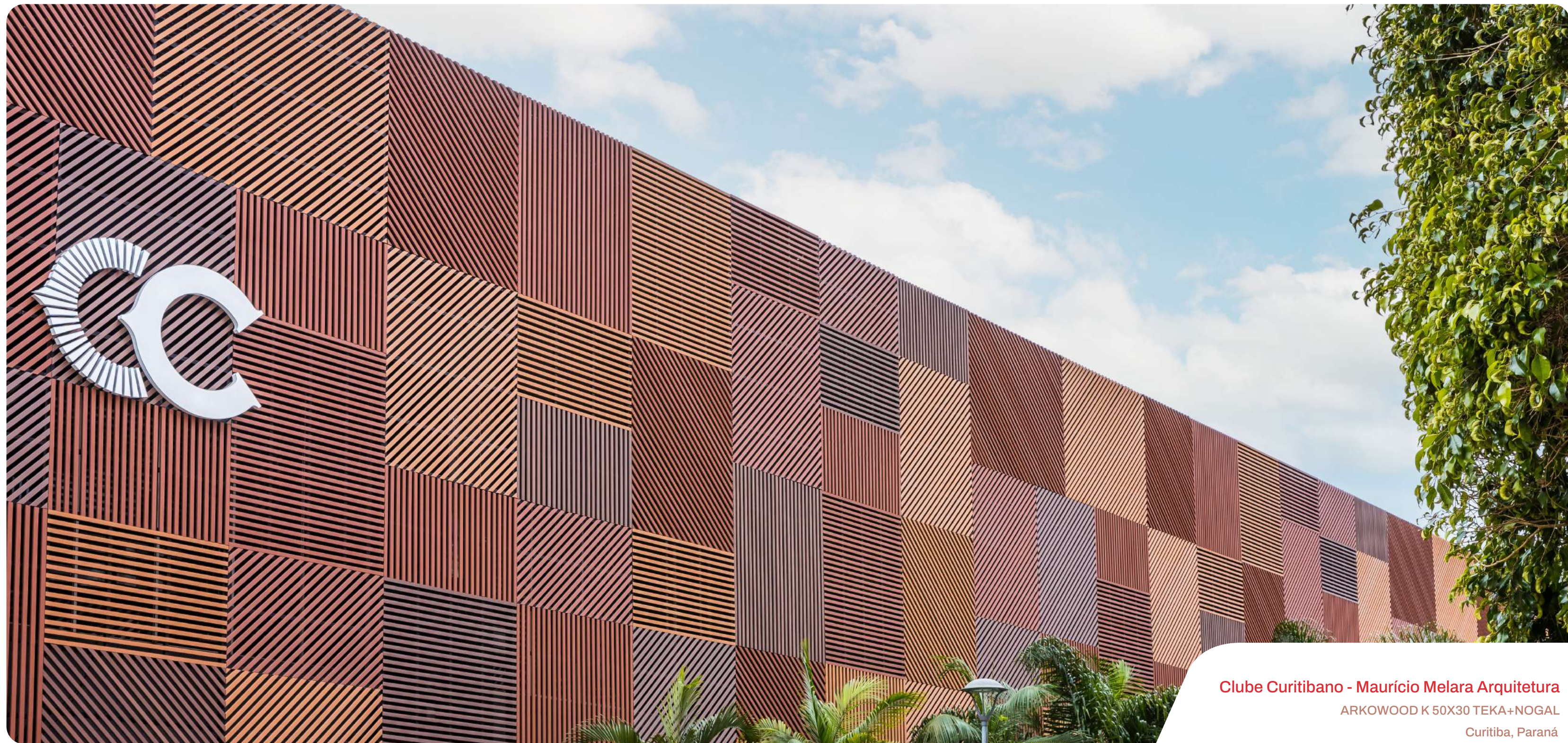

**Clube Curitibano - Maurício Melara Arquitetura**

ARKOWOOD K 50X30 TEKA+NOGAL

Curitiba, Paraná









**Colégio Pueri Domus - Perkins&Will**  
ARKWOOD K 60X40 TEKA+NOGAL, 150x50 PRETO  
São Paulo, SP



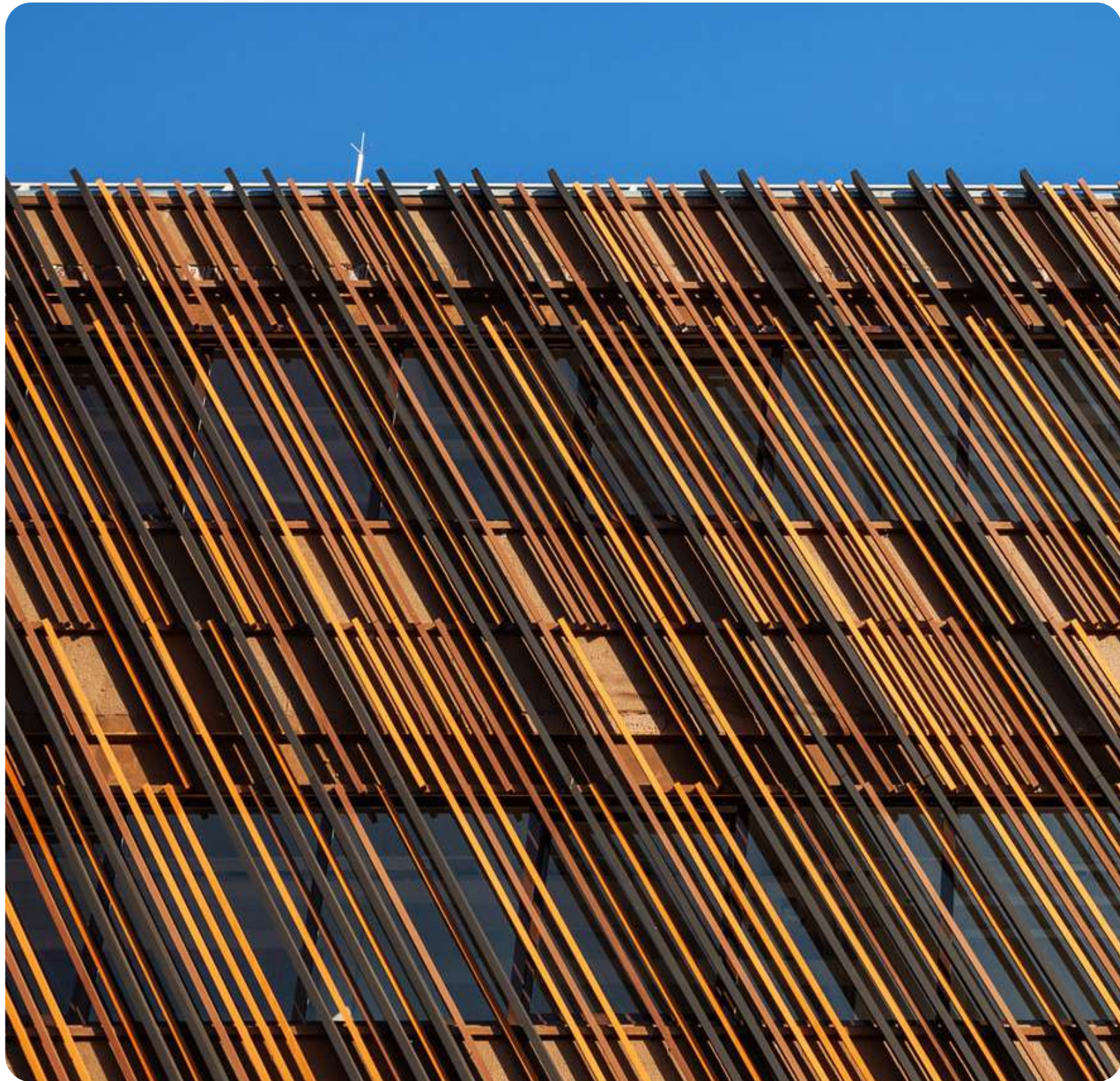





Colégio Nueva Granada - Taller de Arquitectura de Bogotá  
ARKWOOD K 60X30+100X50 AREIA  
Bogotá, Colômbia



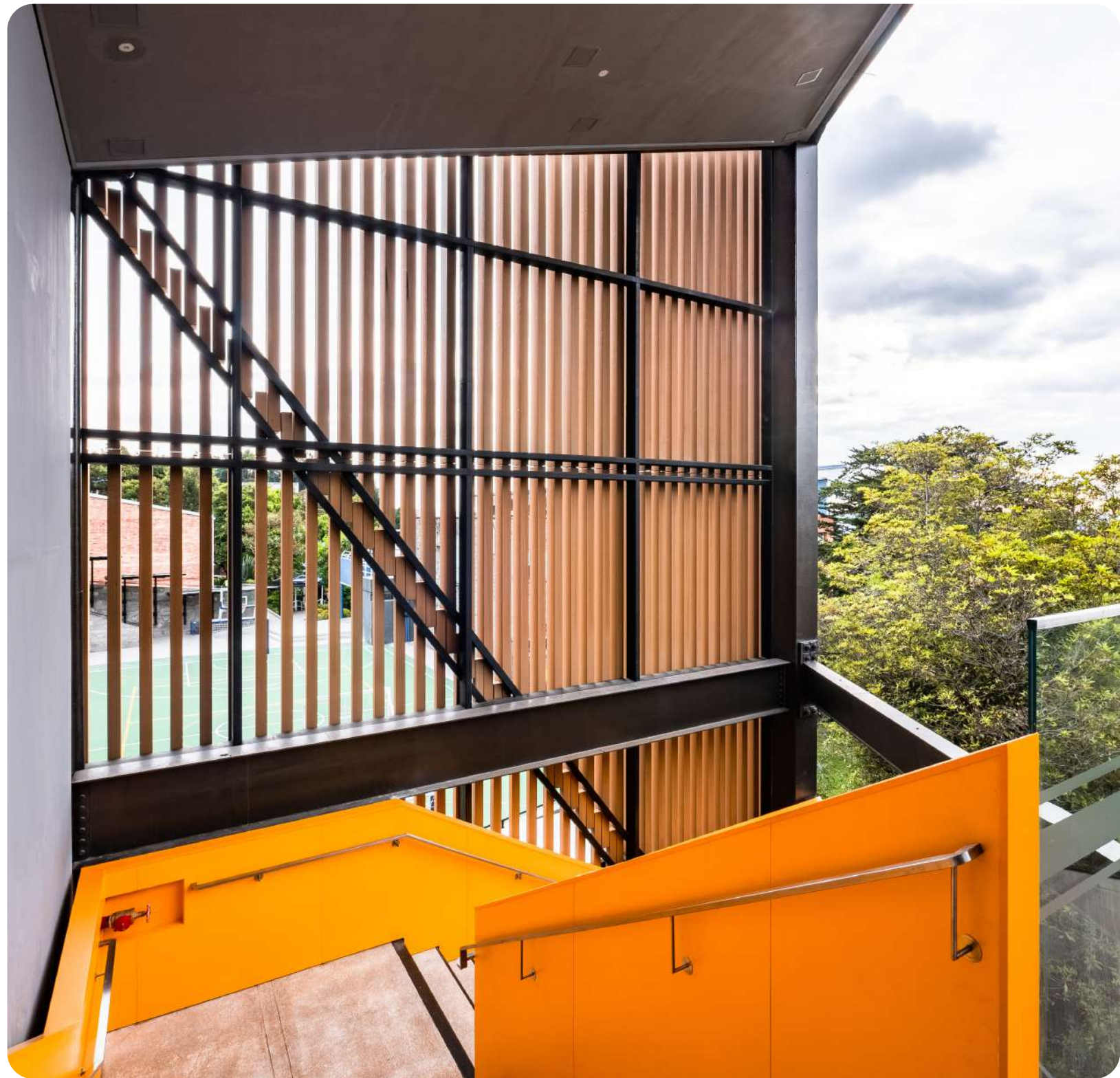













**Restaurante Lonatto - Studio Zeh Arquitetura**

ARKWOOD K 50X30 AREIA

Curitiba, Paraná



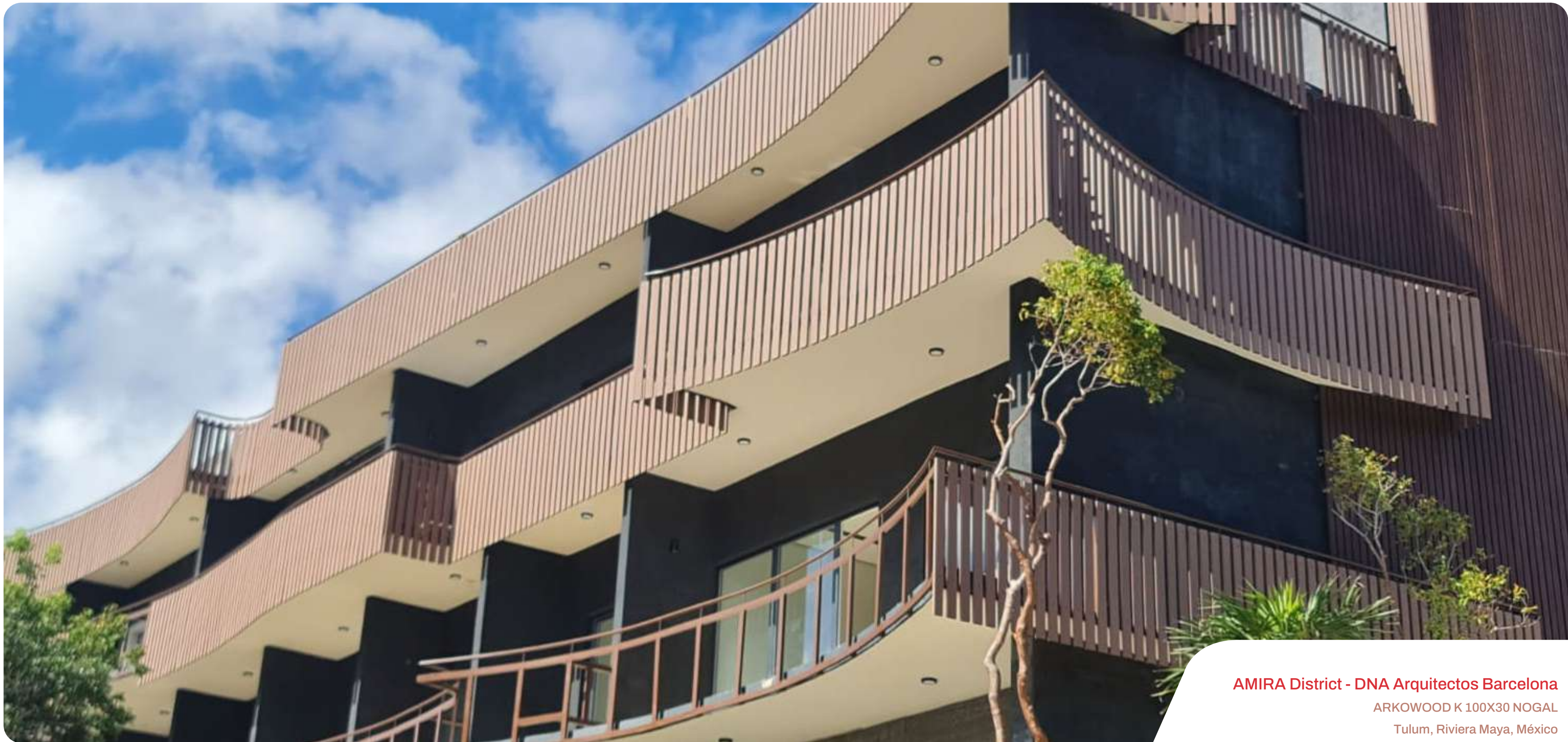

**AMIRA District - DNA Arquitectos Barcelona**

ARKWOOD K 100X30 NOGAL

Tulum, Riviera Maya, México



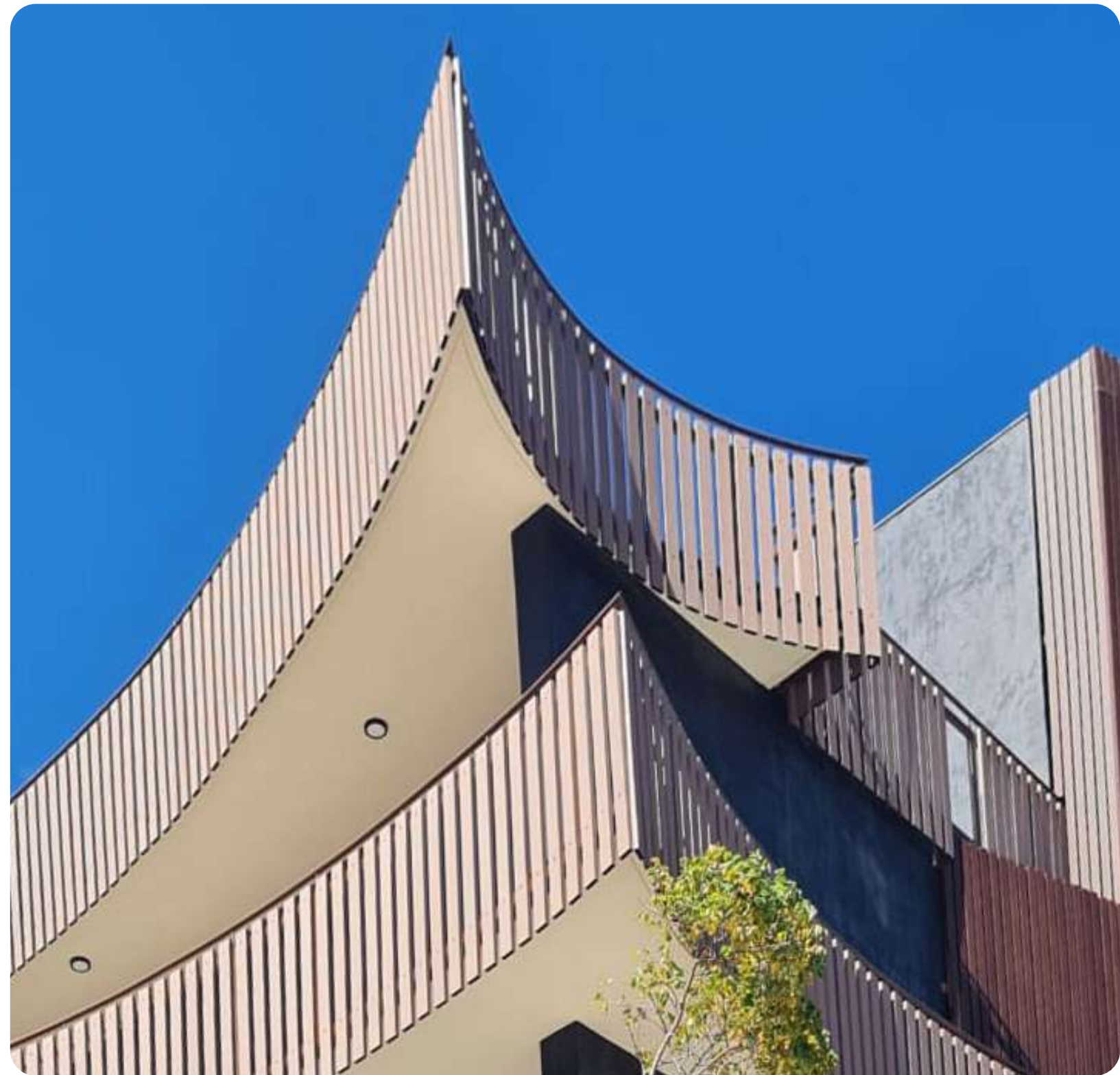





**Escritórios OVD - Ruiz Ferreira Arquitetos**

ARKWOOD K 60X40 NOGAL

Curitiba, Paraná









**Clínica São Vicente - Rede D'Or**  
ARKWOOD K 50X30 AREIA+NOGAL  
Rio de Janeiro, RJ





**Escola Elega São Paulo**  
ARKWOOD K 100X50 AREIA  
It's Informov Arquitetura  
São Paulo, SP



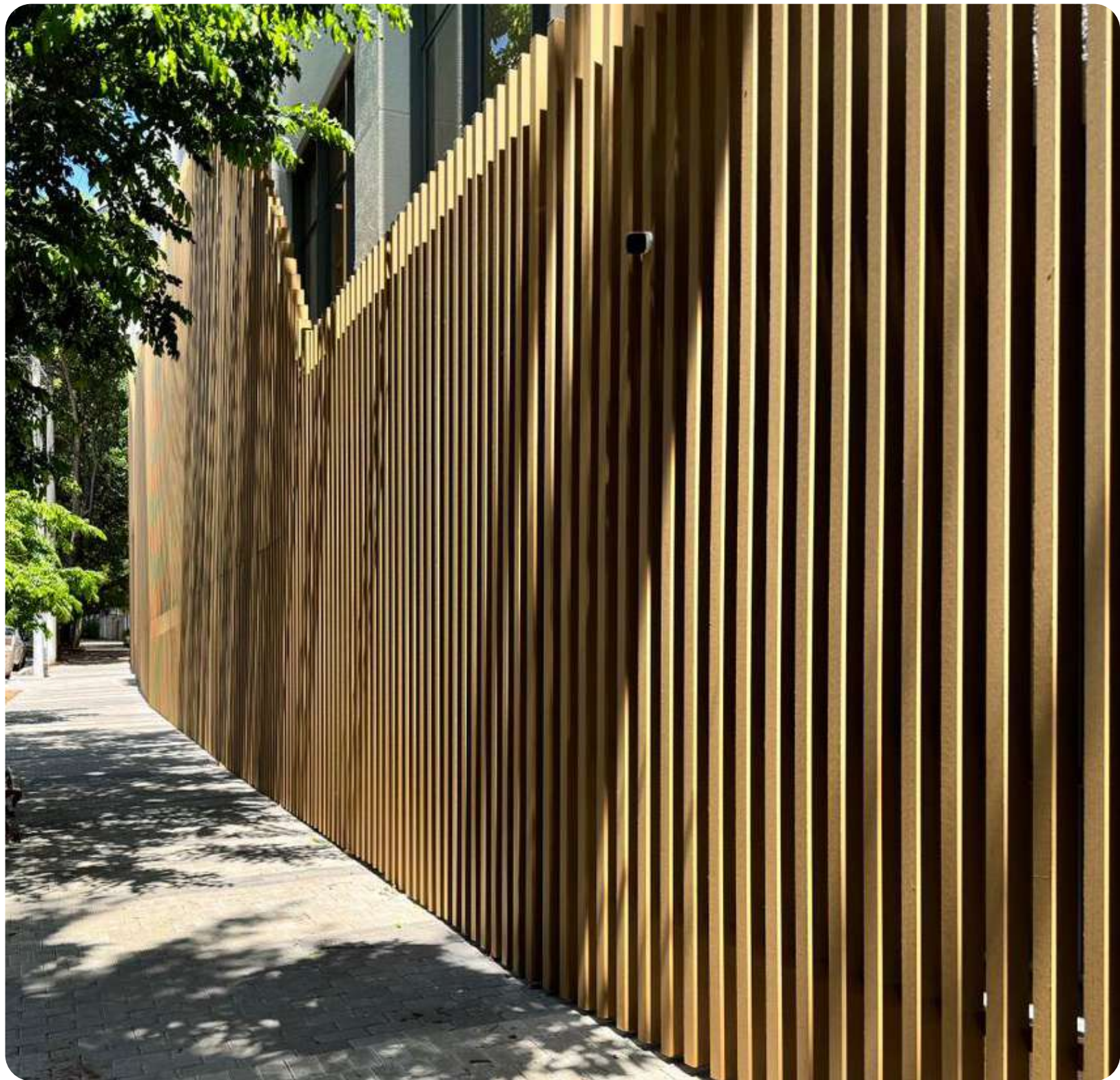





**Beach Tennis - Complexo Esportivo**  
ARKWOOD K AREIA  
São Paulo, SP







arkWOOD K

---

EDIFÍCIOS





**Edifício Lotus Brasília - Lotus Engenharia**

ARKWOOD K 150X50 AREIA

Brasília, Distrito Federal



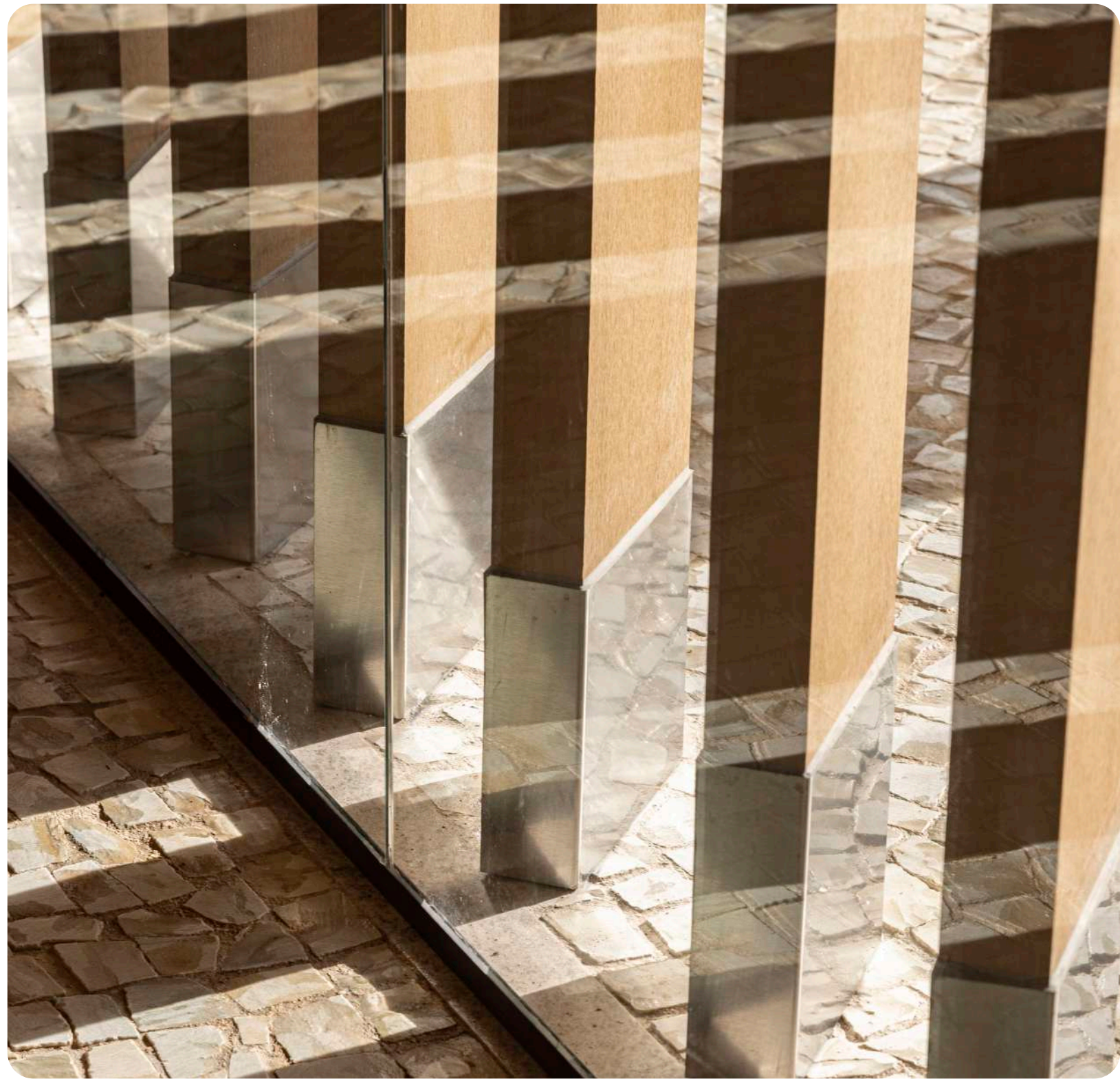
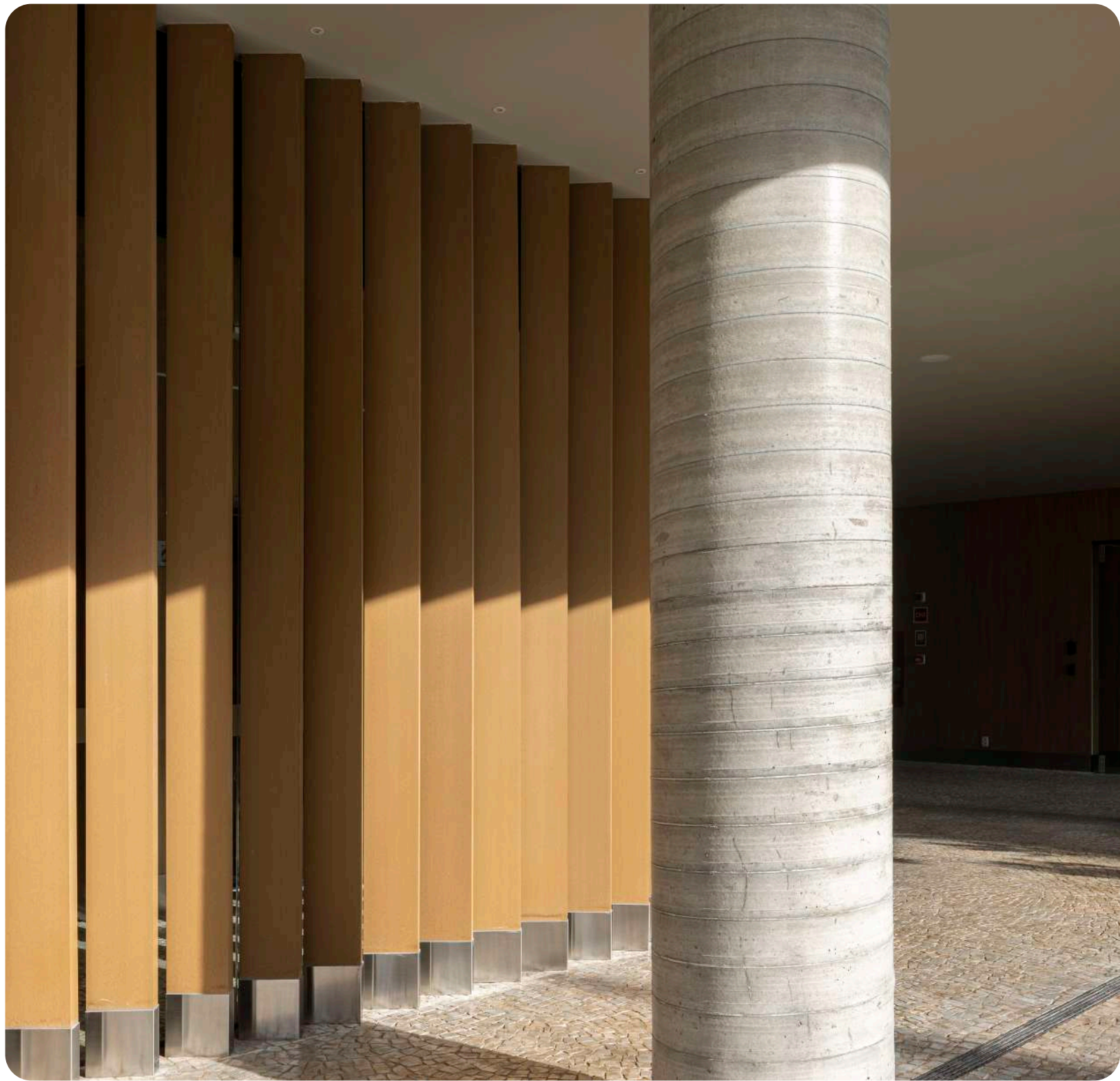





**Casa Lagos Park**  
ARKWOOD K 60X30 CEDRO  
Xangri-lá, RS, Brasil







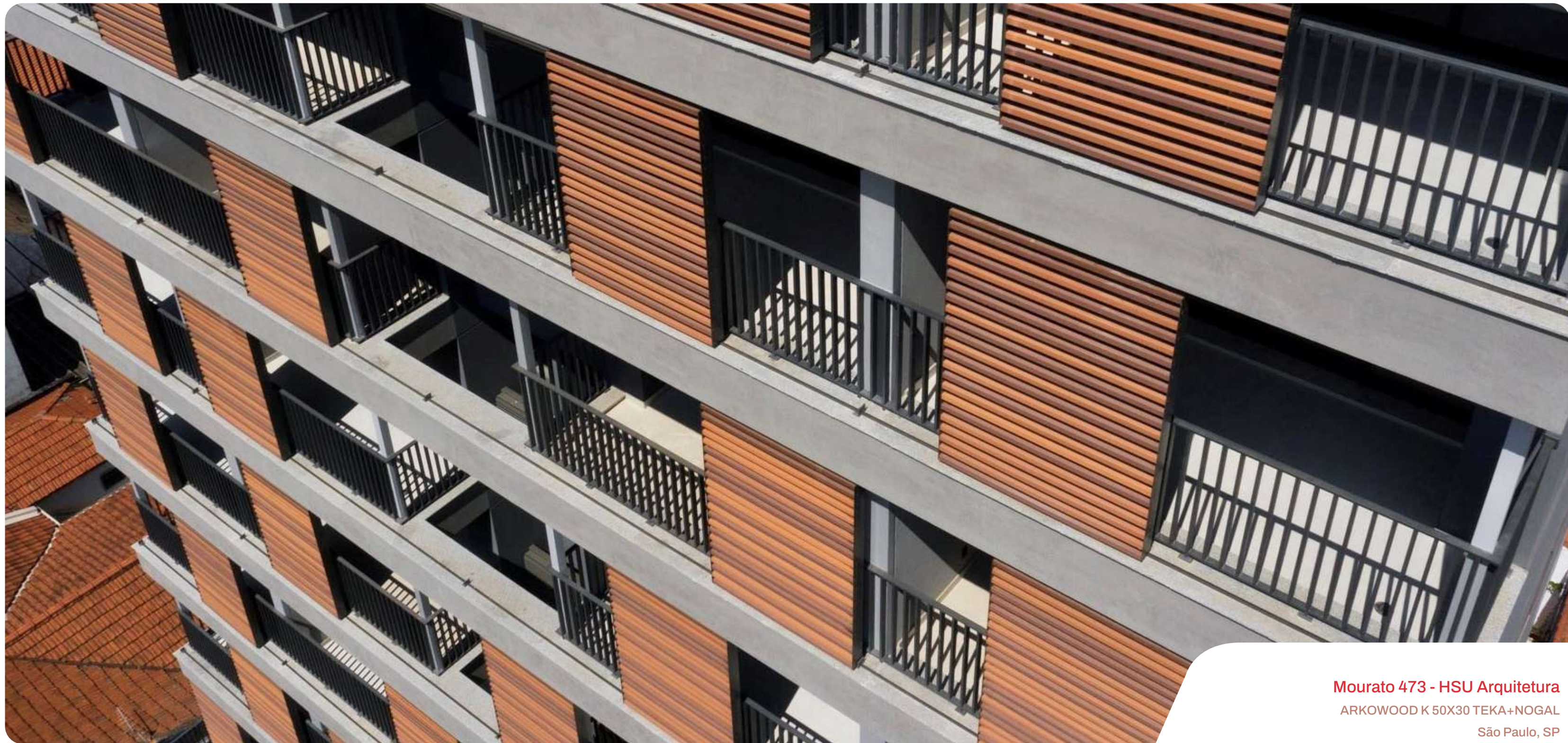

**Mourato 473 - HSU Arquitetura**

ARKWOOD K 50X30 TEKA+NOGAL

São Paulo, SP



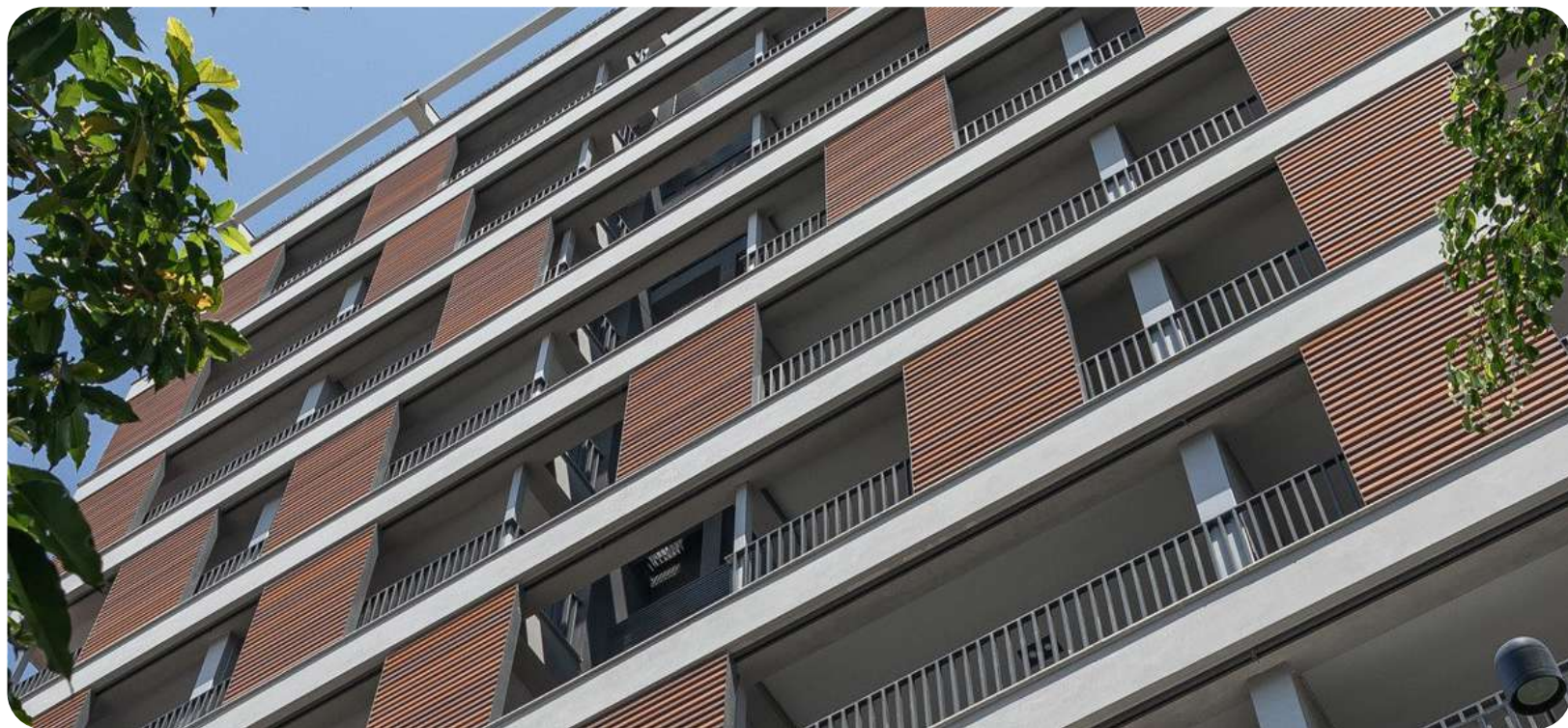



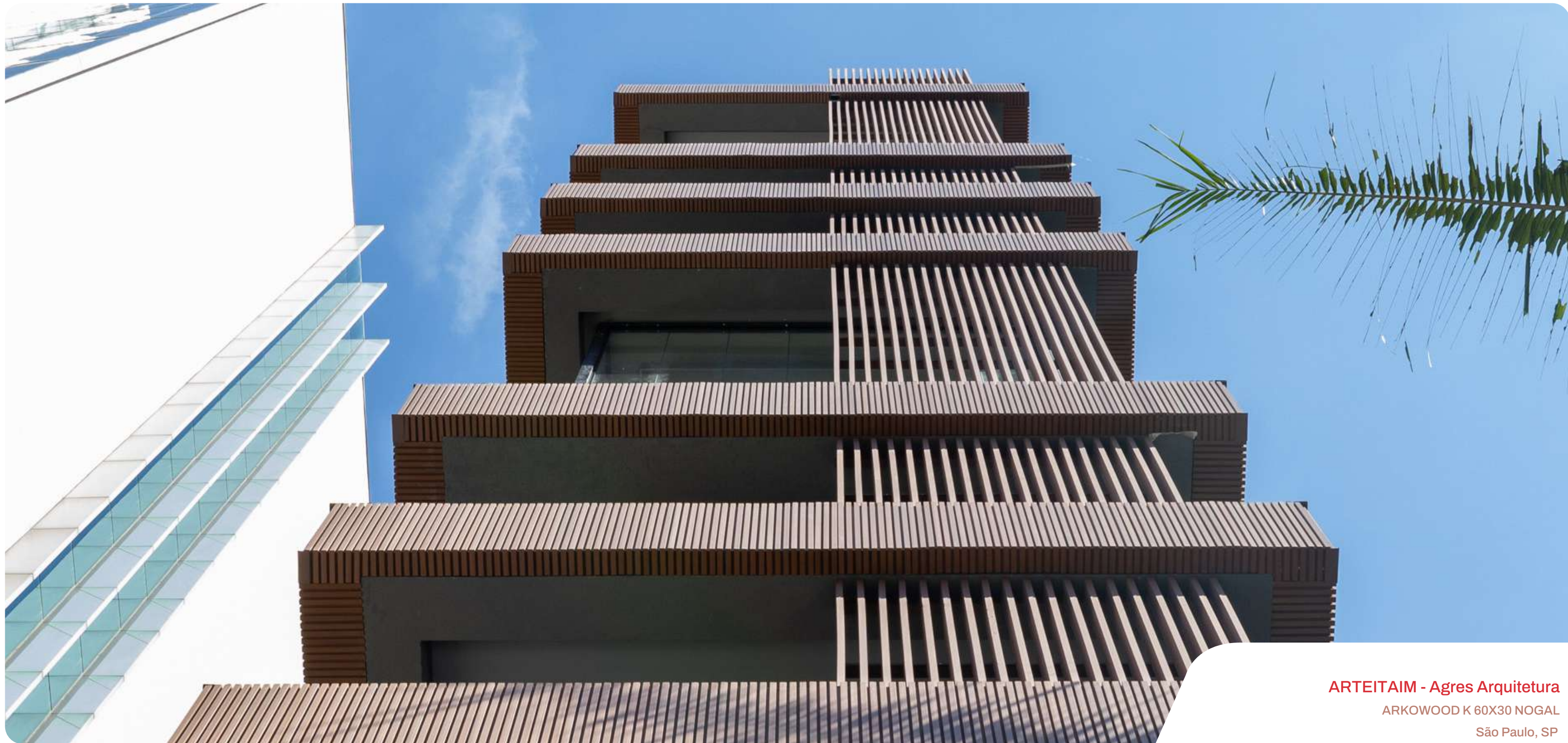

**ARTEITAIM - Agres Arquitetura**

ARKWOOD K 60X30 NOGAL

São Paulo, SP



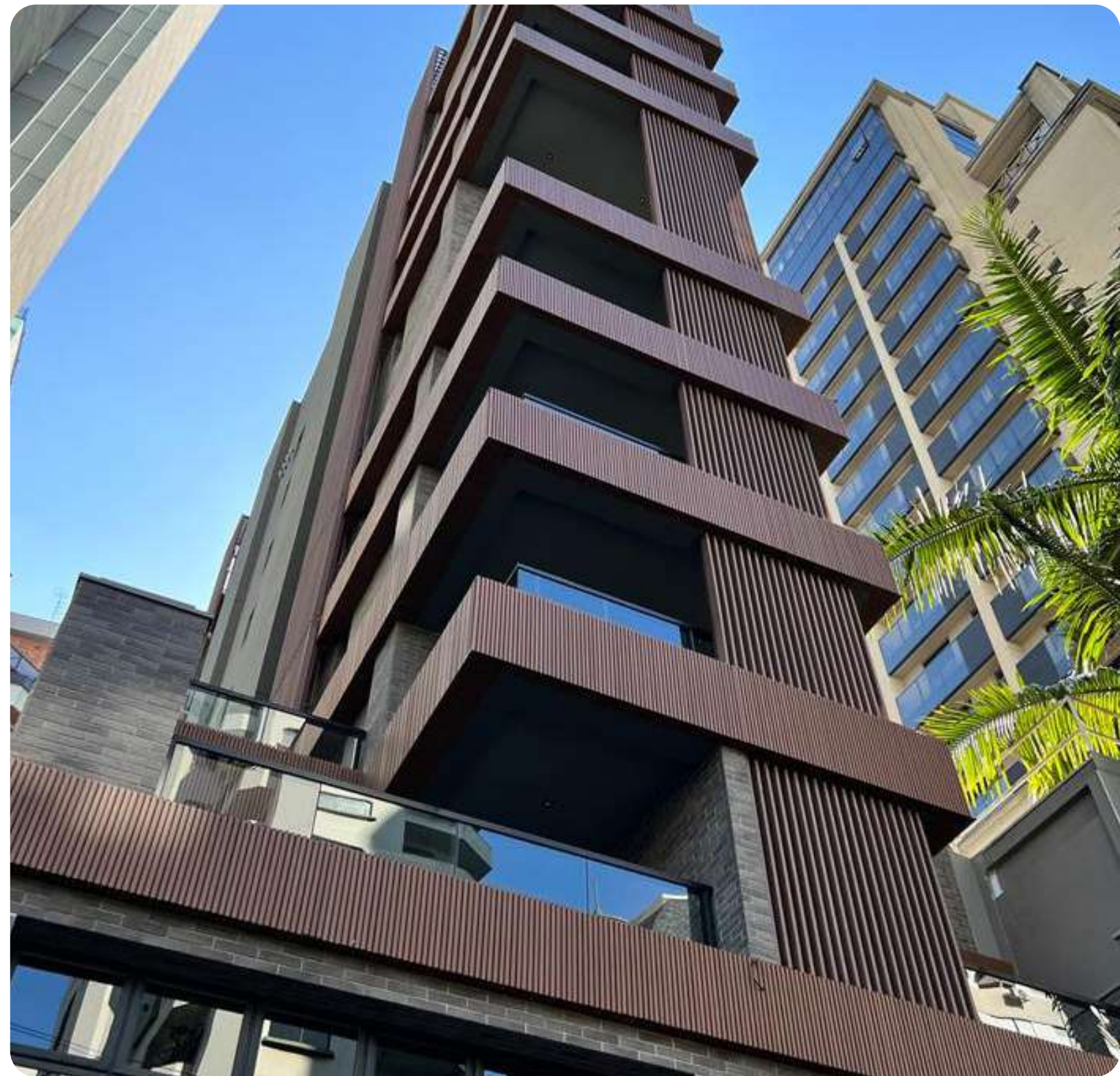
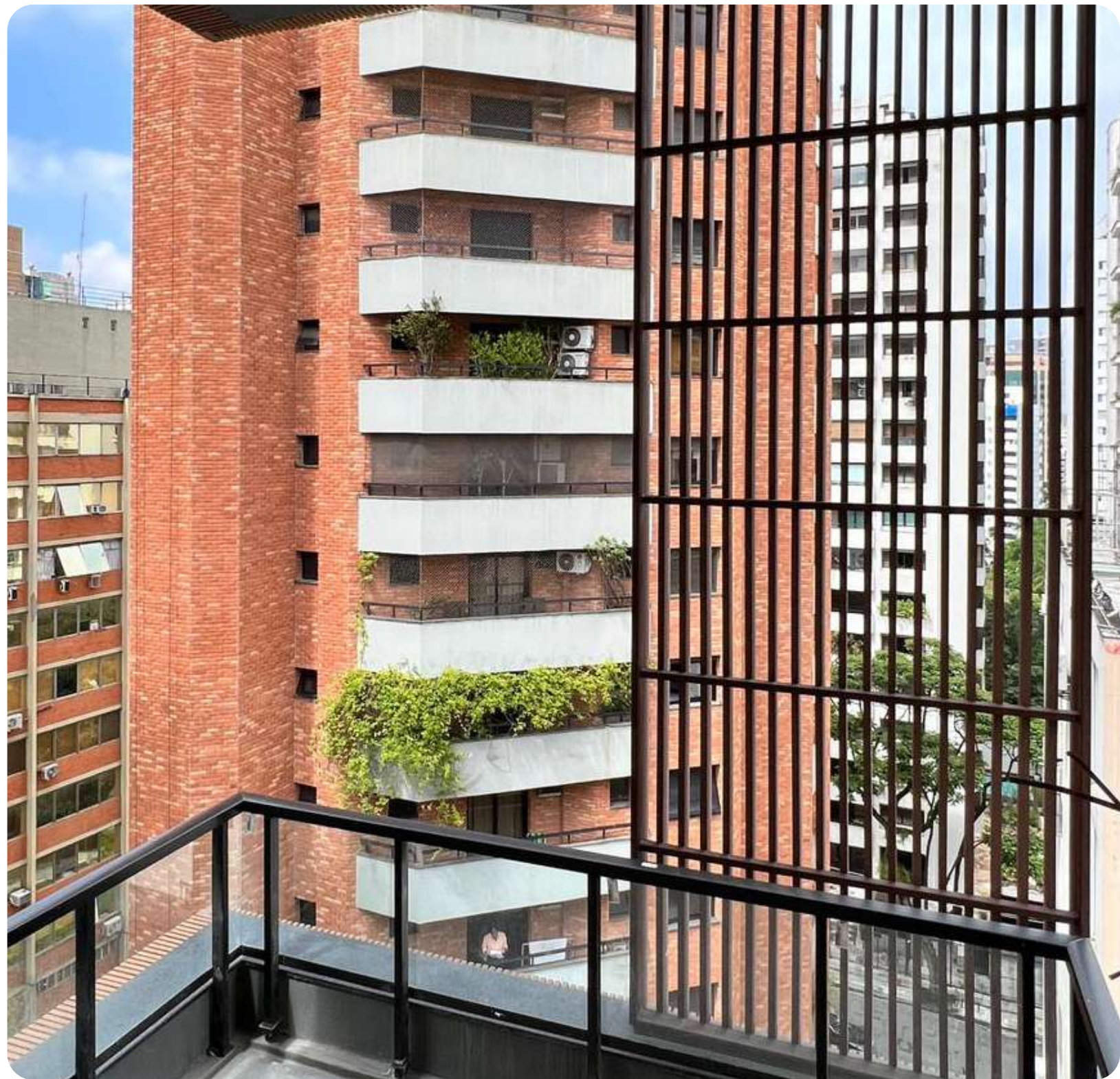





**Edifício Arbo Brooklin - Gui Mattos Arquitetura**

ARKWOOD K 100X30 AREIA

São Paulo, SP







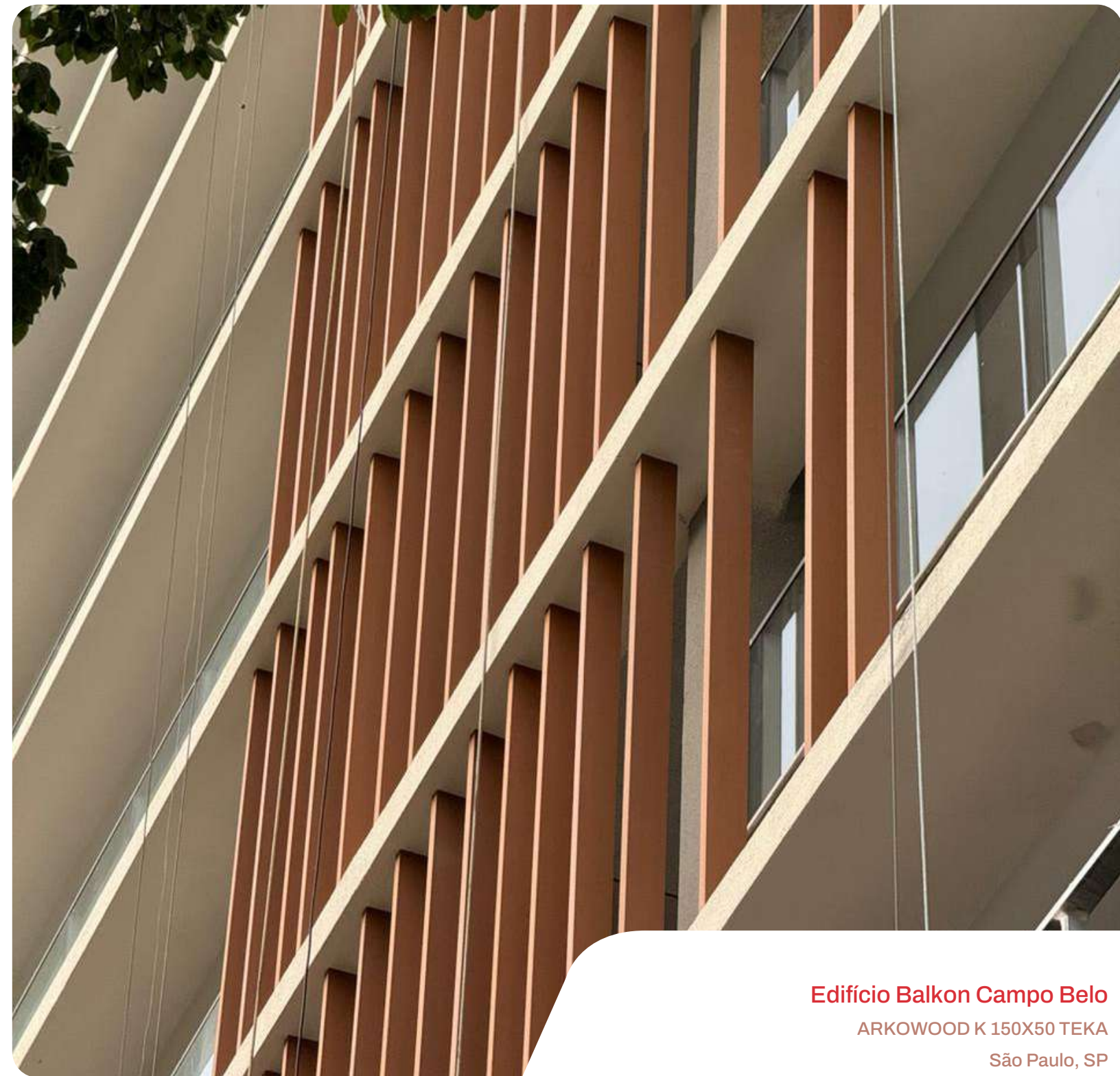

**Edifício Balkon Campo Belo**

ARKWOOD K 150X50 TEKA

São Paulo, SP



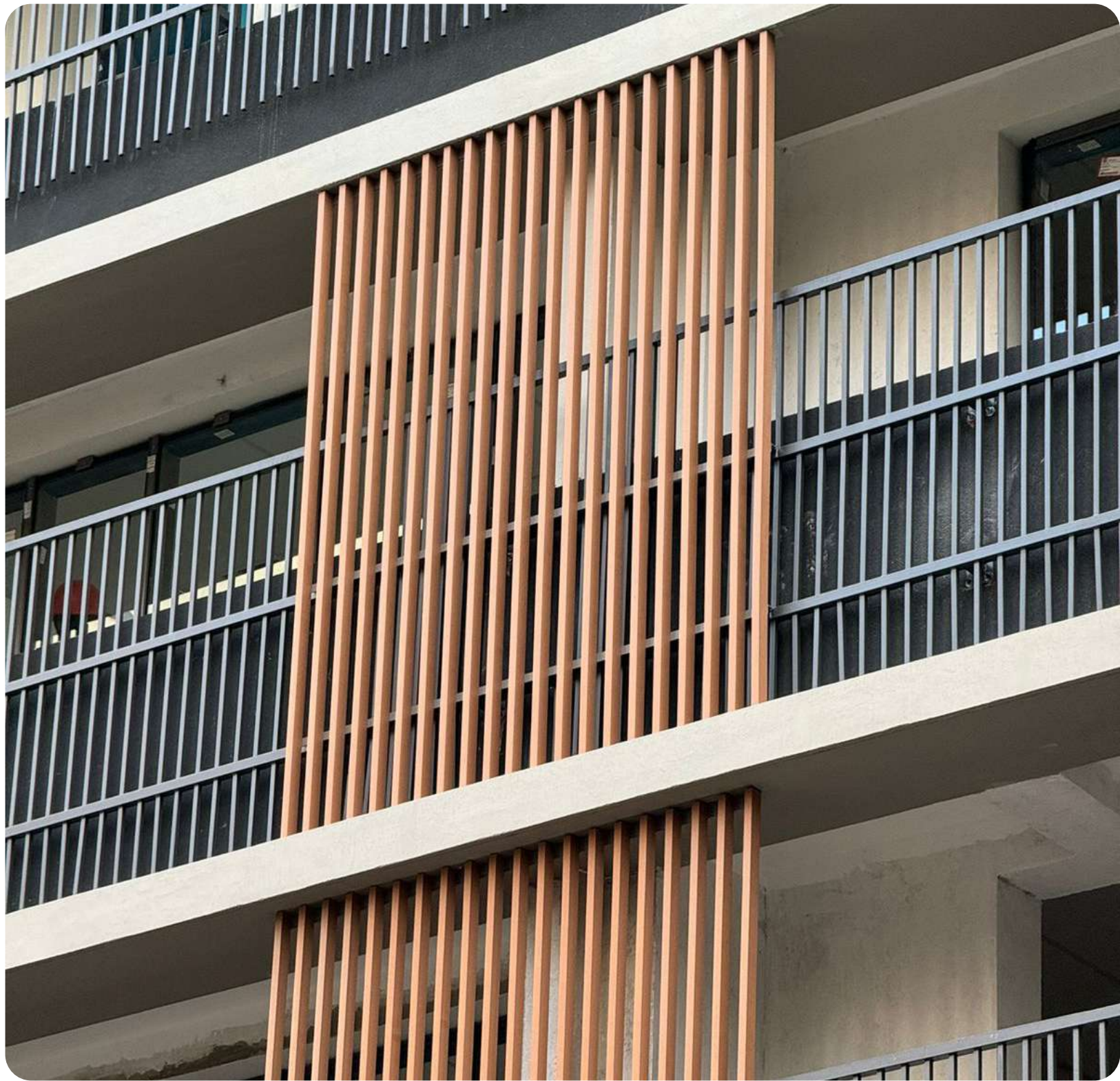





**Residencial Nascentes - Horizontes Arquitetura**

ARKWOOD K 60X30 NOGAL

Nova Lima, Belo Horizonte, Minas Gerais



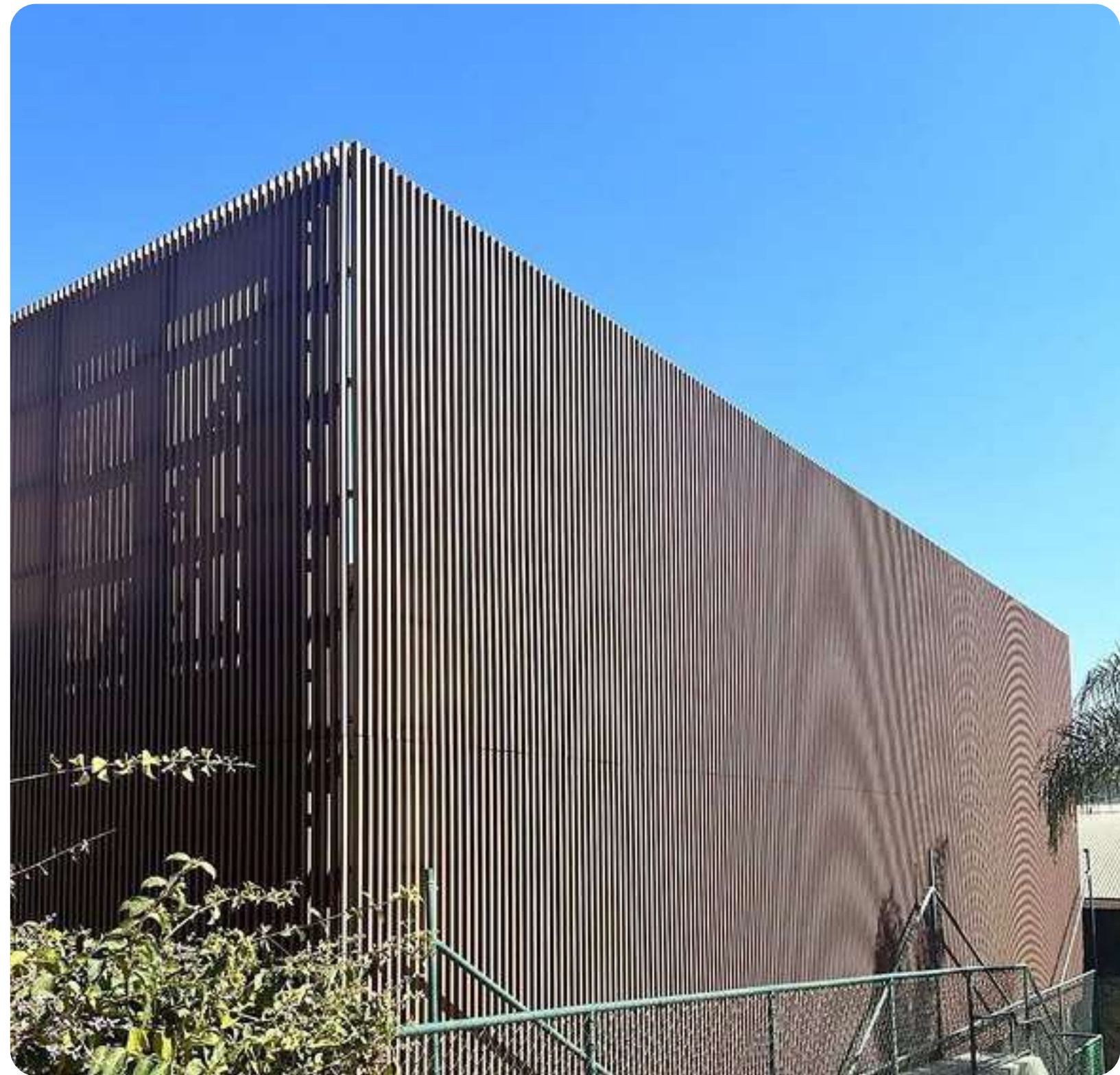



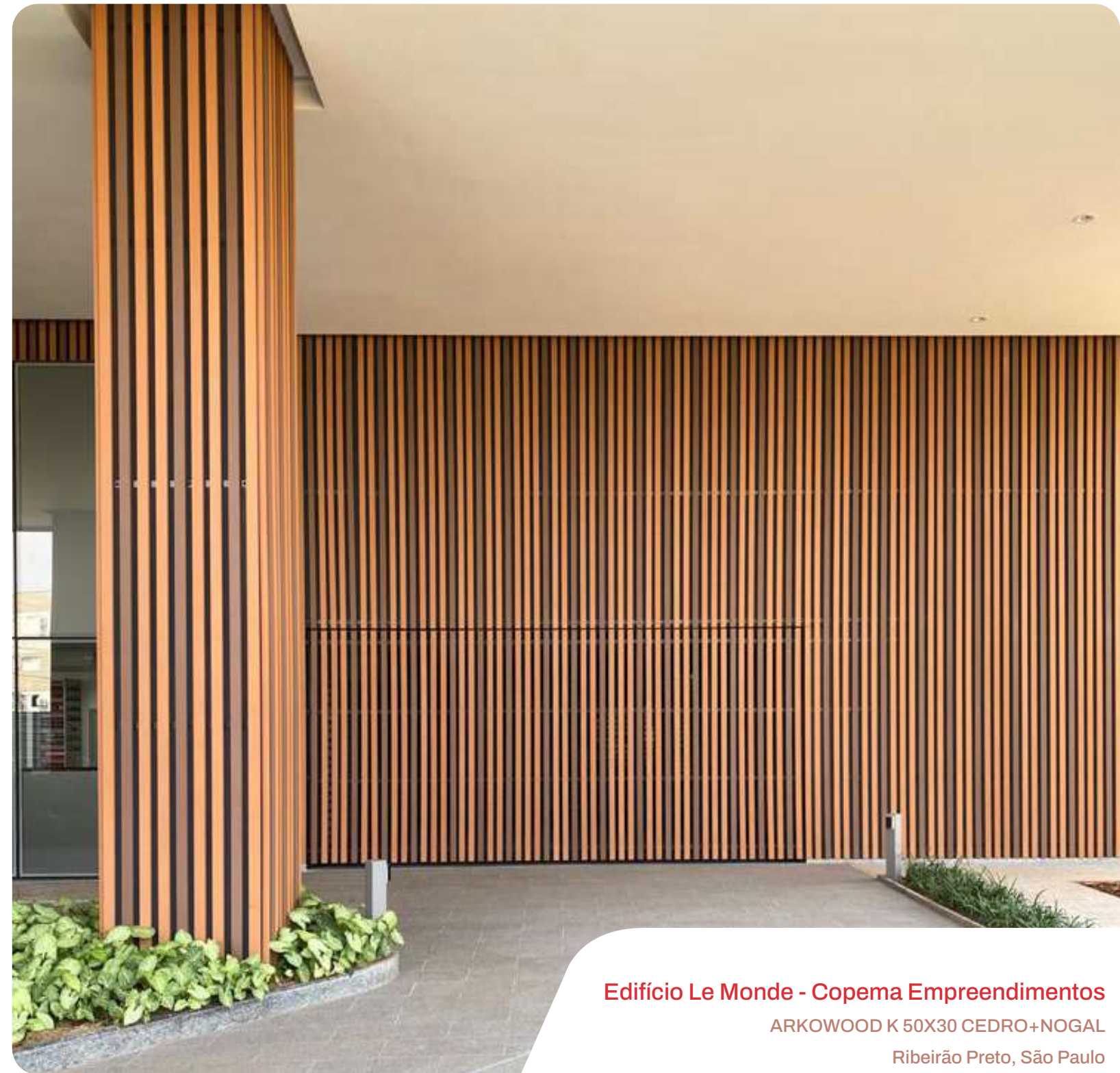

**Edifício Le Monde - Copema Empreendimentos**

ARKWOOD K 50X30 CEDRO+NOGAL

Ribeirão Preto, São Paulo







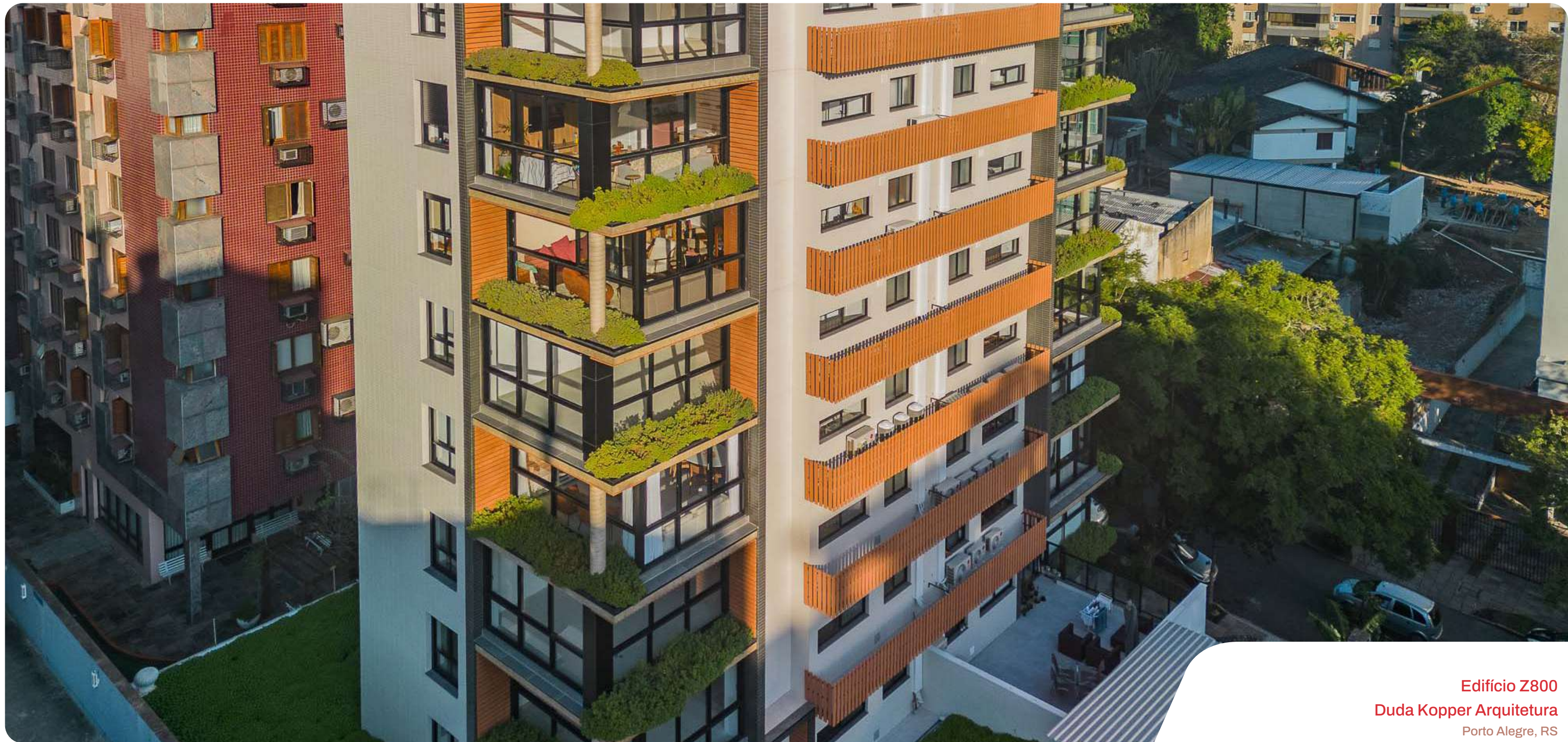

**Edifício Z800**  
**Duda Kopper Arquitetura**  
Porto Alegre, RS



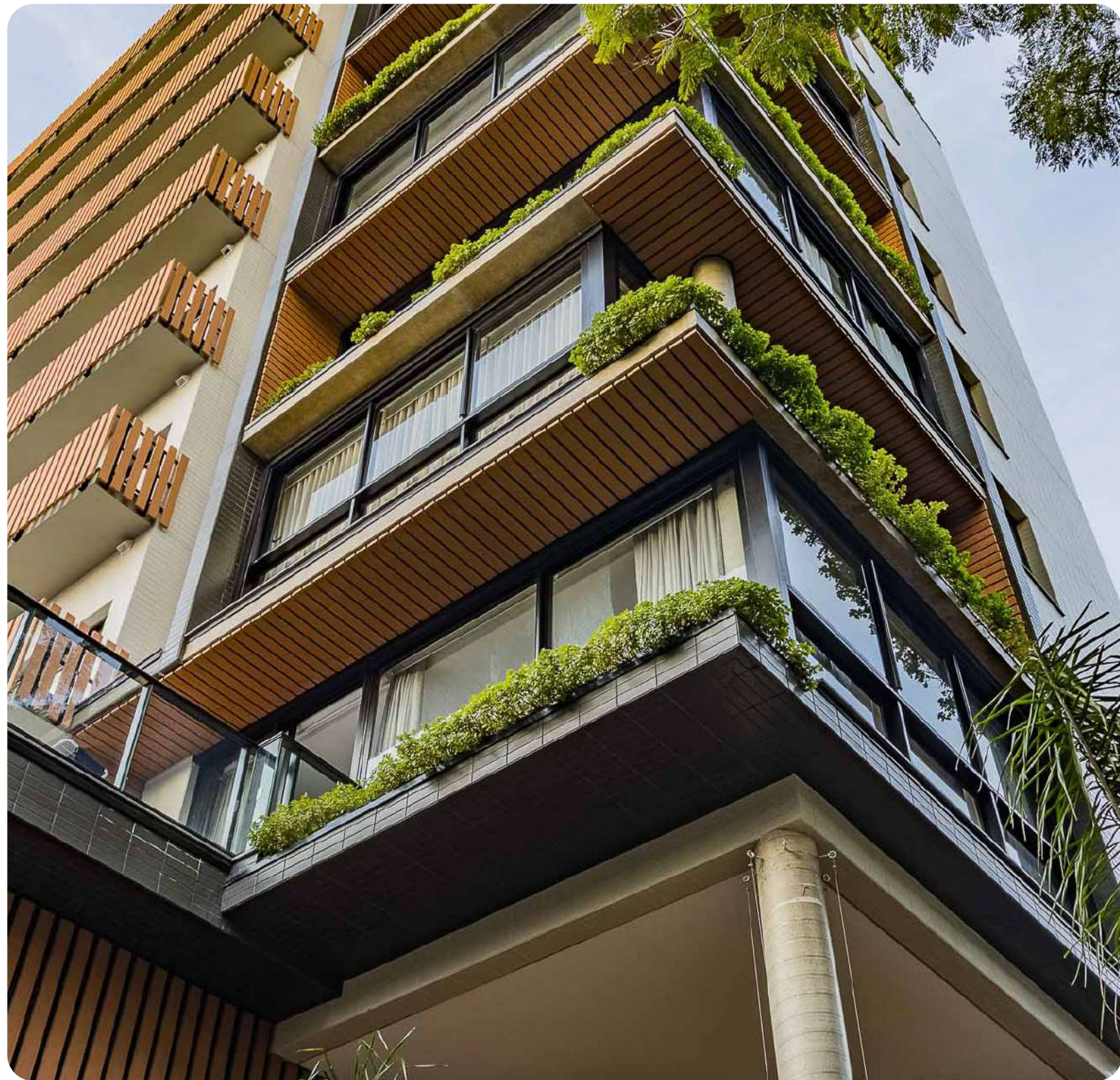



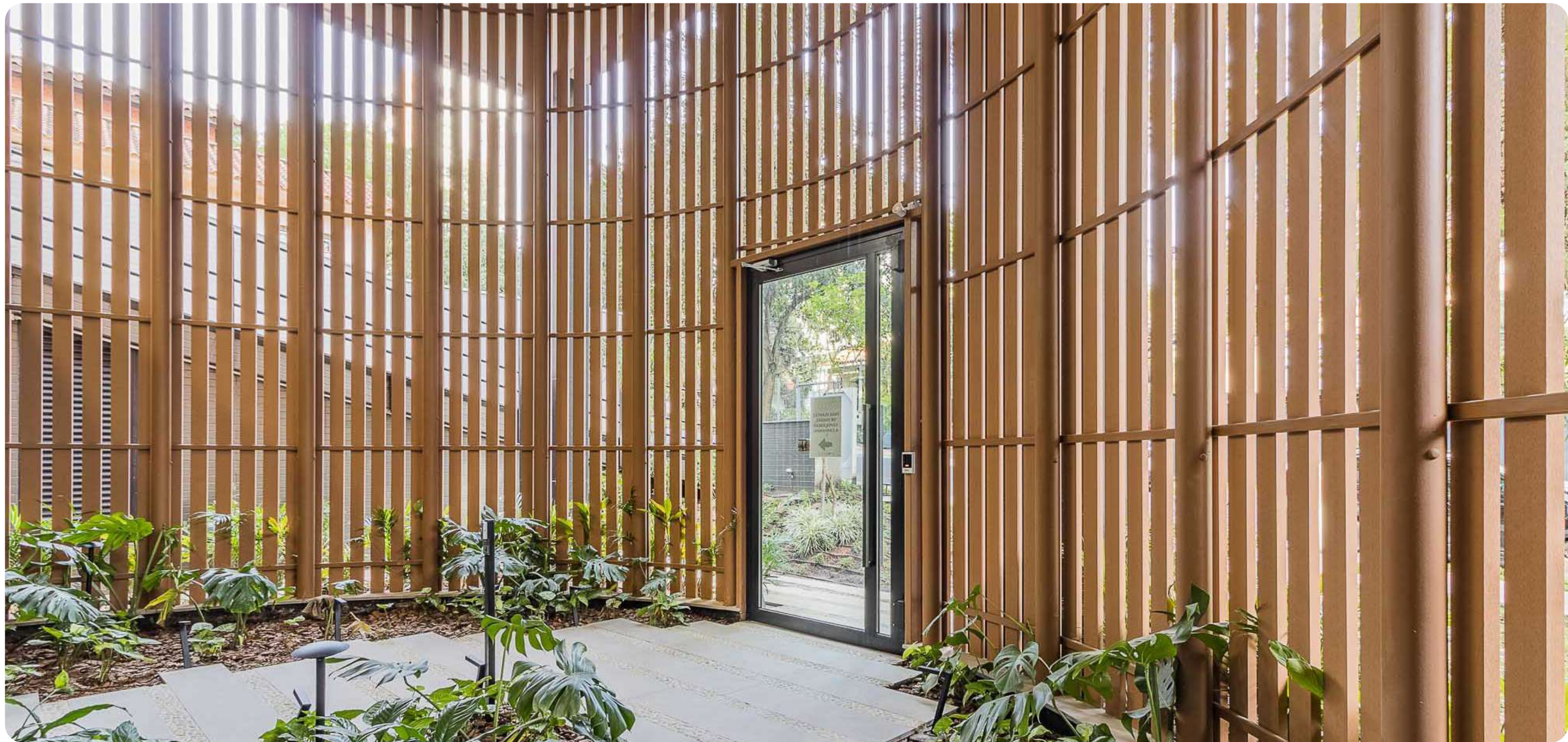



arkWOOD K

---

INTERIORES





**Escritórios Arkos Colômbia - Calle 80**  
ARKWOOD K 60X30 NOGAL + 100X30 PRETO  
Bogotá, Colômbia



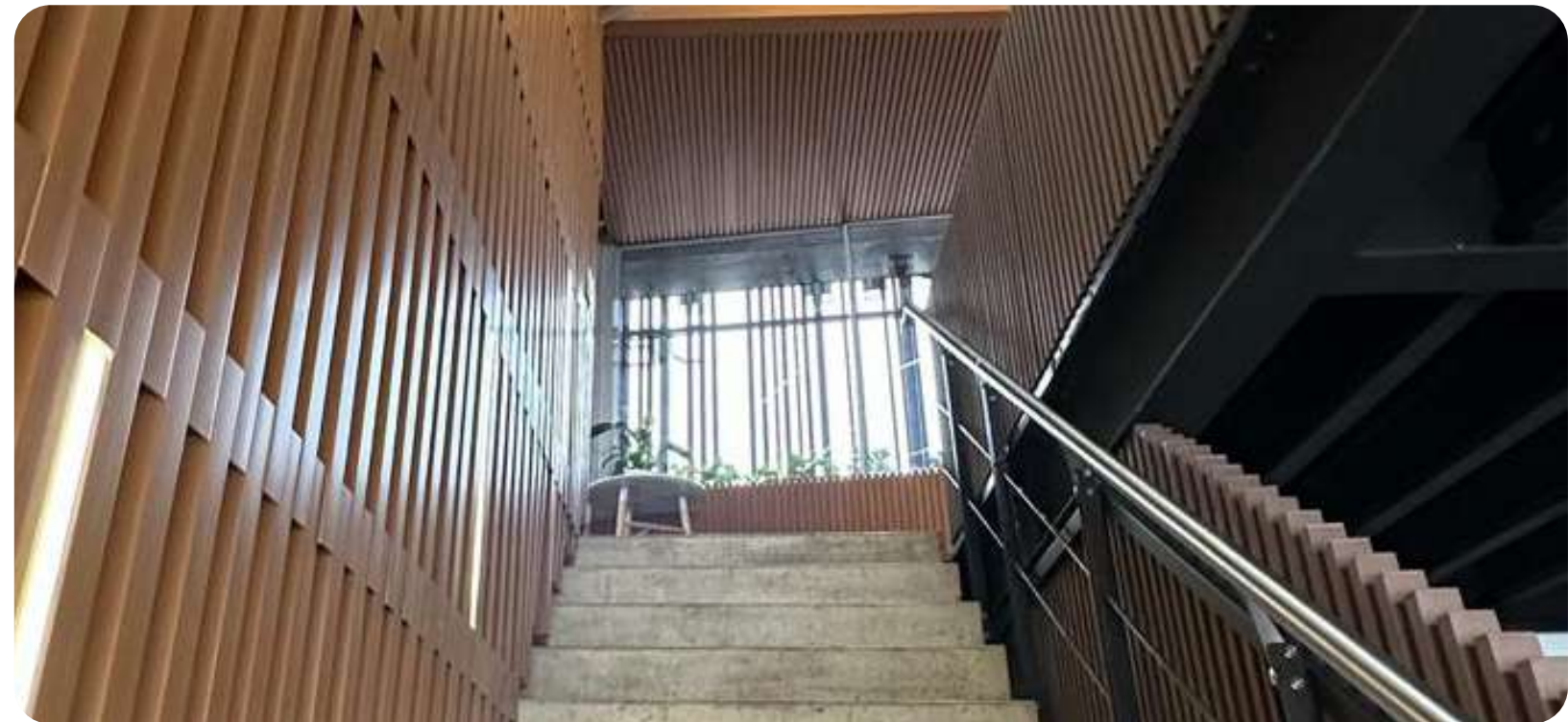
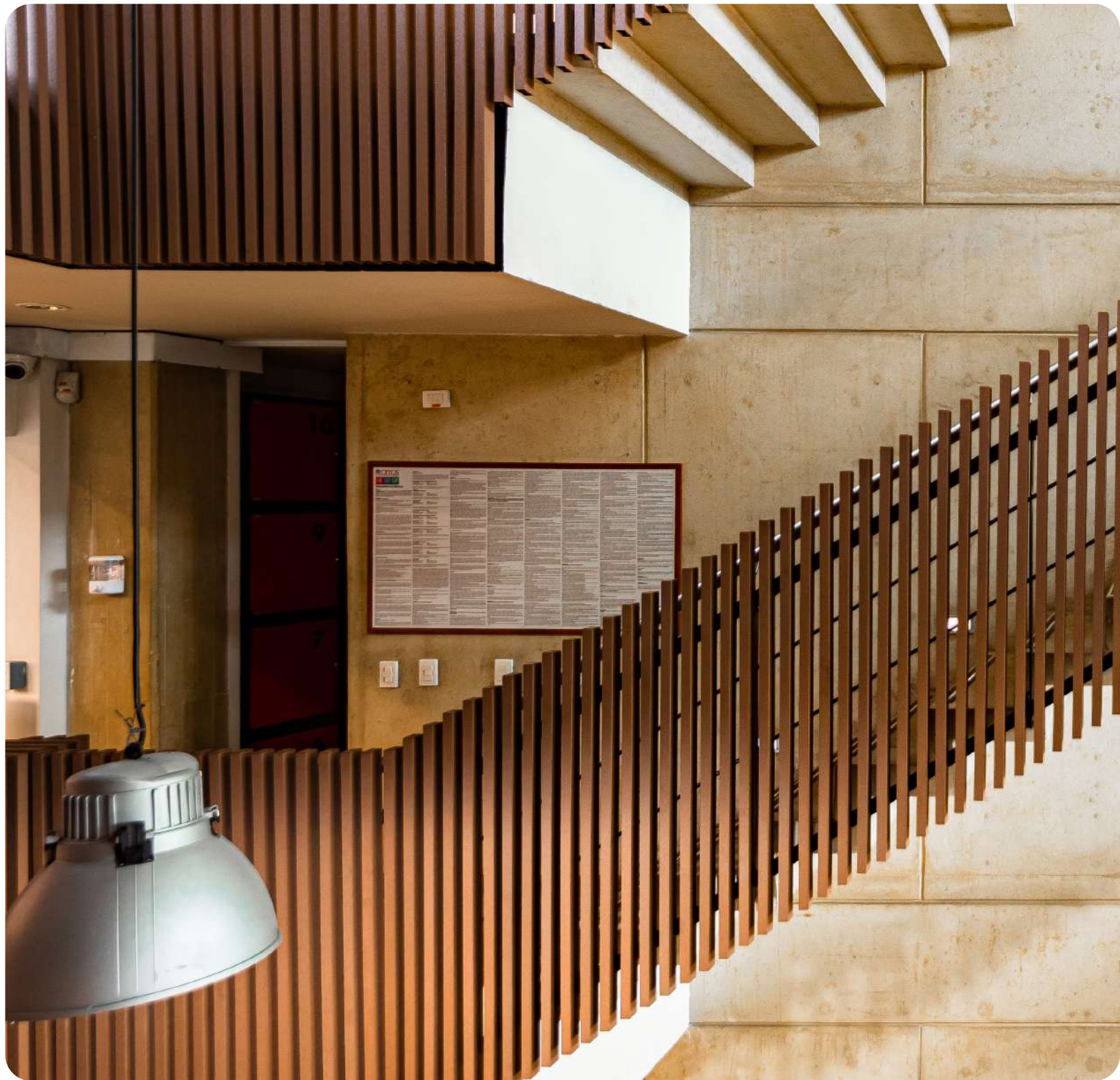





Loja Luka  
FFRG Arquitetos  
Porto Velho, Rondônia







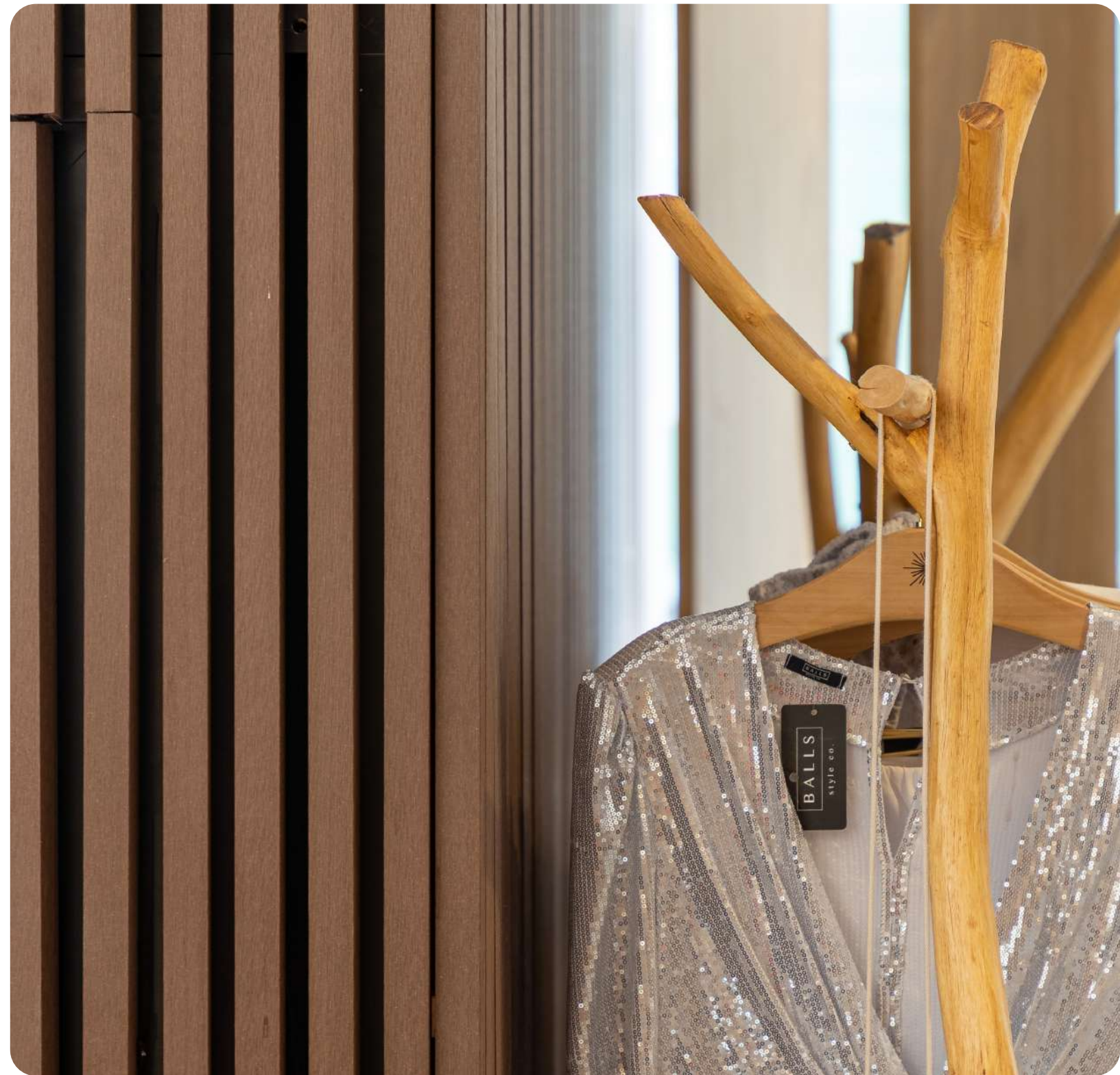



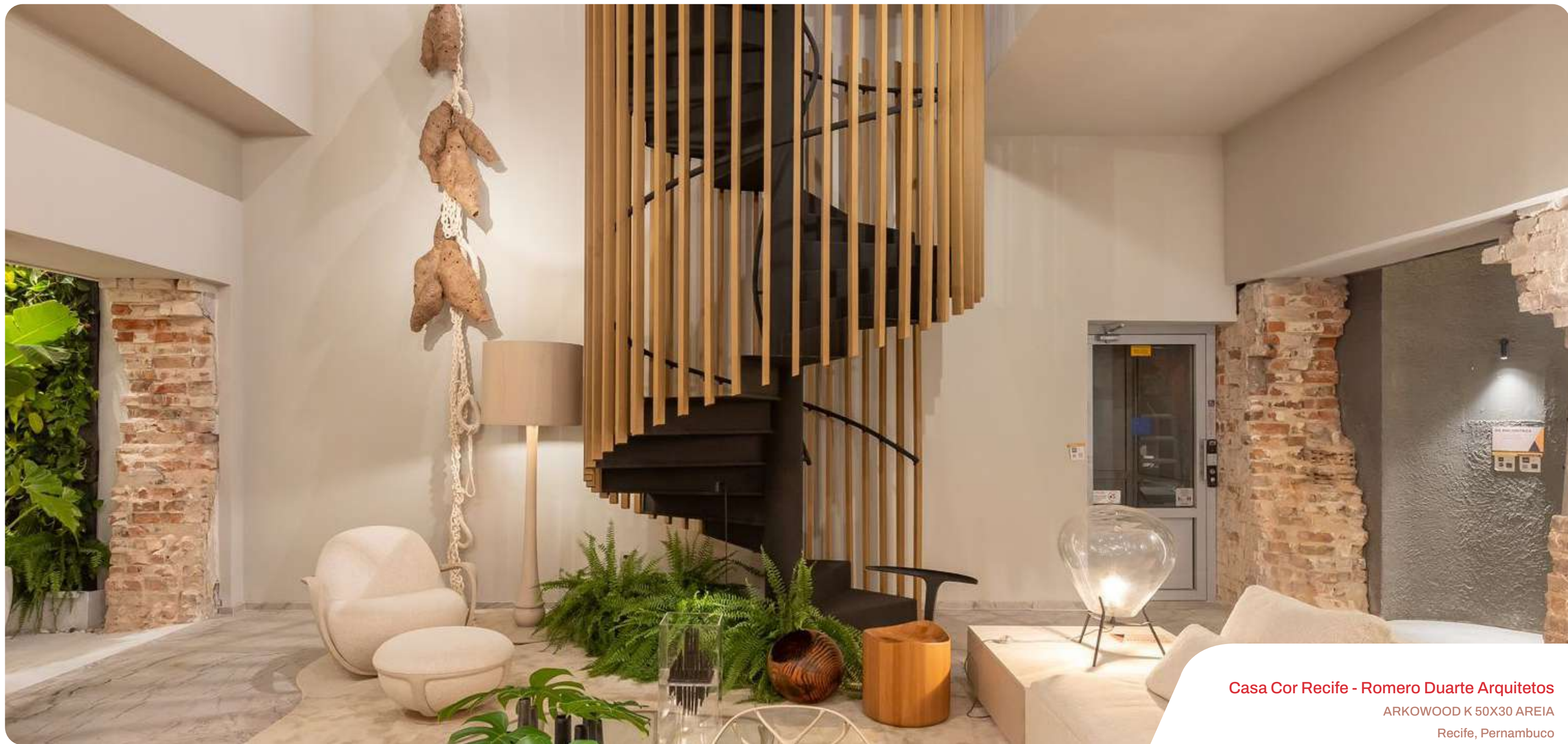

**Casa Cor Recife - Romero Duarte Arquitetos**

ARKWOOD K 50X30 AREIA

Recife, Pernambuco



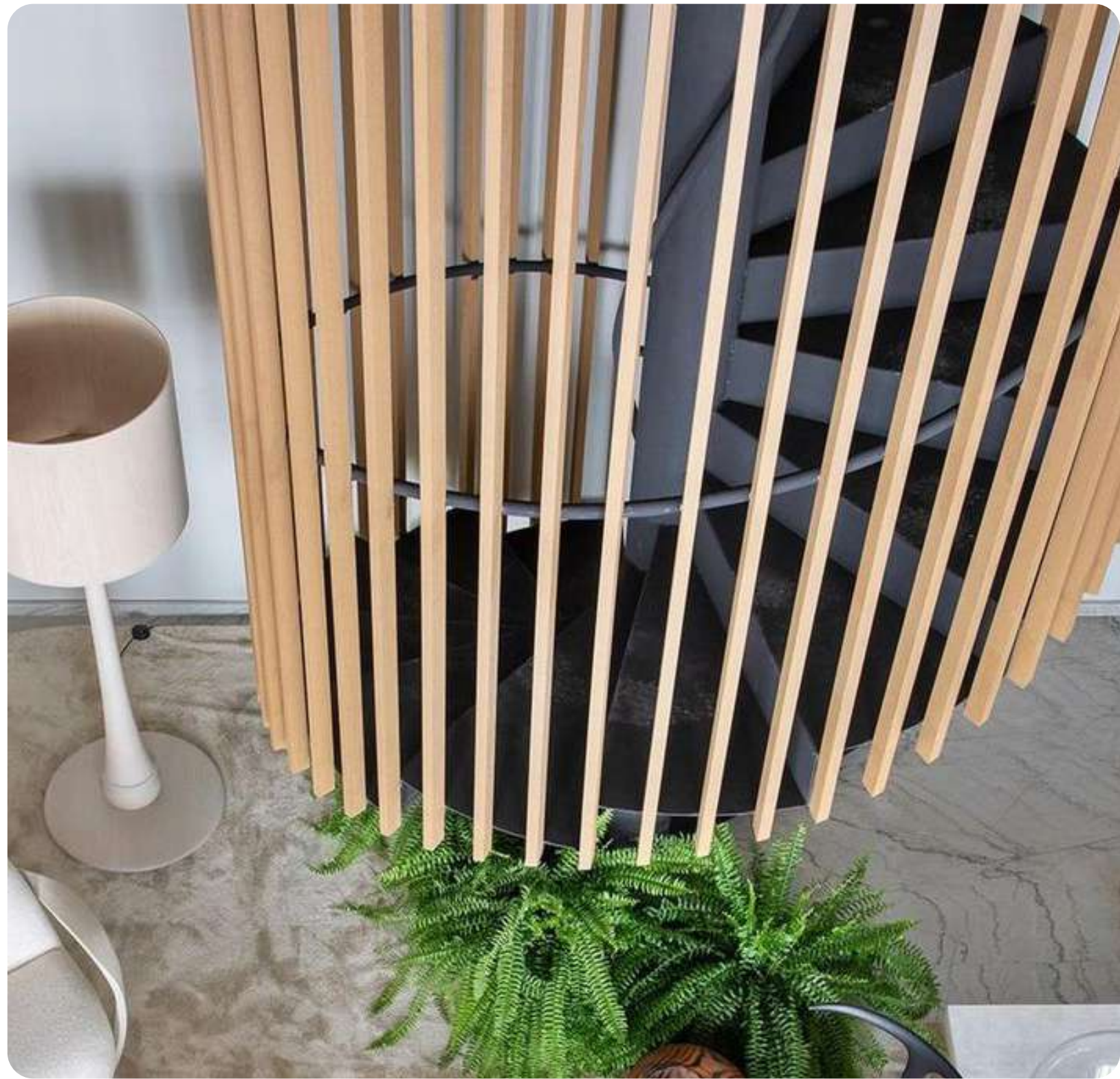





**Edifício Arbo Brooklin - Gui Mattos Arquitetura**

ARKWOOD K 60X30 TEKA

São Paulo, SP



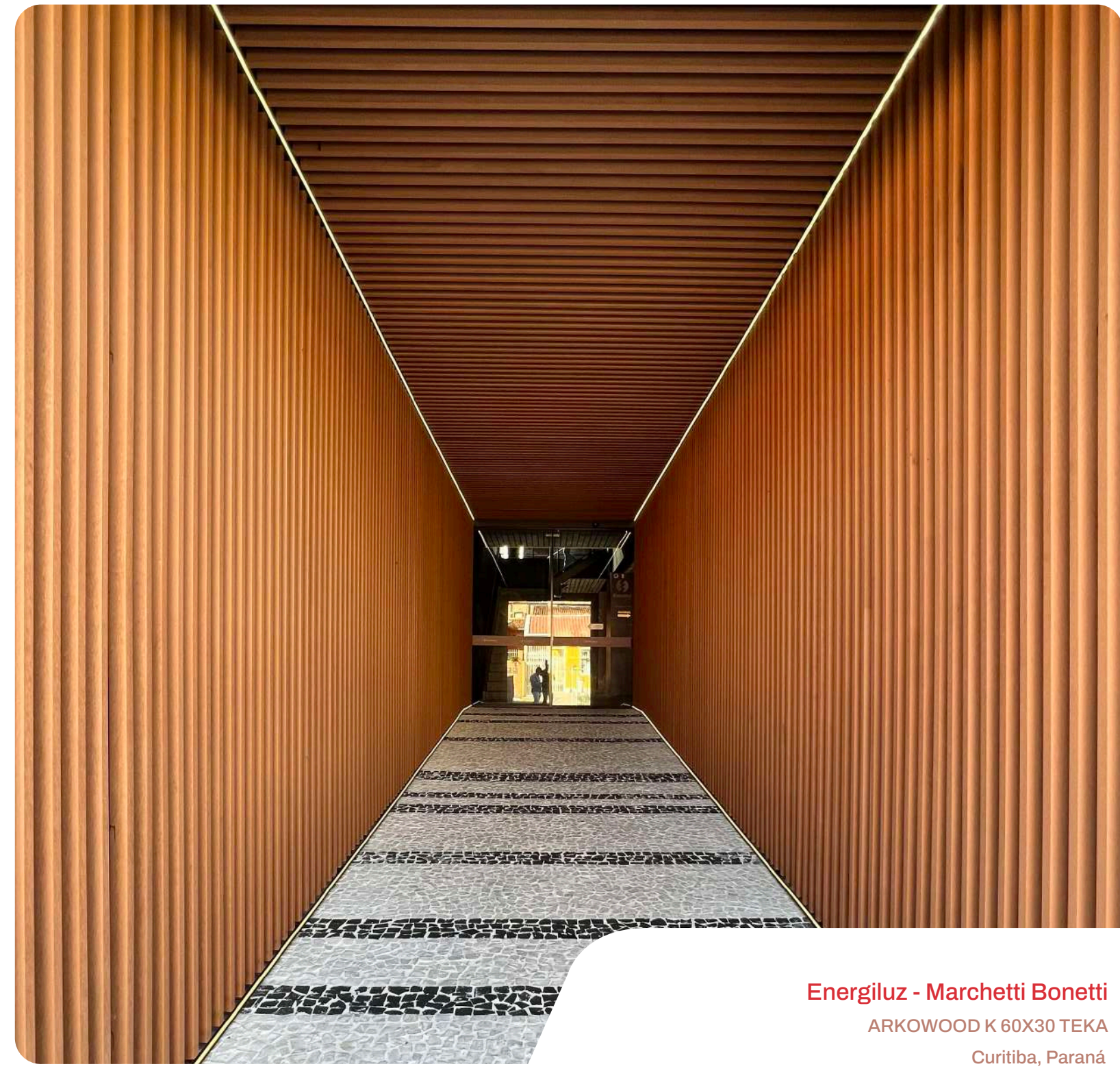
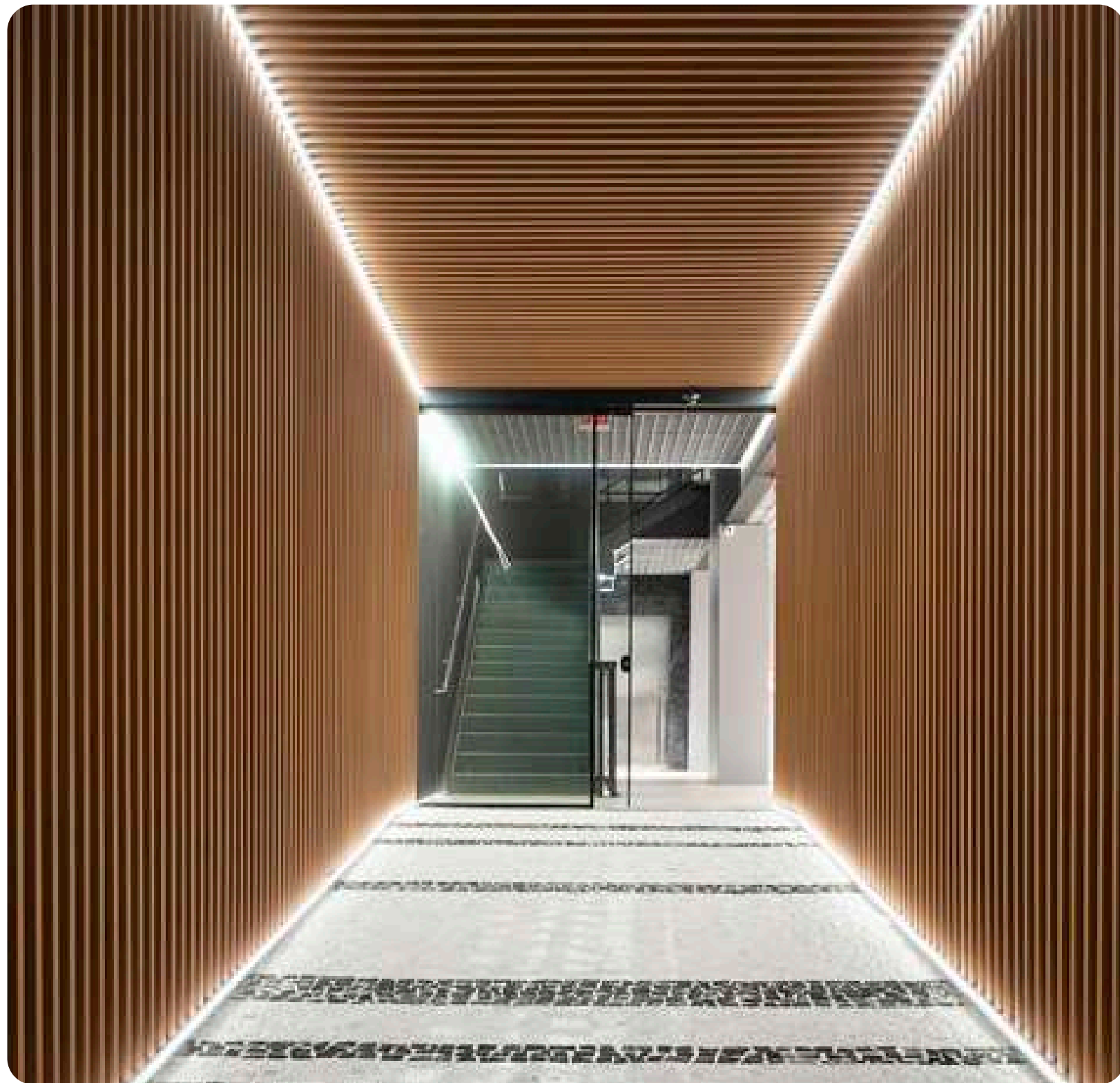

**Energiluz - Marchetti Bonetti**  
ARKWOOD K 60X30 TEKA  
Curitiba, Paraná





**Banheiro em residência**  
ARKWOOD K 50X30 NOGAL  
São Paulo, SP



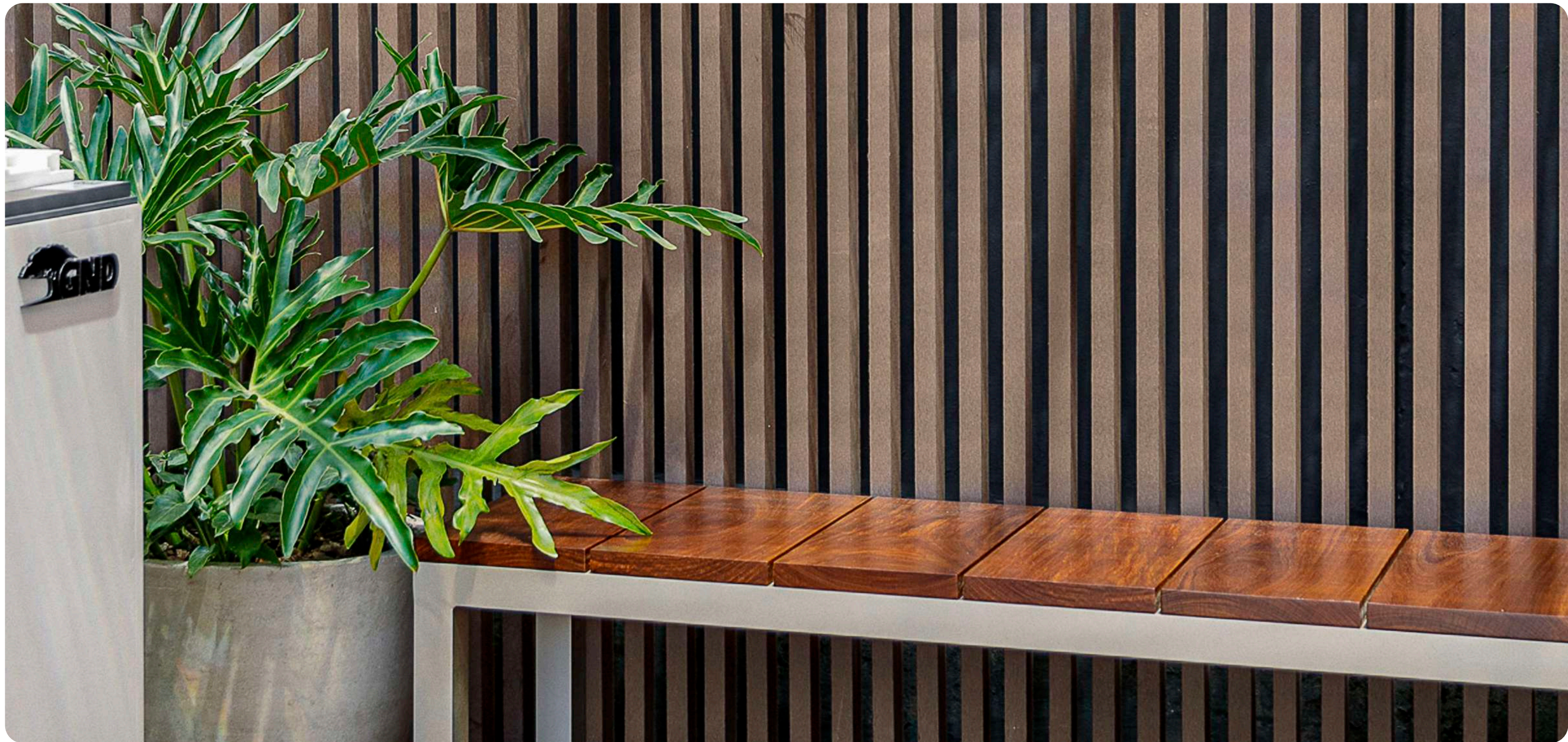





**Apartamento AL - Duas Arquitetura**  
ARKWOOD K 50X30 AREIA  
São Paulo, SP





**Casa Prática - Studio Zargos**  
ARKWOOD K 50X30 TEKA E NOGAL  
Belo Horizonte, Minas Gerais



# ARKWOOD K

SISTEMA ARKWOOD K 50 x 30mm / 5.6 MTS DE COMPRIMENTO

(VALORES EM METRO QUADRADO)

Sugestão 1

R\$ 648/M<sup>2</sup>

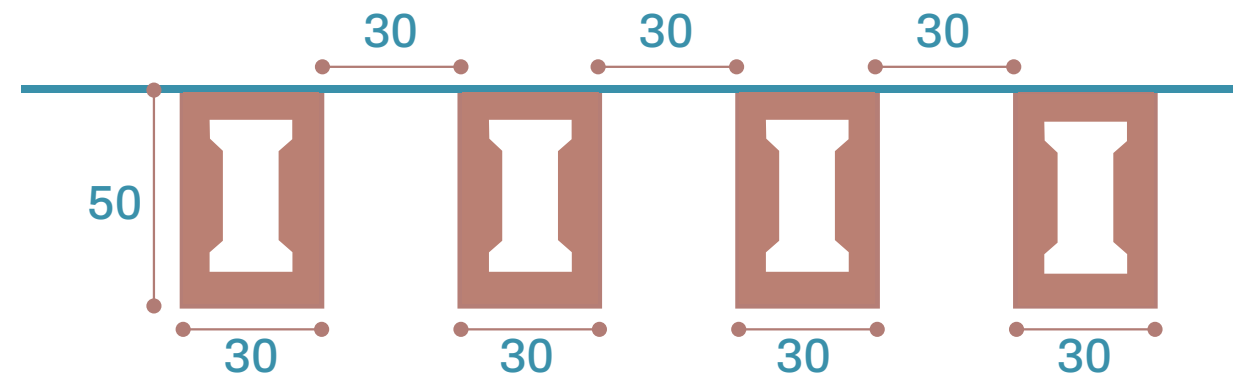

Sugestão 2

R\$ 410,00/M<sup>2</sup>

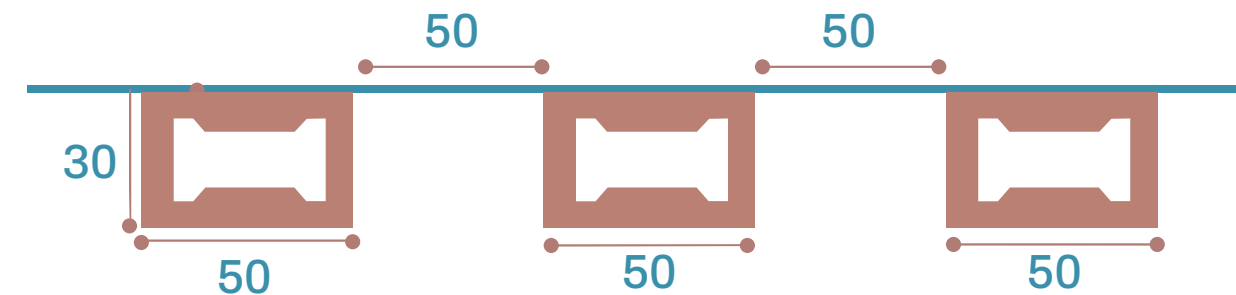

METRO LINEAR A PARTIR DE R\$39

As medidas são sugestivas, e podem variar de acordo com cada projeto.  
Os valores supracitados podem variar de acordo com o espaçamento de cada caso.

Instalação e a estrutura auxillar não inclusa





SEPARAÇÃO DAS PEÇAS



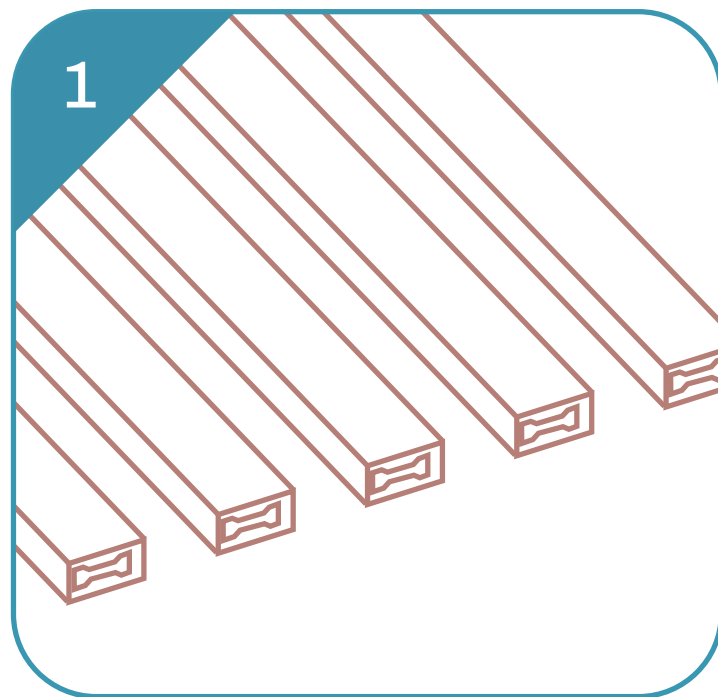

## AJUSTE DA MODULAÇÃO

ALINHAR OS PERFIS DE ACORDO COM A FRENTE / ESPAÇAMENTO PROJETADOS.

O MATERIAL PODE SER TRABALHADO COM QUALQUER MODULAÇÃO.

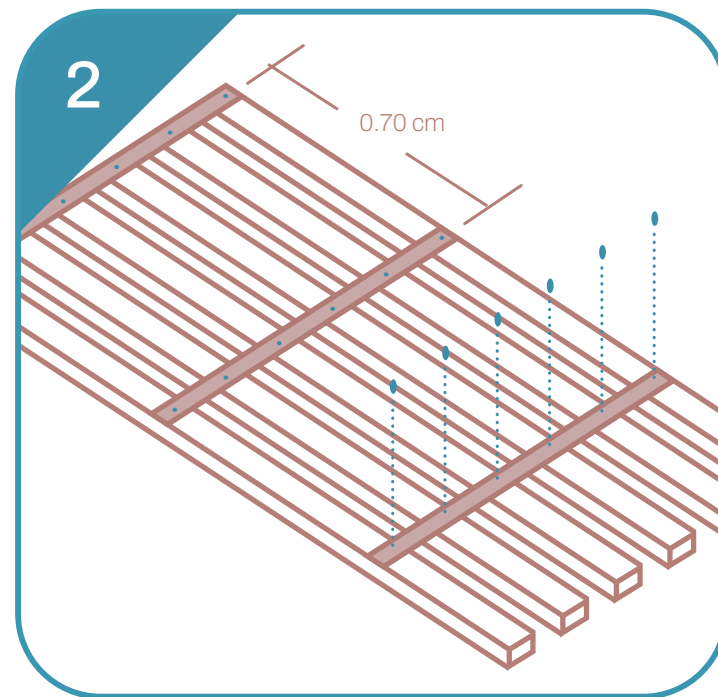

## FIXAÇÃO EM BARRA CHATA METÁLICA

PARAFUSAR OS RIPADOS PELA PARTE DE TRÁS EM UMA BARRA CHATA DE ALUMÍNIO COM 2 PARAFUSOS APLICADOS POR APOIO

O ARKOWOOD K PRECISA DE UMA ESTRUTURA AUXILIAR METÁLICA DE ATÉ 70CM

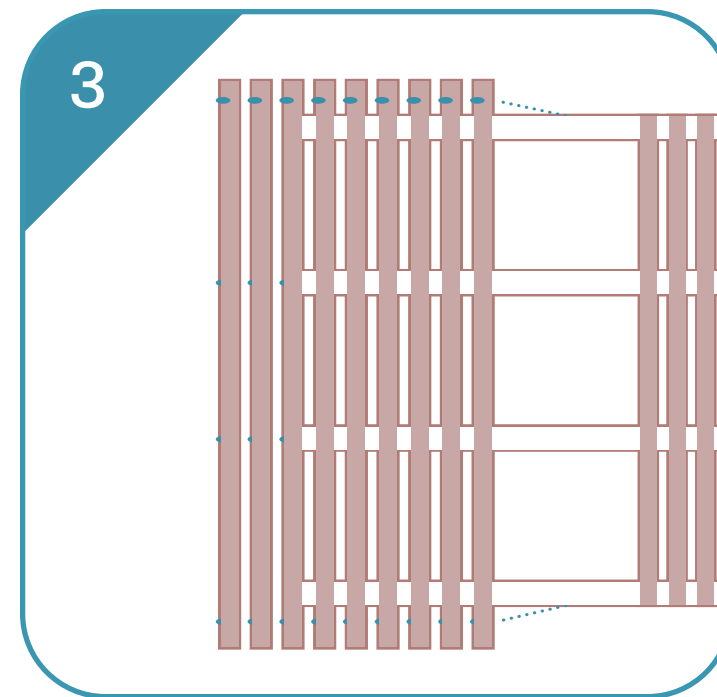

## FIXAÇÃO DA BARRA CHATA NA ESQUADRIA / ALVENARIA

FIXAR A BARRA CHATA COM PARAFUSOS AUTO BROCANTE NA ESTRUTURA METÁLICA.

OS PARAFUSOS DEVEM SER FIXADOS NOS ESPAÇOS ENTRE OS RIPADOS,

PARA FIXAÇÃO DA BARRA CHATA EM ALVENARIAS RECOMENDA-SE O NIVELAMENTO DA SUPERFÍCIE.

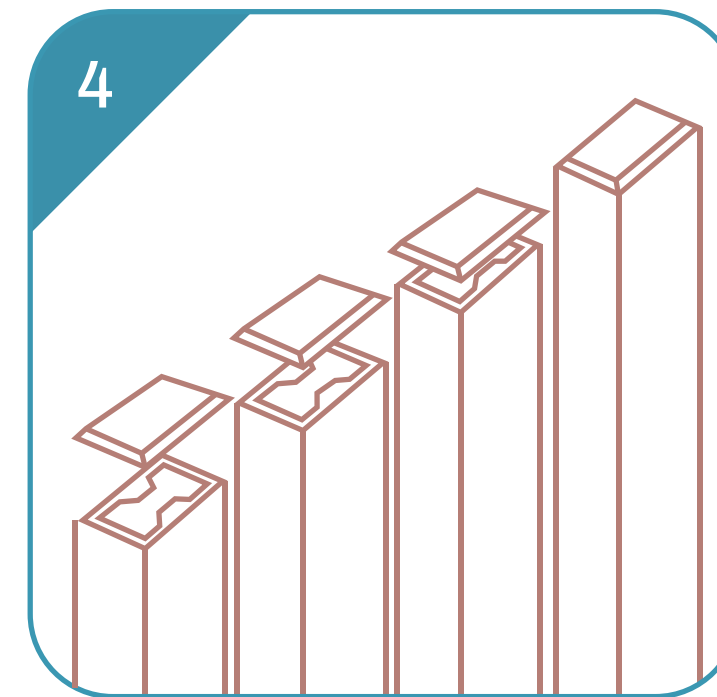

## FIXAÇÃO DE TAMPAS

FIXAR TAMPAS DO ARKOWOOD PARA FECHAMENTO DOS RIPADOS – OPCIONAL

TAMPAS DEVEM SER ORÇADAS A PARTE.

ARKOWOOD K  
FIXAÇÃO

*Instalação e estrutura  
auxiliar não estão inclusas*



# ARKWOOD K



1 AJUSTE DA MODULAÇÃO



2 FIXAÇÃO EM BARRA CHATA METÁLICA



3 FIXAÇÃO NA ESQUADRIA / ALVENARIA



4 FIXAÇÃO DE TAMPAS COM DRENOS PARA VENTILAÇÃO



# ARKWOOD K

## INSTALAÇÃO HORIZONTAL

SUPERFÍCIE DE APOIO

SUB-ESTRUTURA

SUB-ESTRUTURA :

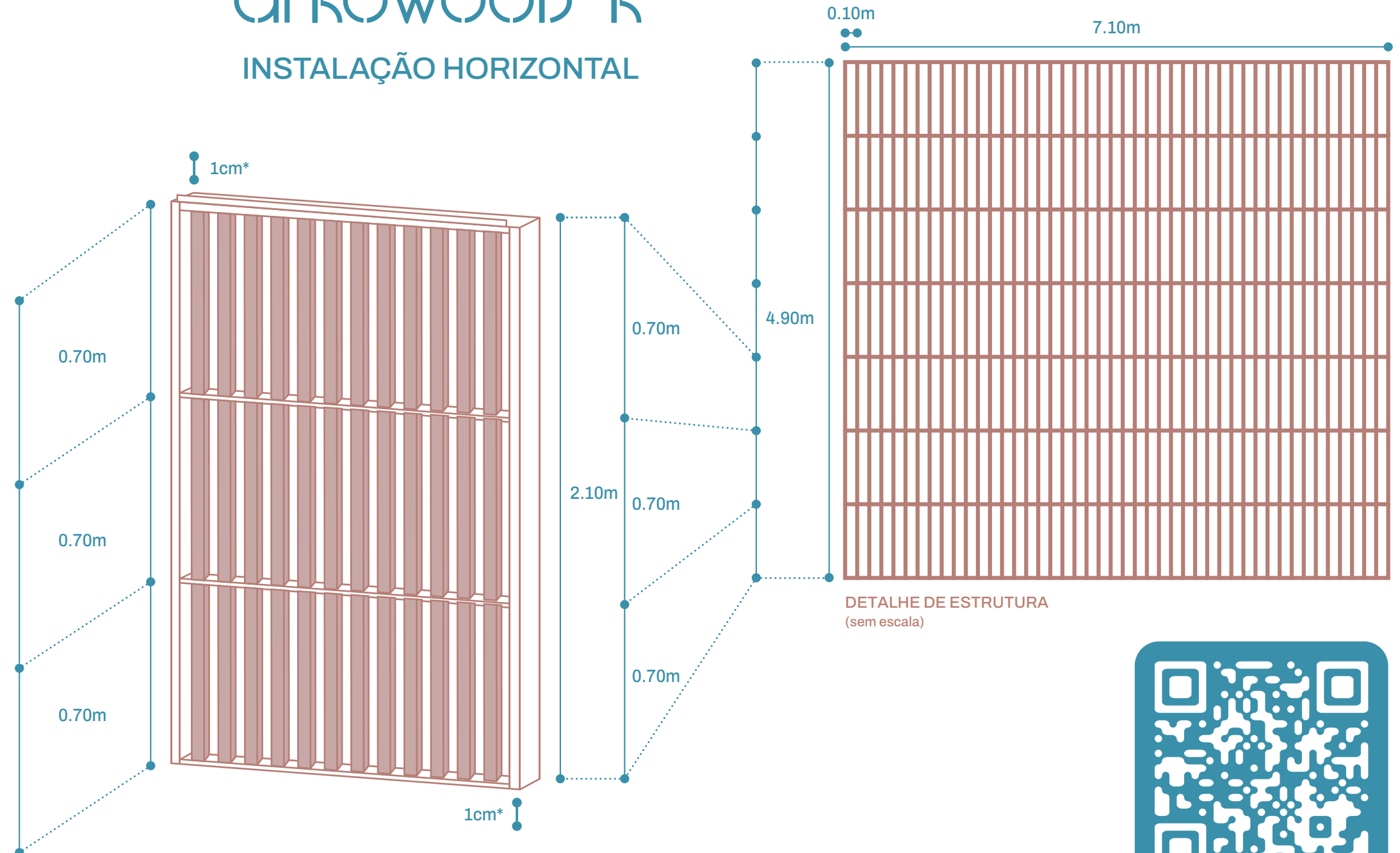

\*manter espaçamento de 1cm no topo e na parte inferior para ventilação e dilatação do material

Video de instalação:





# ARKWOOD K

## INSTALAÇÃO VERTICAL

SUPERFÍCIE DE APOIO



SUB-ESTRUTURA



SUB-ESTRUTURA :

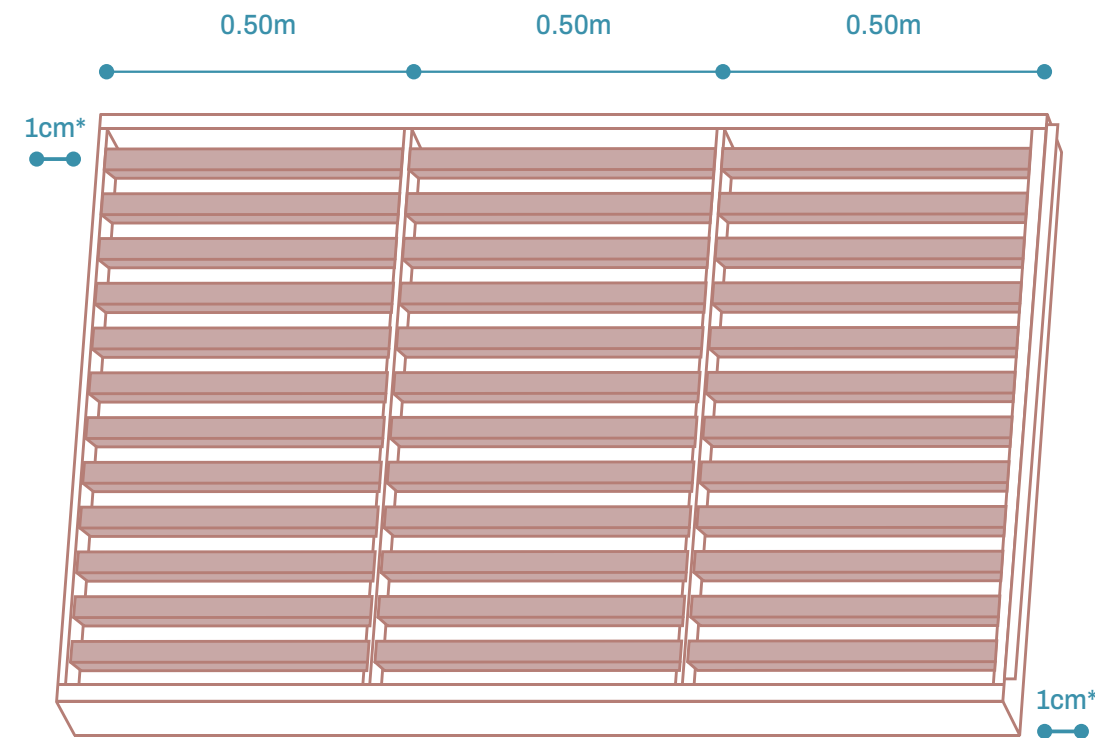

\*manter espaçamento de 1cm nas laterais para ventilação e dilatação do material

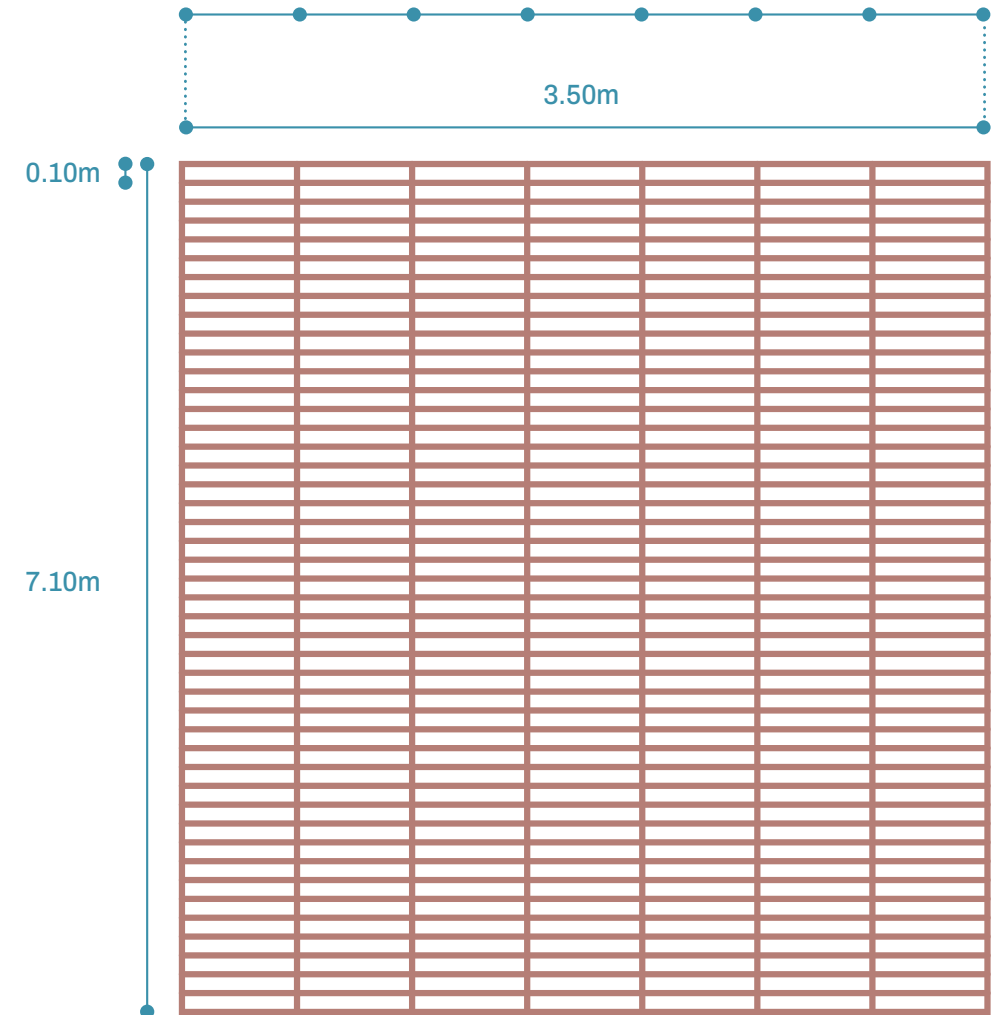

DETALHE DE ESTRUTURA  
(sem escala)

Video de  
instalação:





# ARKOWOOD K

## SISTEMA DE FIXAÇÃO

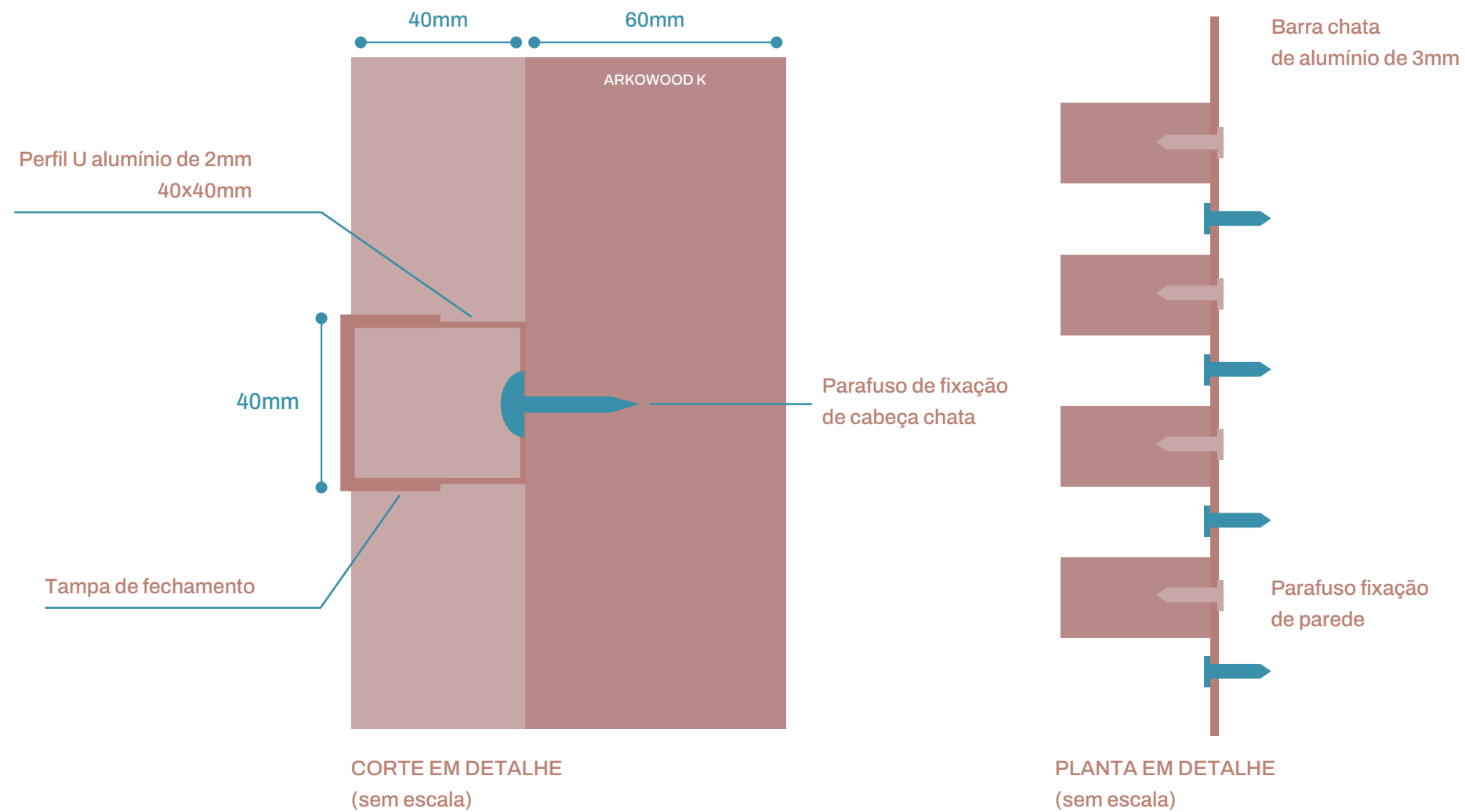

Para a fixação, faça um furo circular no produto com uma broca de diâmetro maior que o do parafuso, de 1 a 2 mm. Após a realização do furo, faça a fixação com os parafusos.





FIXAÇÃO DAS PEÇAS



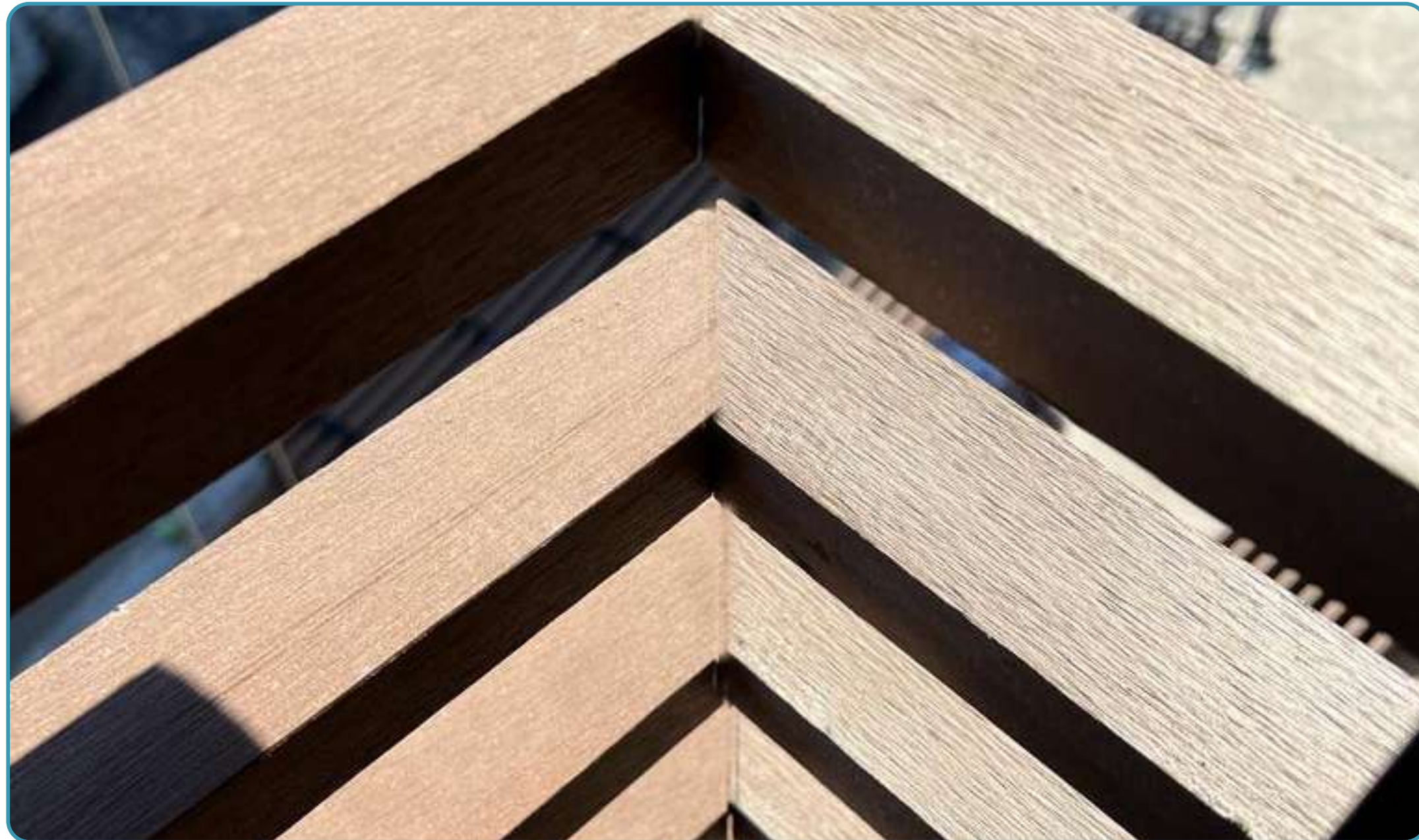

# arkowood K

DETALHES - ENCONTROS

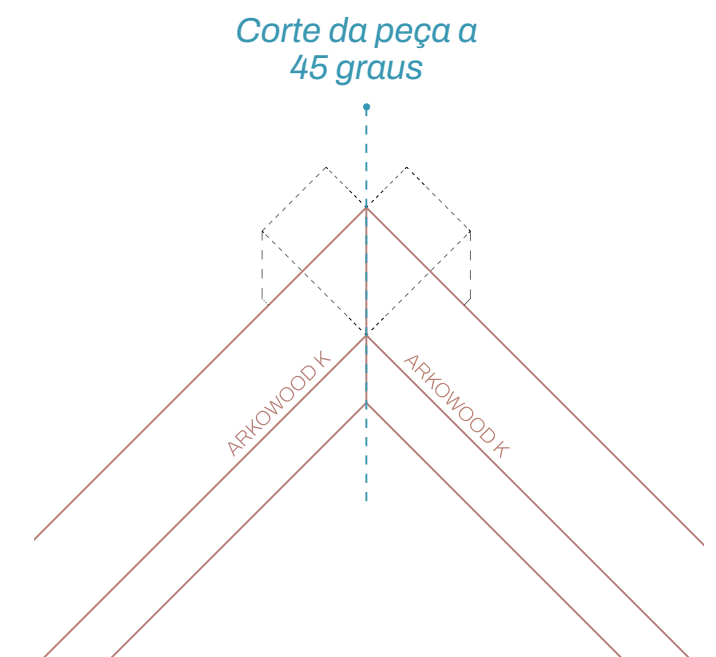



# arkowood K

REFORÇO ESTRUTURAL



*Perfil metálico interno fixado nas extremidades da esquadria ou alvenaria*

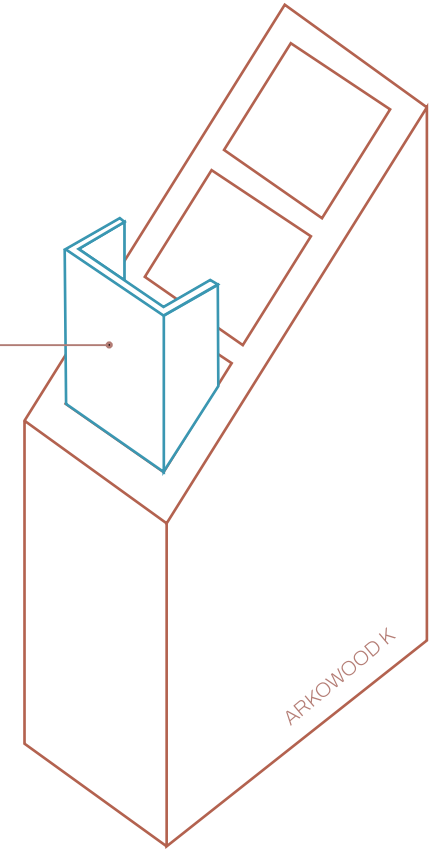



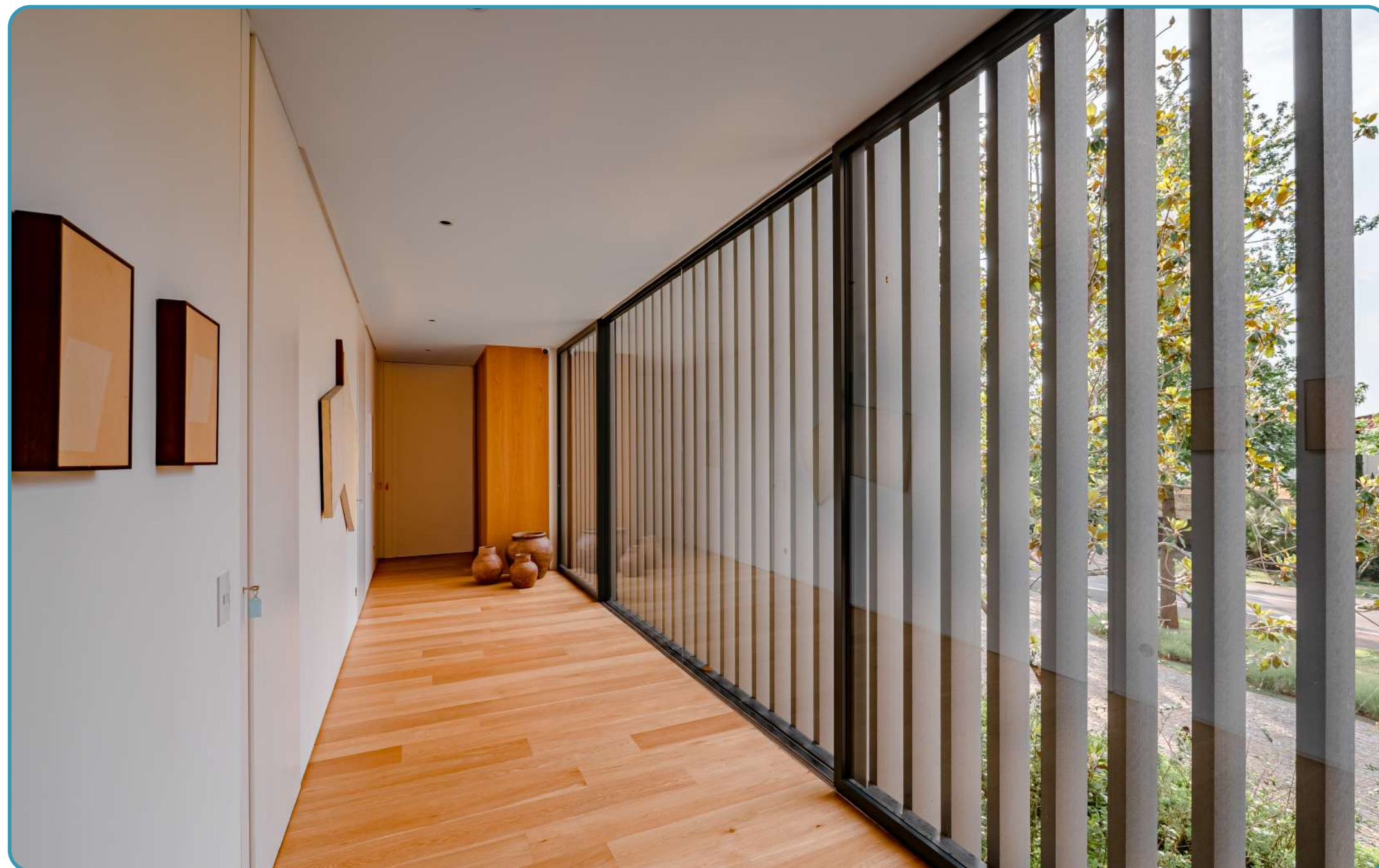

arkWOOD K

REFORÇO ESTRUTURAL



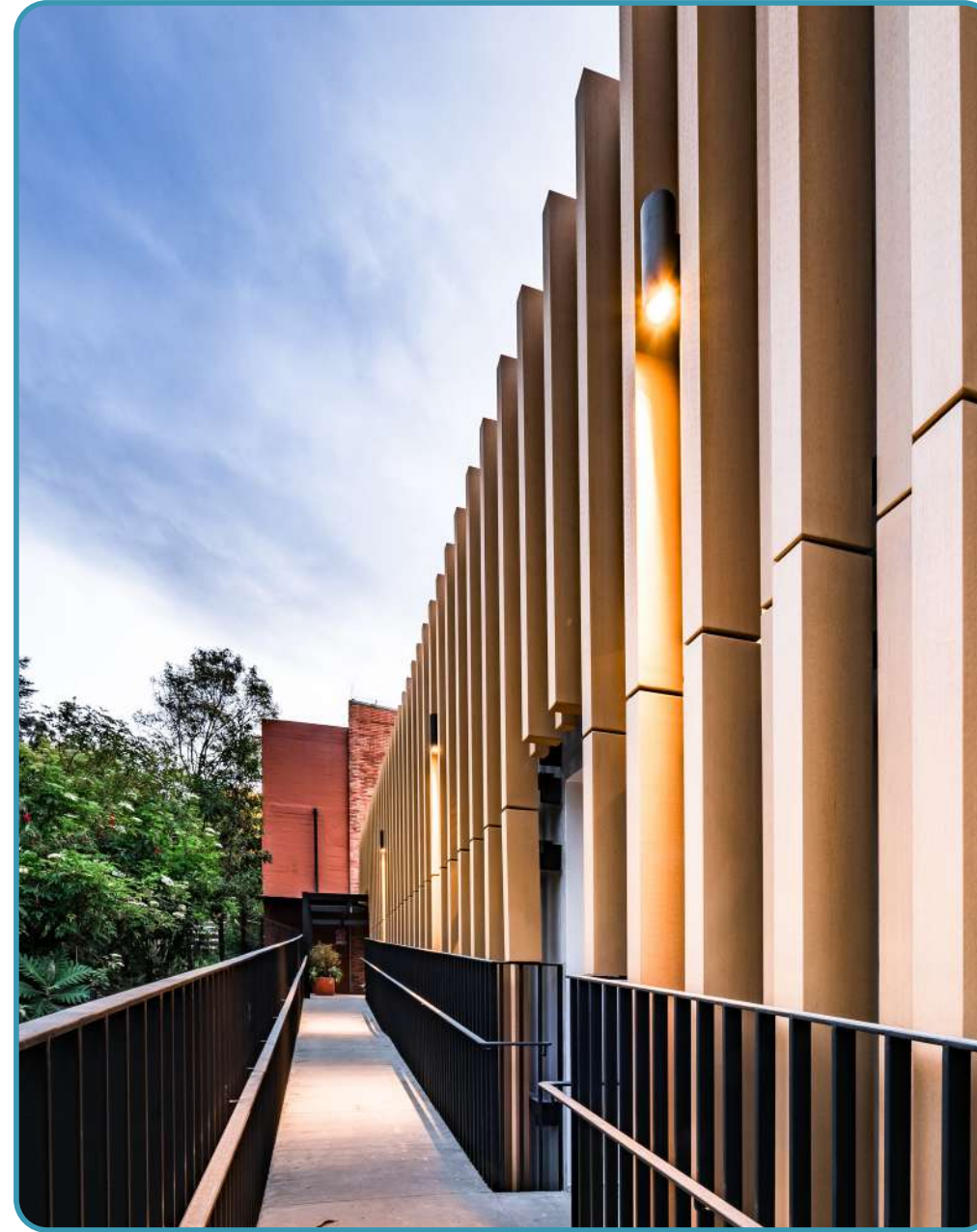
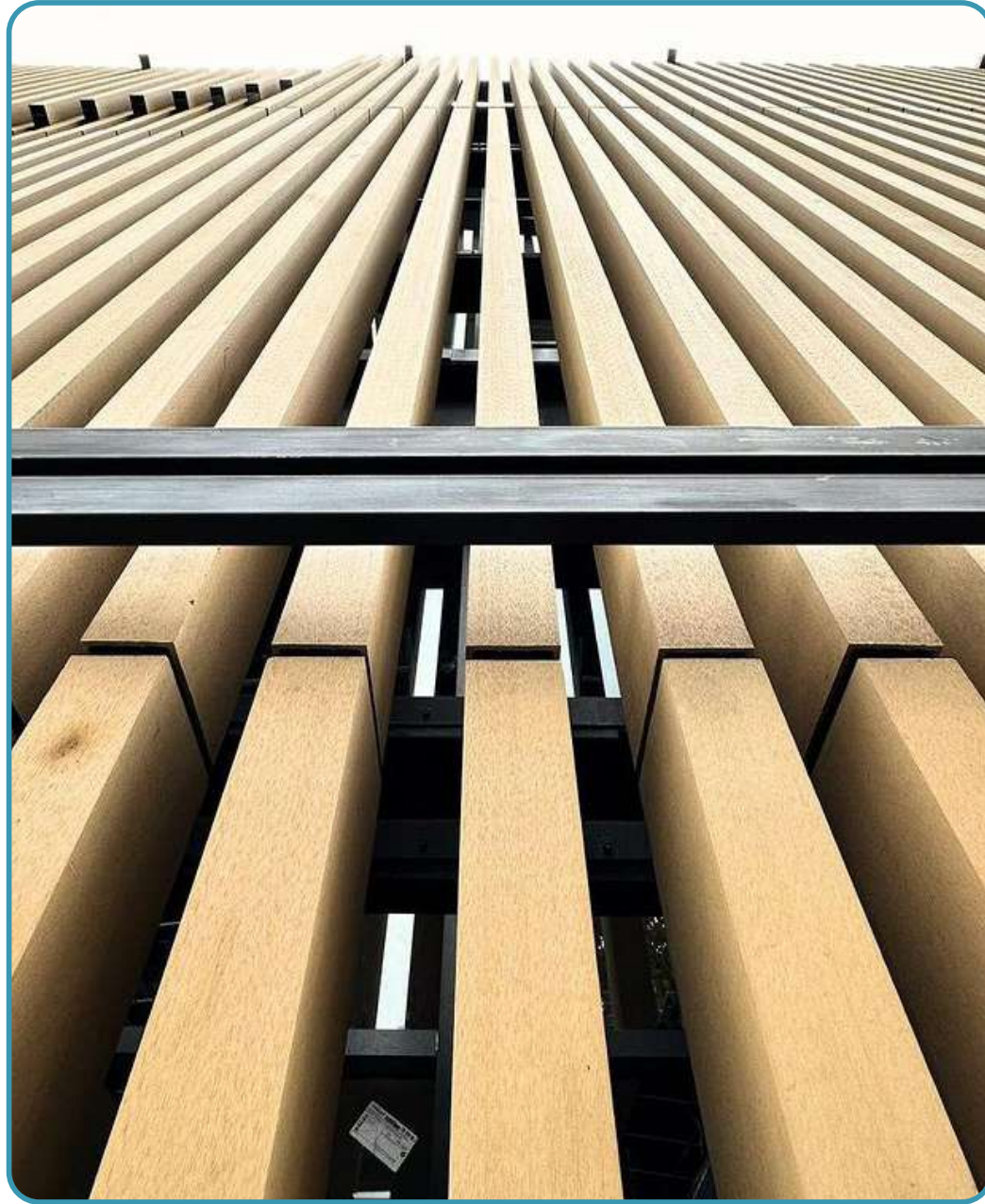

# arkwood K

## JUNTAS

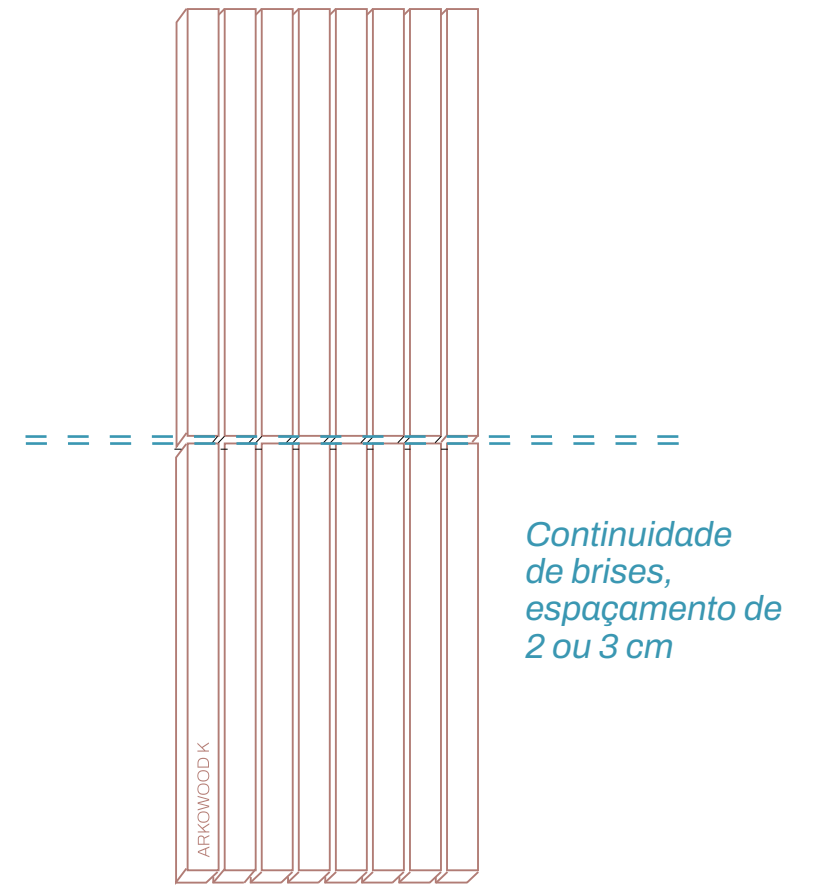

*Continuidade de brises,  
espaçamento de  
2 ou 3 cm*



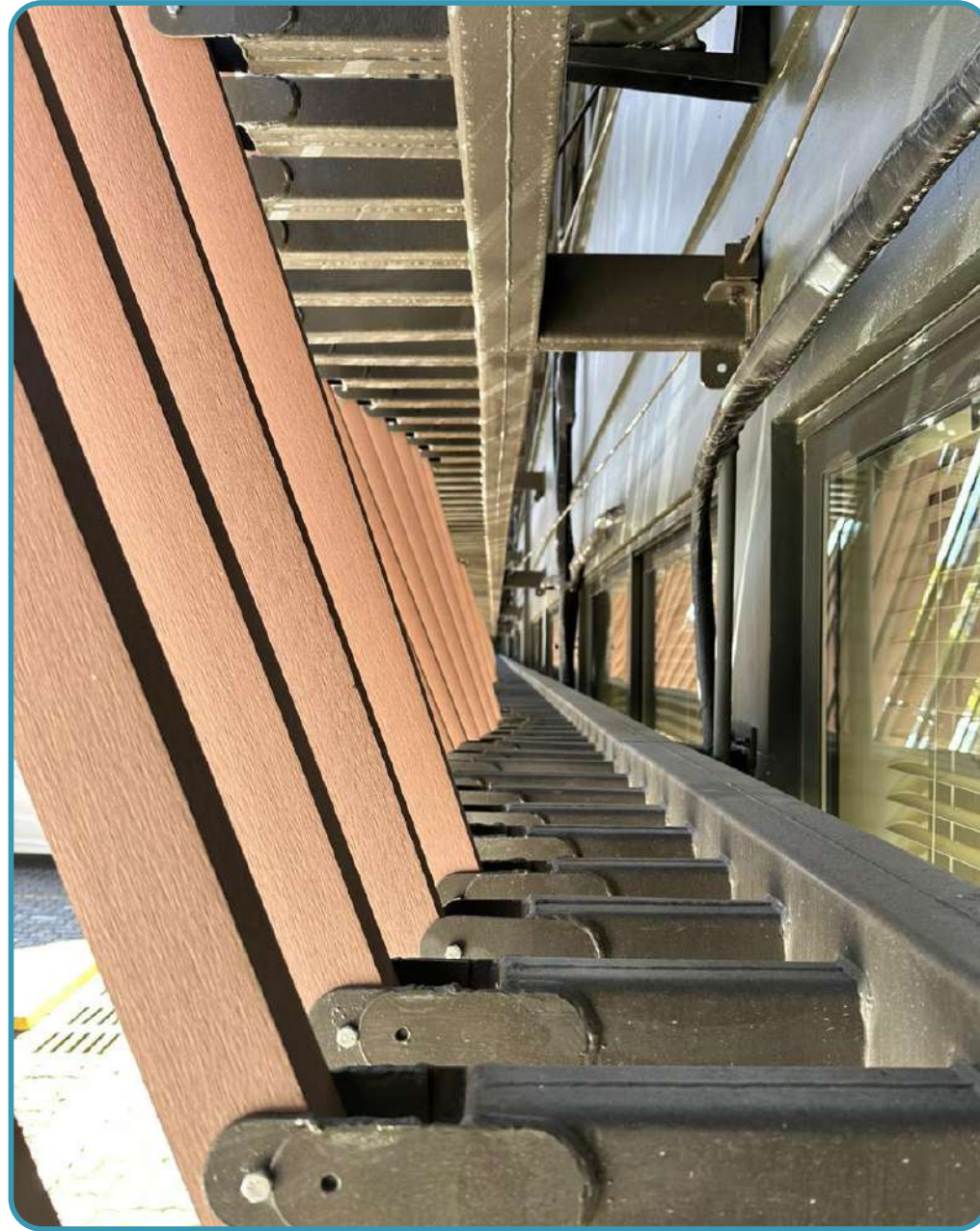
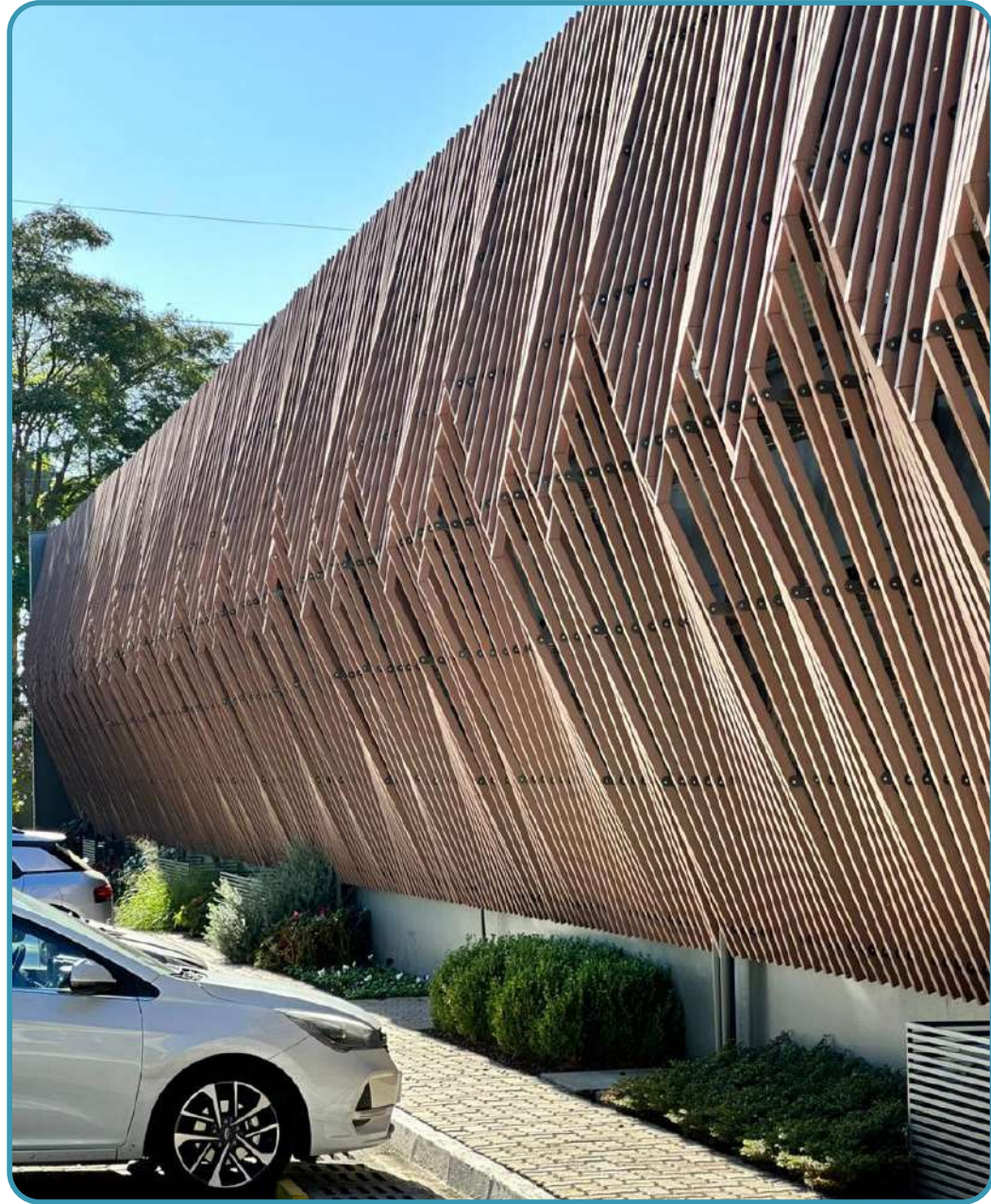

# arkWOOD K

APLICAÇÕES DIFERENCIADAS

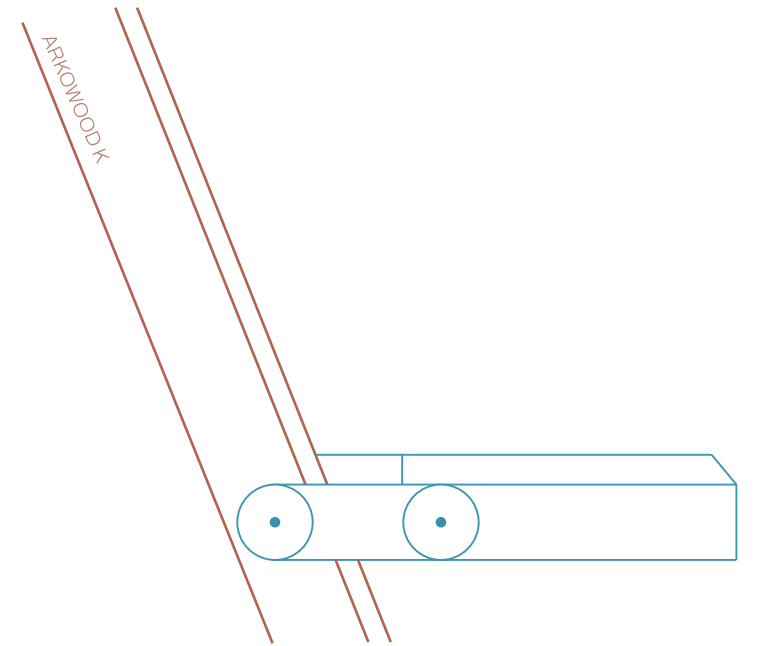



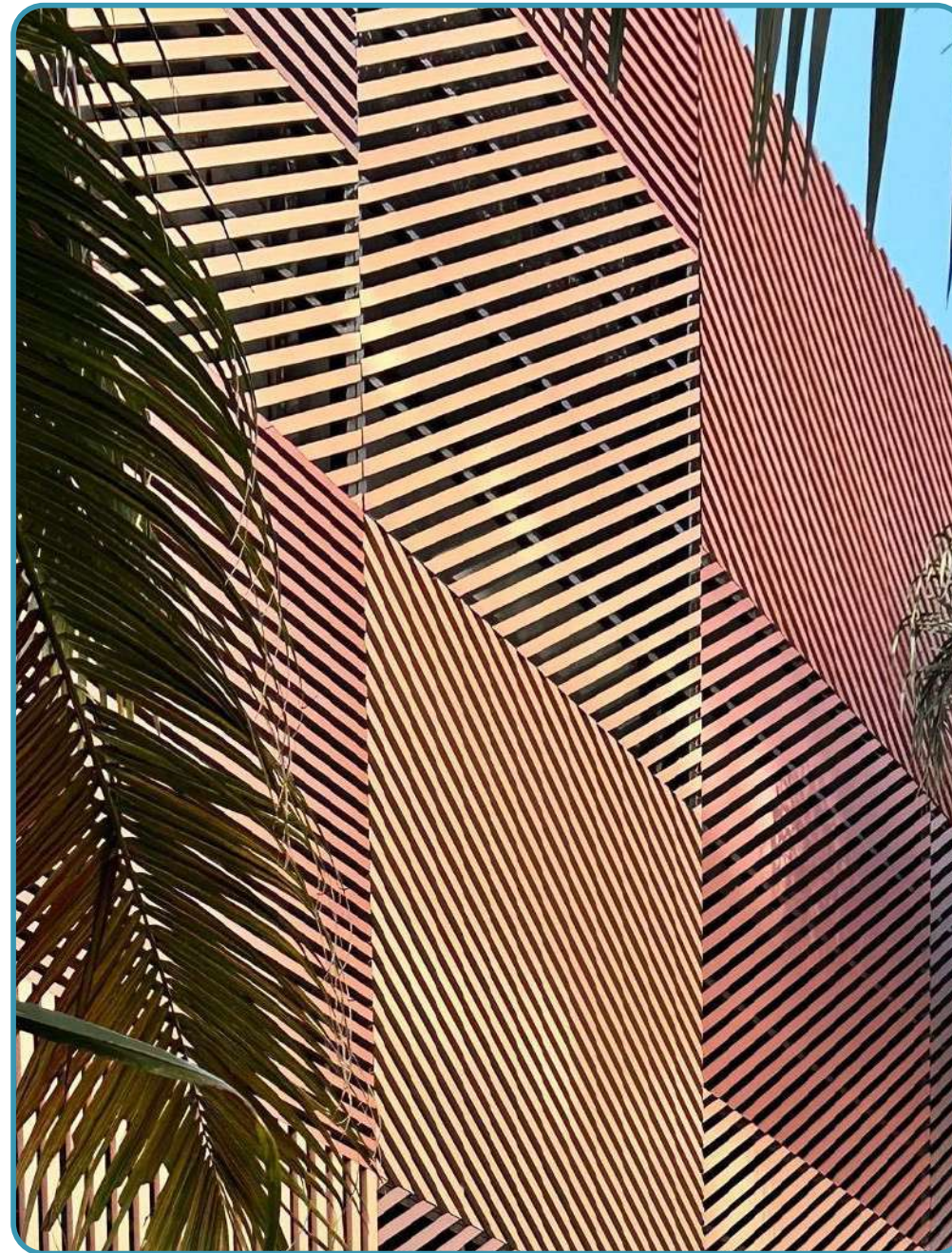
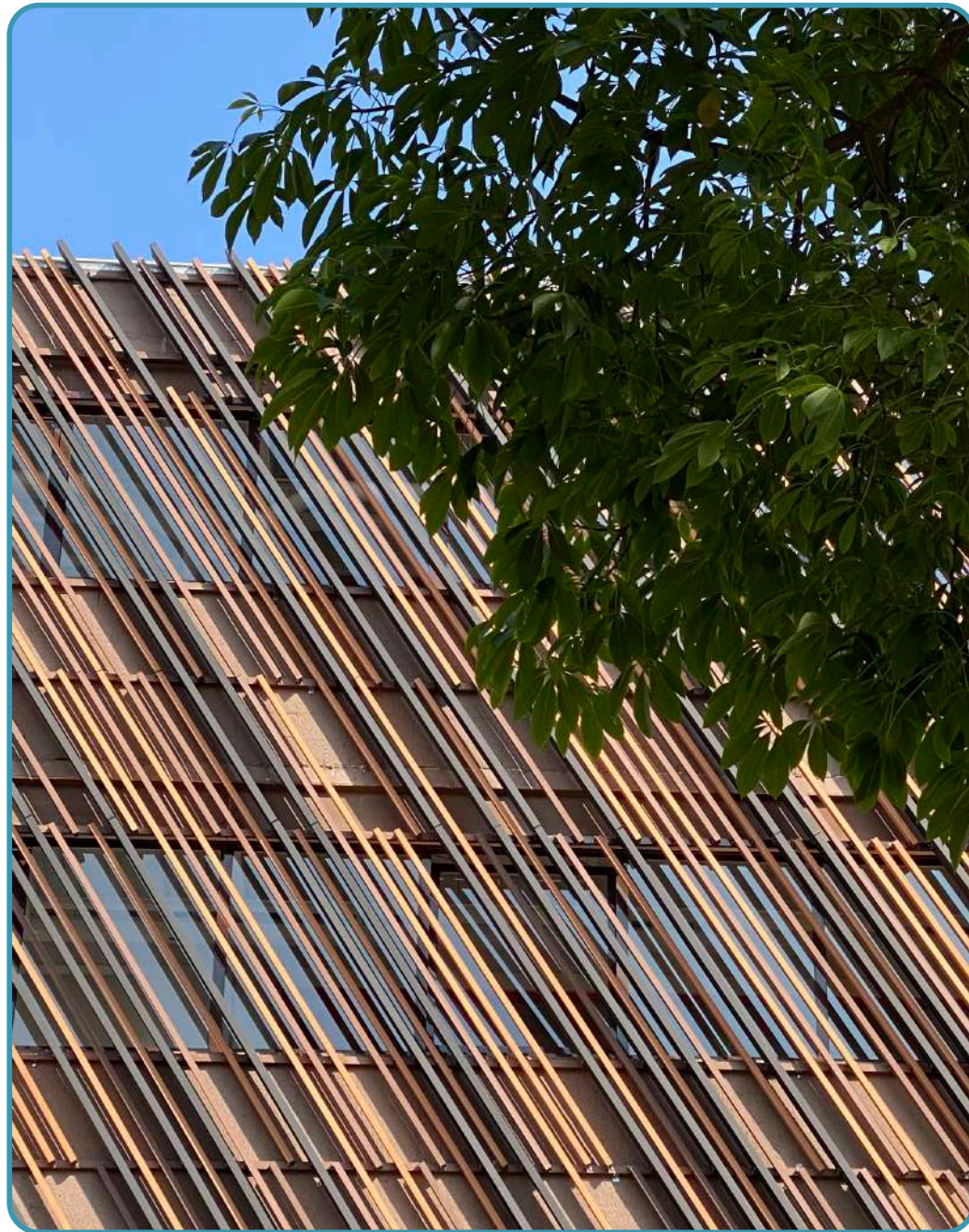

# arkWOOD K

COMBINAÇÃO DE SEÇÕES

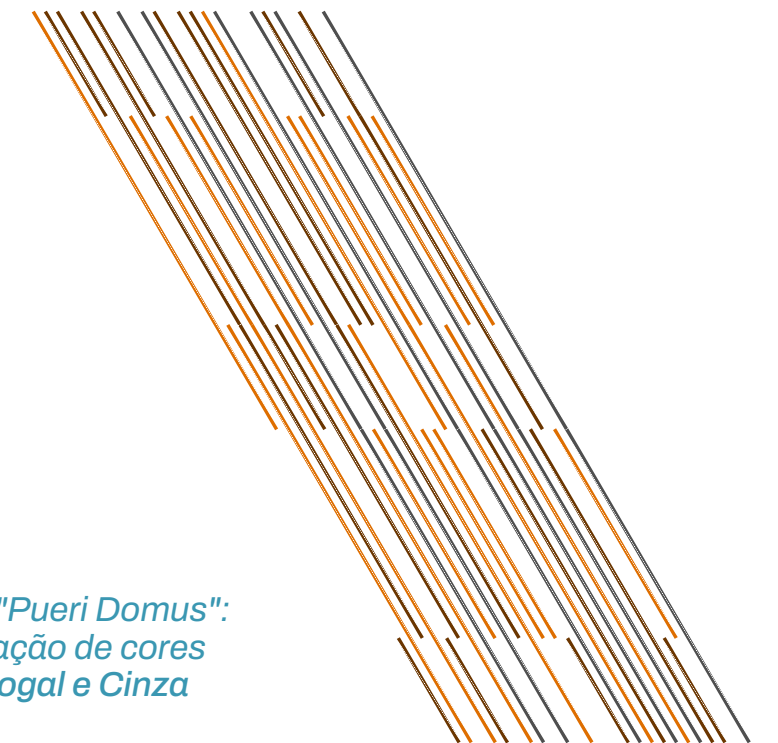

*Projeto "Pueri Domus":  
combinação de cores  
Teka, Nogal e Cinza*



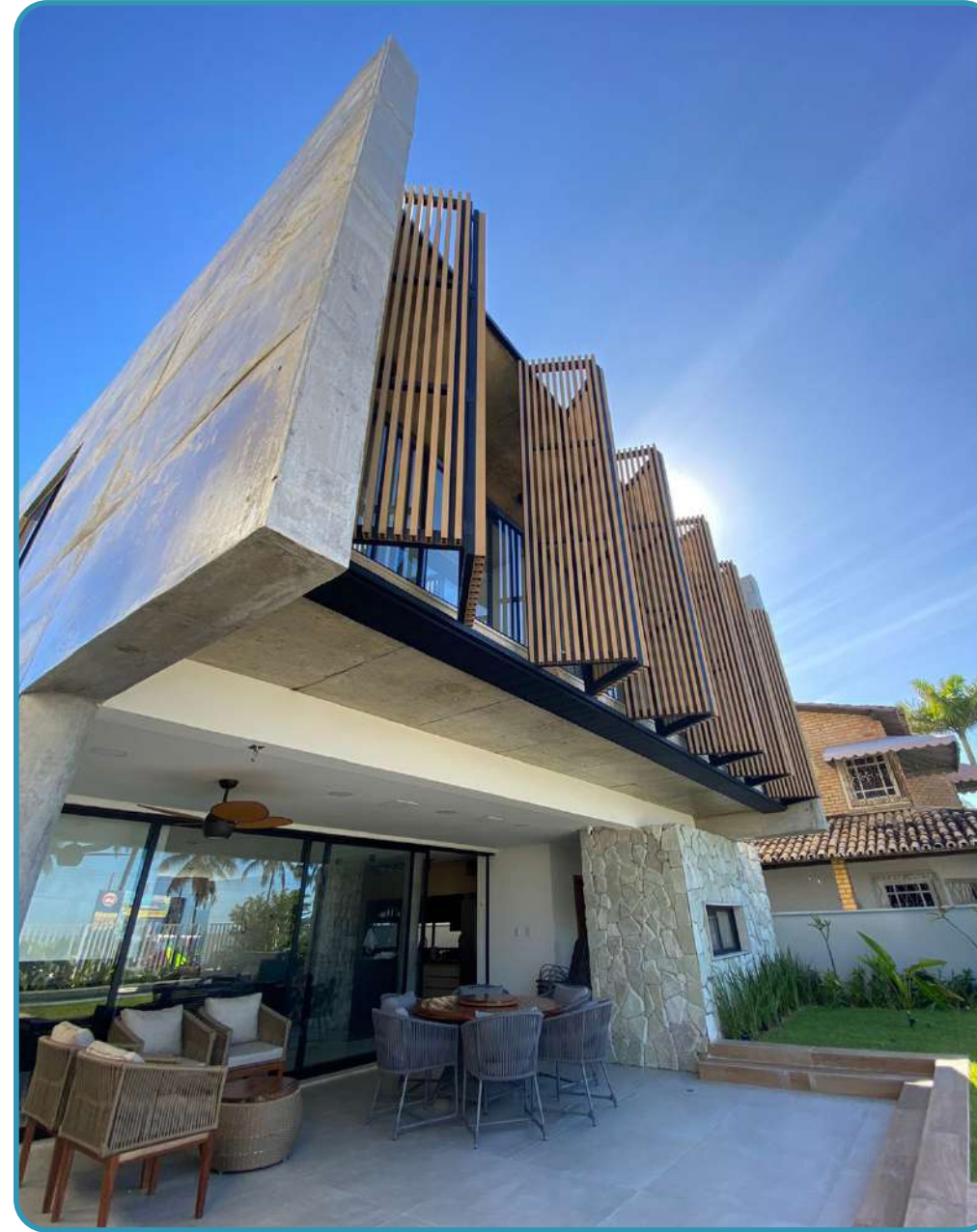
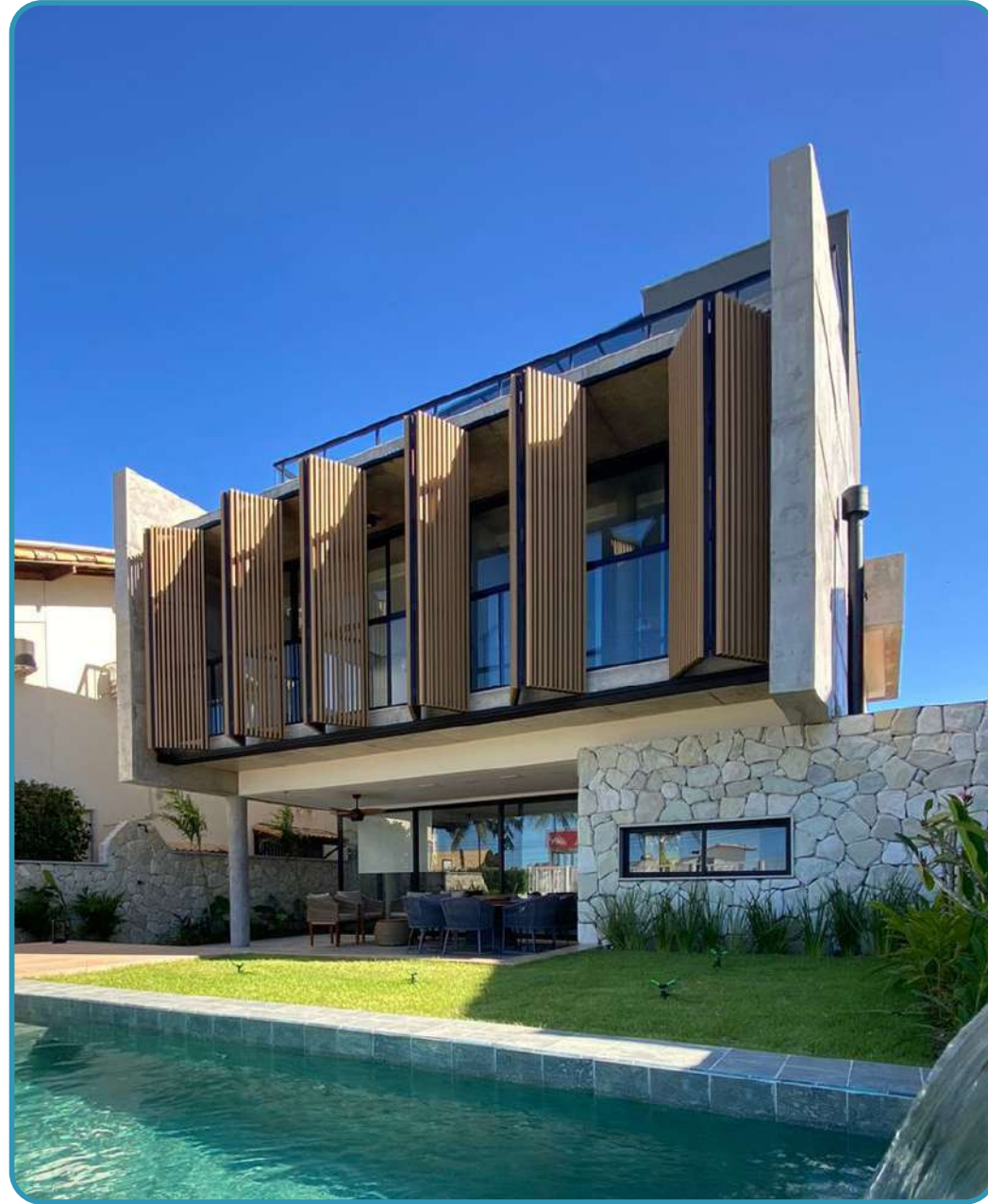

# arkWOOD K

PORTAS E JANELAS CAMARÃO

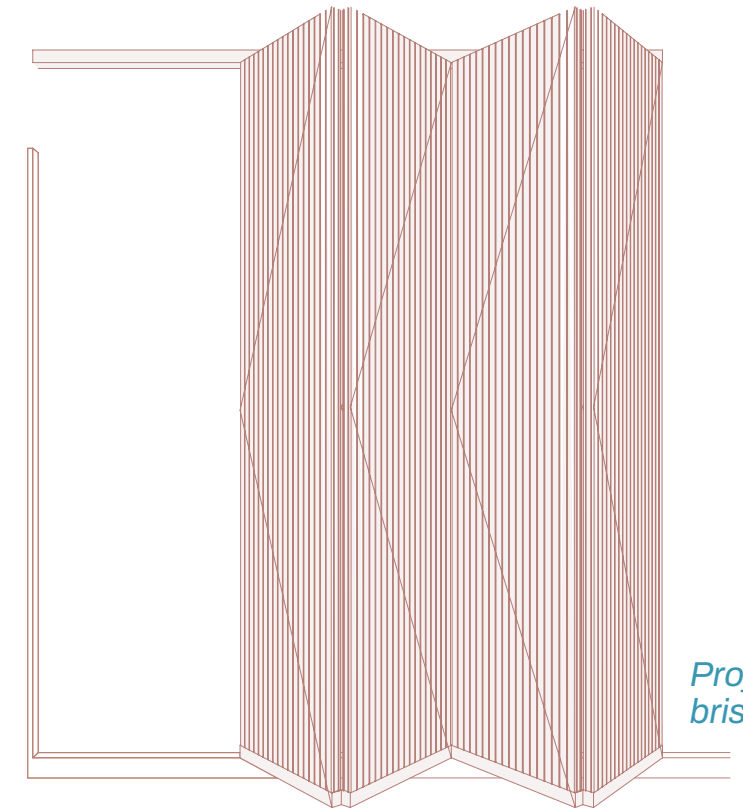

*Projeto com  
brises frontais*



# arkWOOD K

ACESSÓRIOS

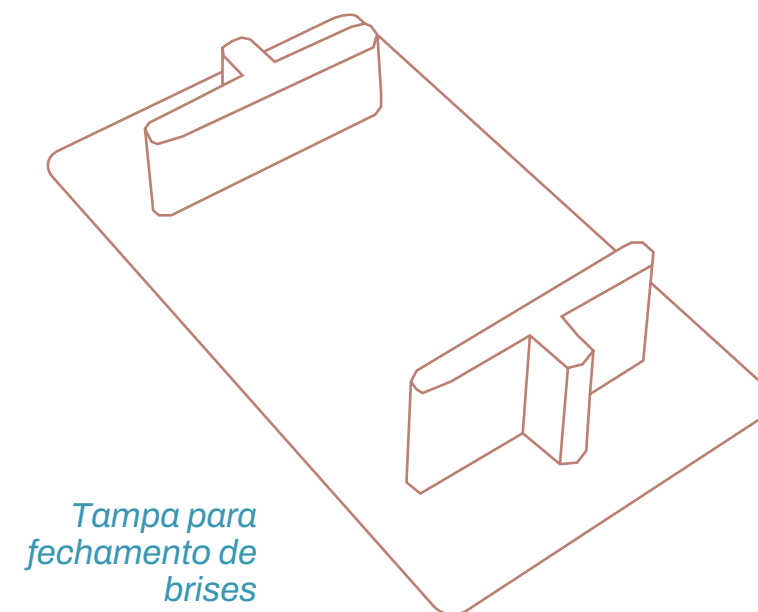

*Tampa para  
fechamento de  
brises*



# arkWOOD K

FERRAMENTAS DE INSTALAÇÃO



CORTADOR DE DISCO CIRCULAR



DISCO CIRCULAR PARA MADEIRA



PARAFUSADEIRA COM PARAFUSO  
PERFURANTE DE CABEÇA CHATA



# ARKOWOOD K

---

## RECOMENDAÇÕES DE USO E MANUTENÇÃO

Não bata no material durante a descarga e segure-o muito bem durante o transporte, armazene o produto em paletes ou bases firmes, uniformes e rígidas, não exceda 40 unidades na vertical ao empilhar e não descanse elementos pesados sobre o produto armazenado.

Proteja-o dos elementos com materiais não translúcidos: polietileno preto, papelão ou materiais similares, garantindo fluxo contínuo de ar. Se houver contaminação, limpe imediatamente removendo qualquer substância derramada, não utilize produtos abrasivos e não esfregue, molhe-o com água quente e seque com um pano macio. Pode ser lavado à pressão, com uma recomendação de pressão máxima de 1100 PSI, sempre adote as medidas de segurança necessárias e evite danos ao material.



**AMANTES DE BOA ARQUITETURA**



arkos



[www.arkosbrasil.com.br](http://www.arkosbrasil.com.br)

 arkosbrasil



 +5511971196692