

arkos

arkowood P

REVESTIMENTOS DE DISTINTAS MORFOLOGIAS
DE MADEIRA ECOLÓGICA PARA INTERIORES



Características

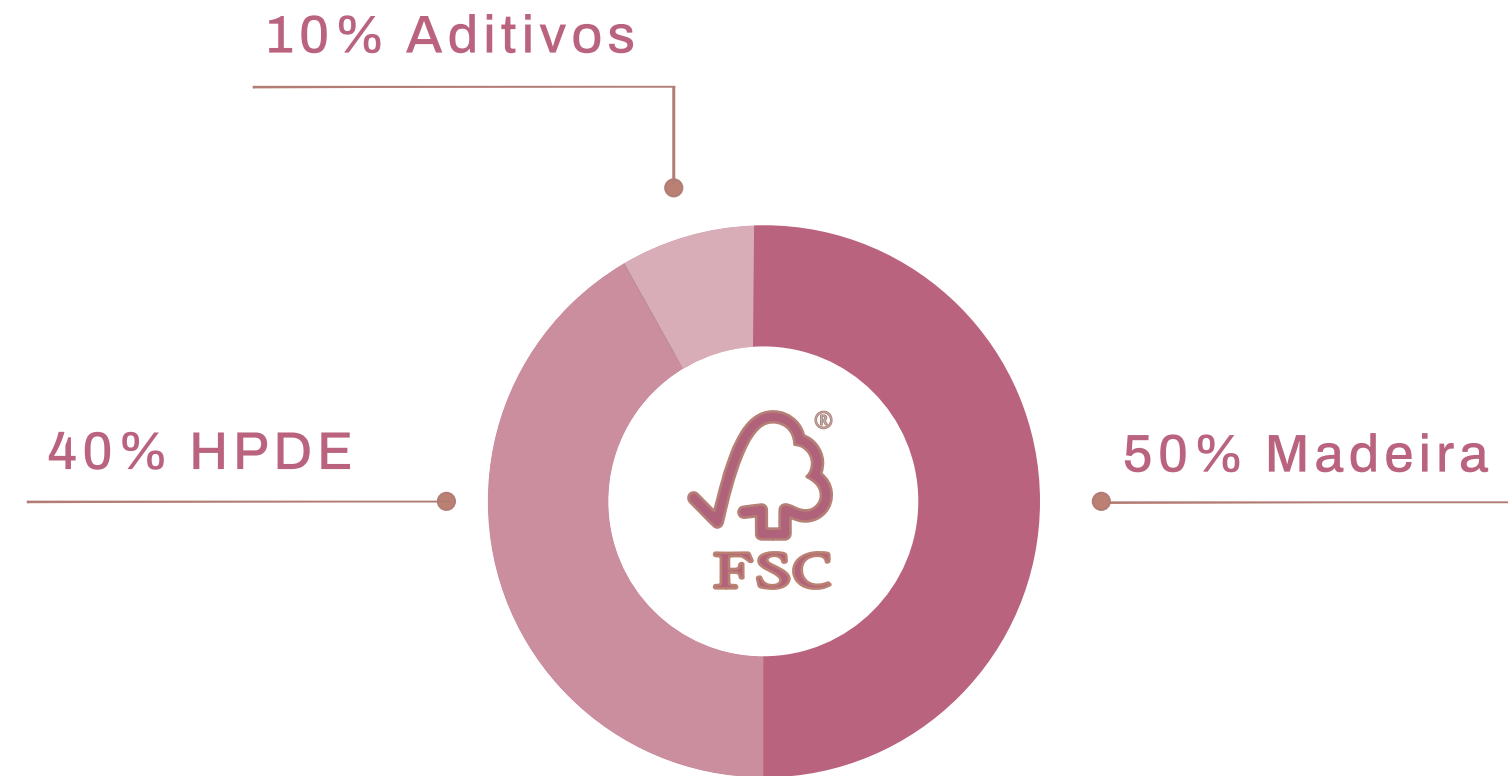

Revestimentos de distintas geometrias e acabamentos, compostos de madeira ecológica, HDPE e aditivos, certificado pelo selo FSC de responsabilidade ambiental, desenhados para aplicação em **áreas internas**.



Características

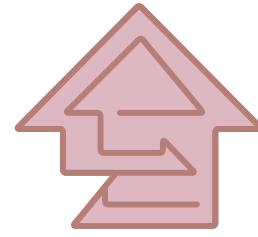

Alta durabilidade

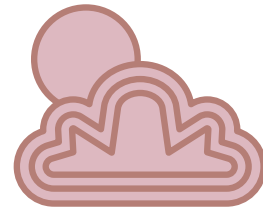

Aplicável em qualquer tipo de
clima e região

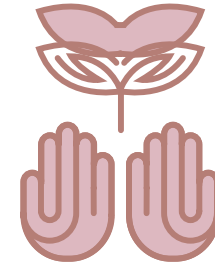

Responsabilidade com
o meio ambiente

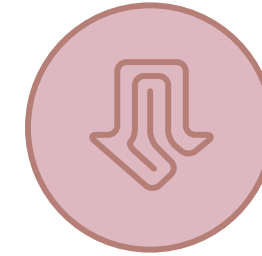

Fácil instalação

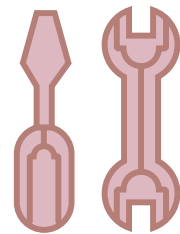

Não requer manutenção

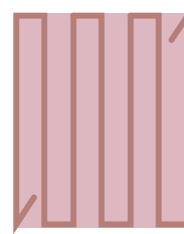

Material leve

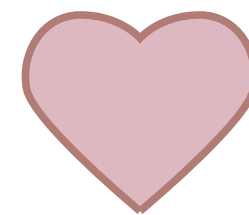

Vida útil de mais de
20 anos

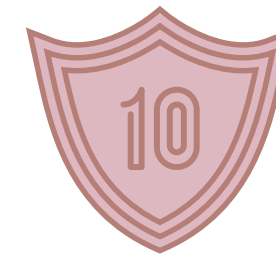

Garantia de 10 anos

Dimensões

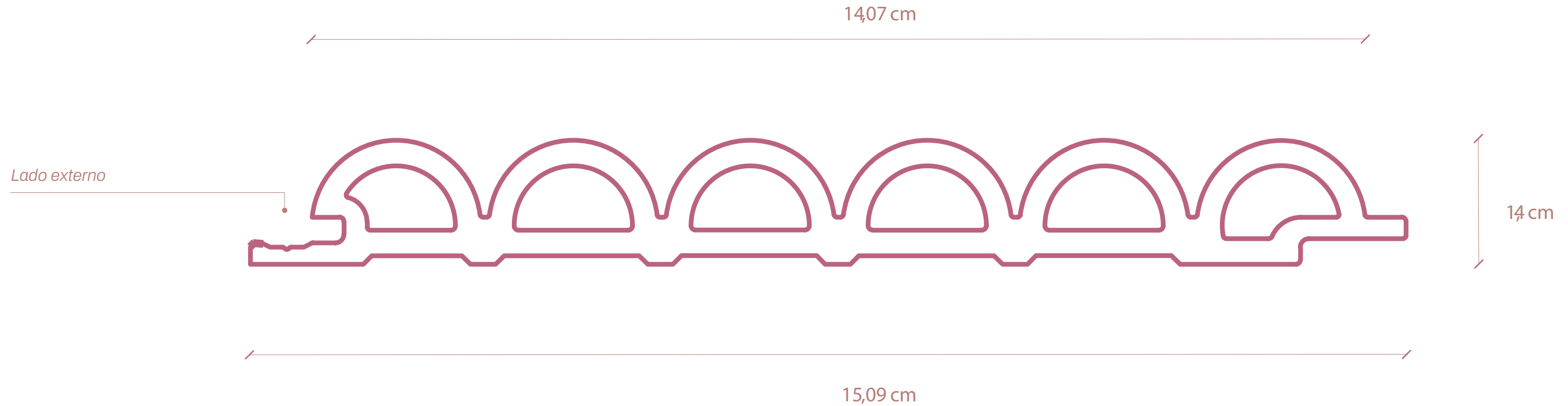

R\$430/M²

Comprimento entre 2,90m a 4,00m

ARKWOOD P

ARKWOOD PB

PALETA DE CORES

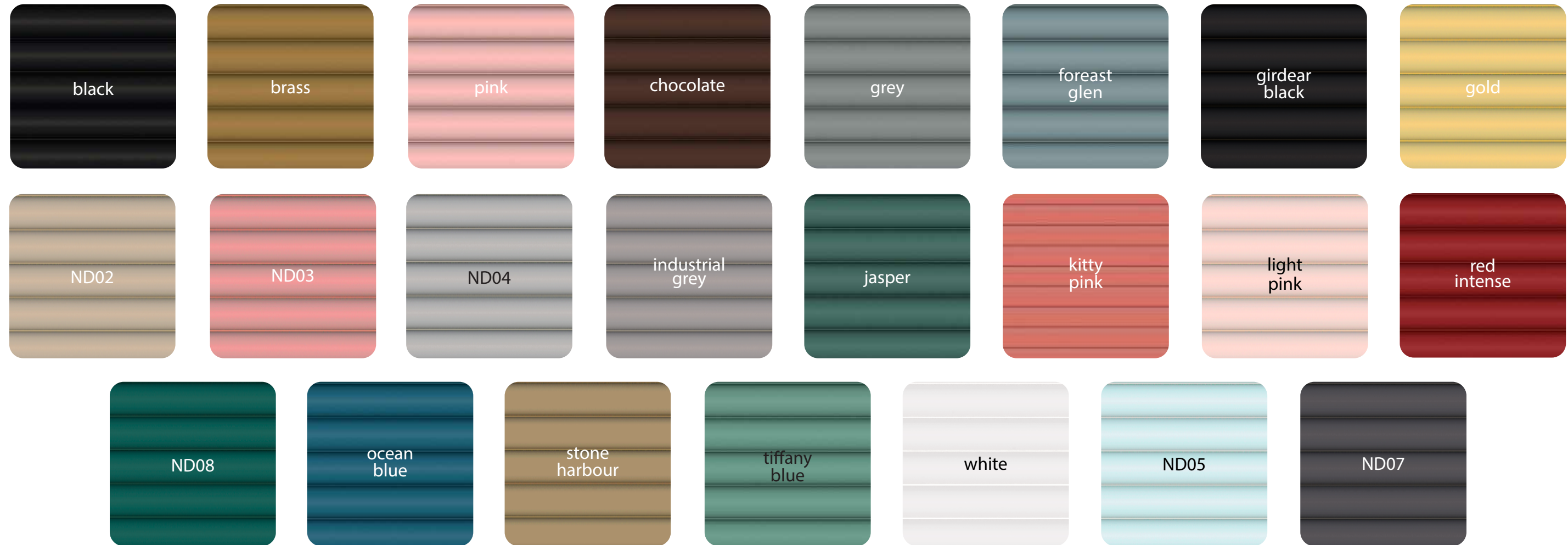

arkos

*CORES ESPECIAIS SOB ENCOMENDA
A PARTIR DE 60 METROS QUADRADOS

ARKWOOD PB

PROJETOS



Showroom Mari Maria - Oficina de Projetos (OP)

ARKWOOD PB PINK

São Paulo, SP



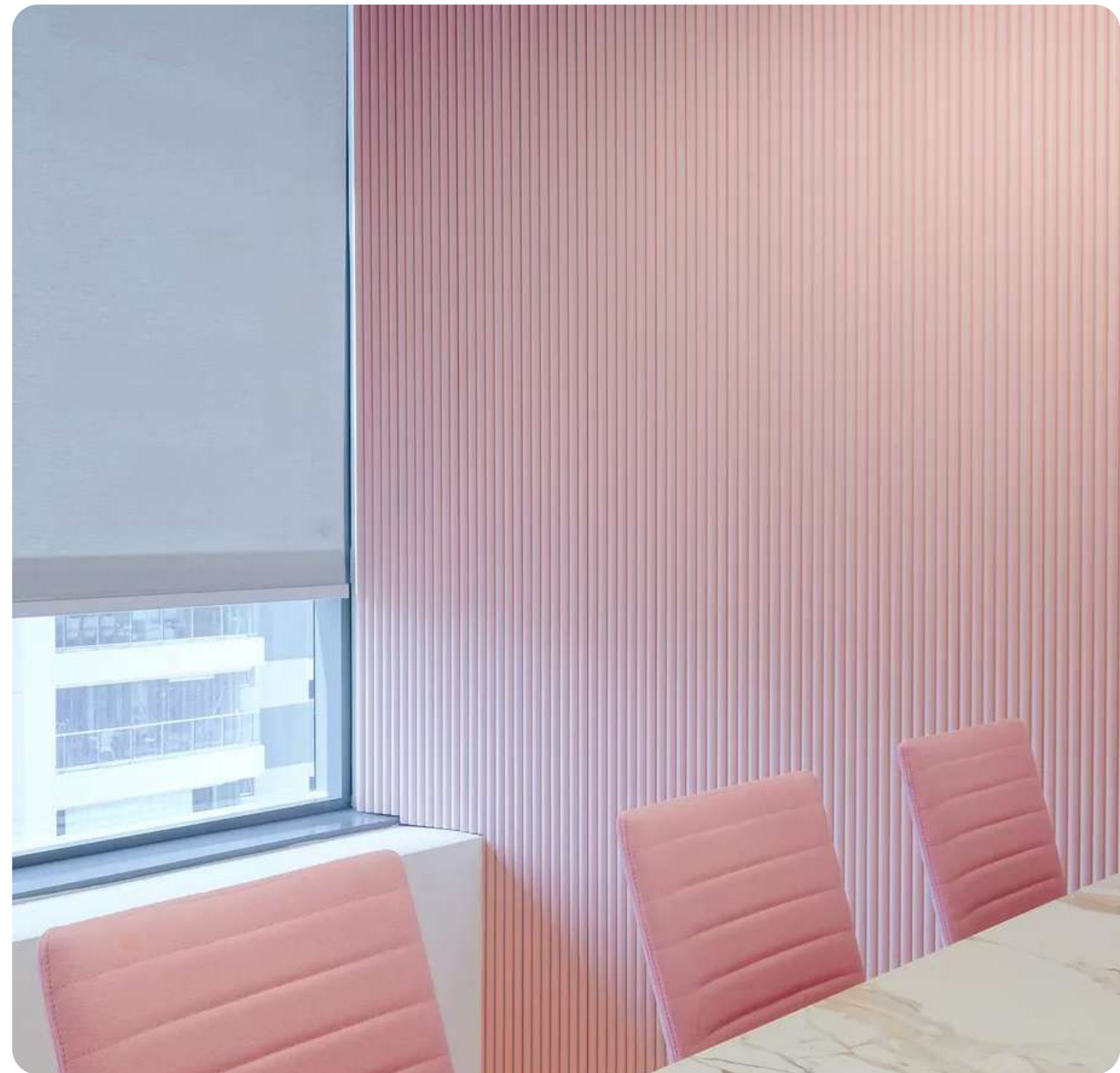



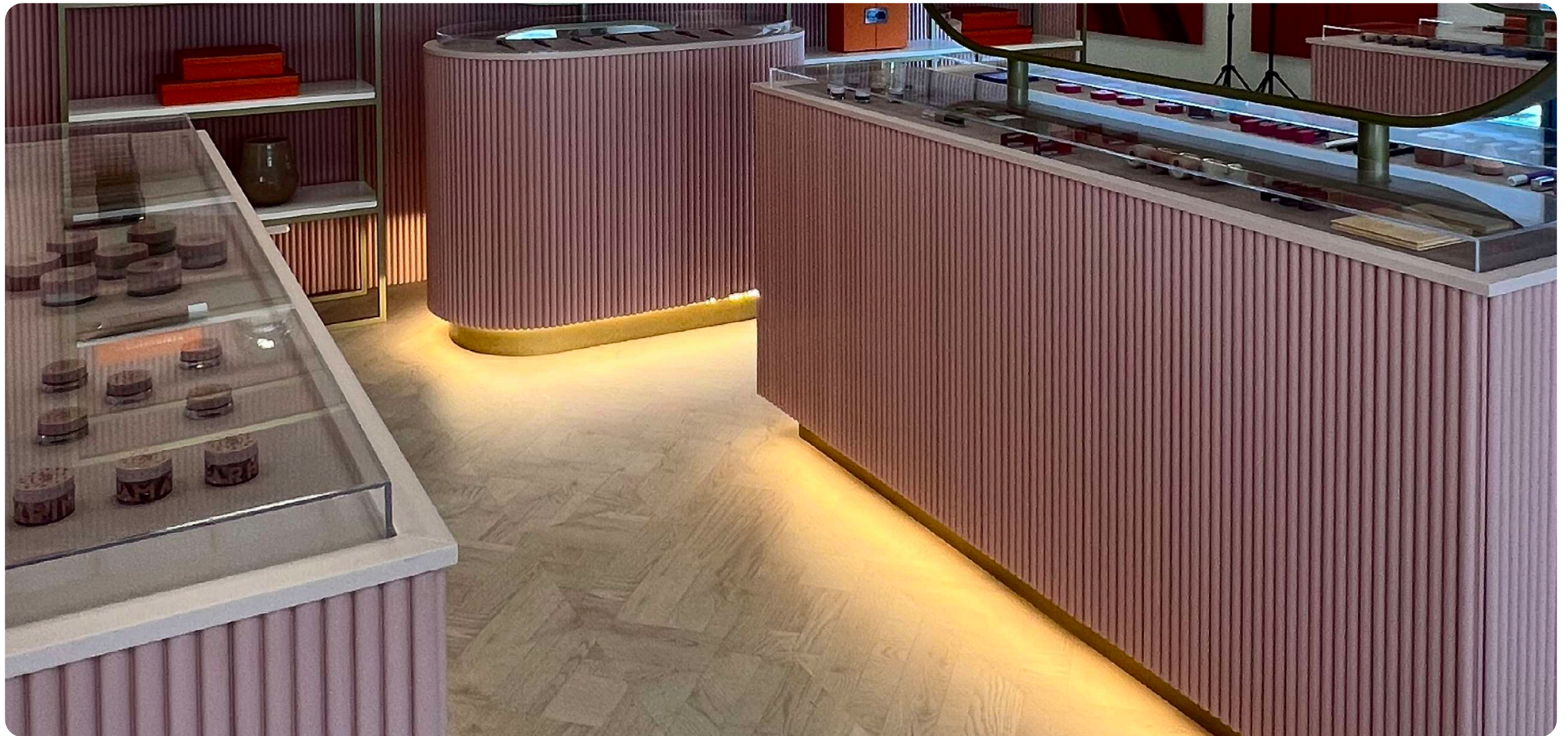



Casa Cor Santa Catarina - Giusti Mercadante Arquitetura

ARKWOOD PB PINK+BLACK

Florianópolis, Santa Catarina











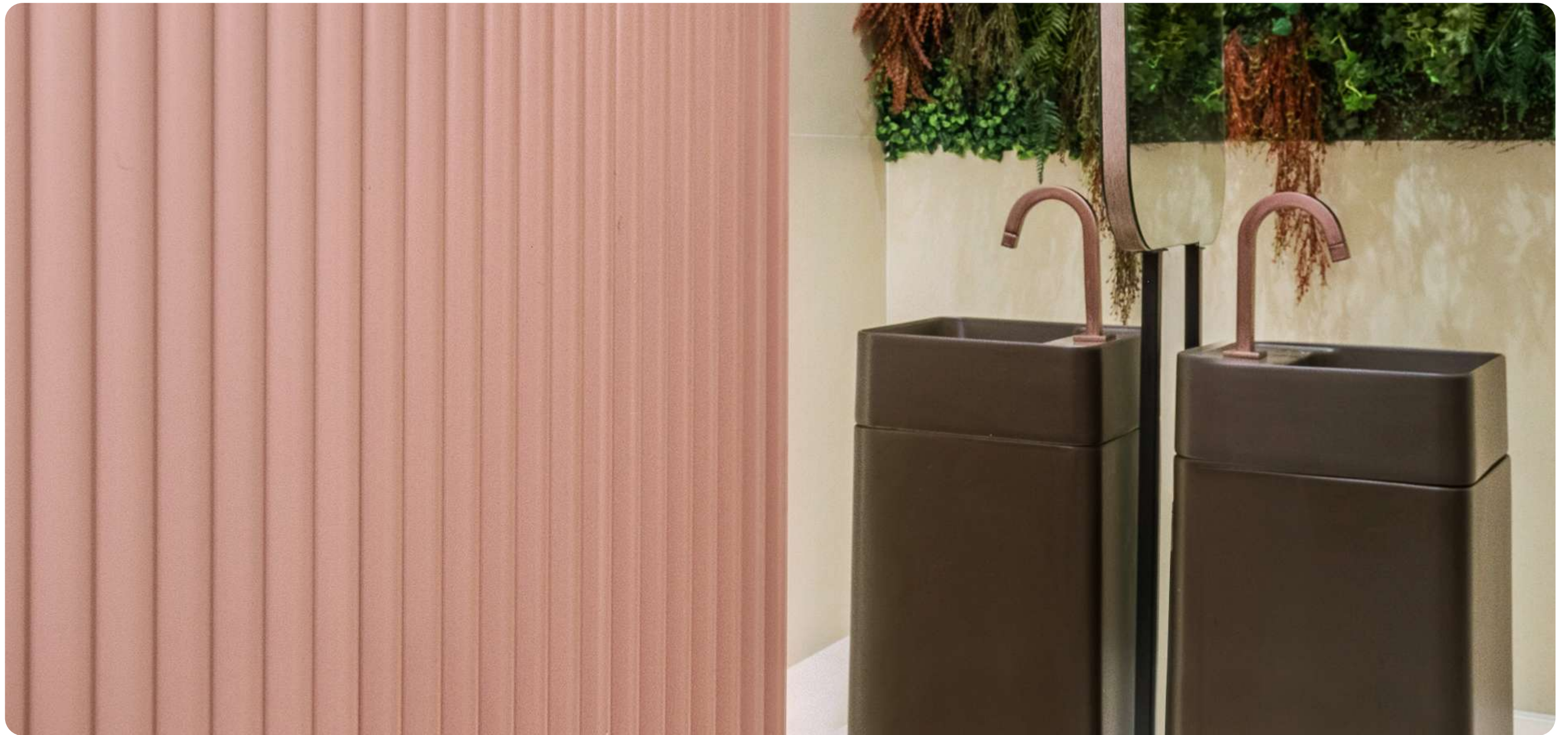



Restaurante Villon - Kelly Wearstler

ARKWOOD PB BLUE

São Francisco, Califórnia





ARKOWOOD PBG

REVESTIMENTOS DE MADEIRA ECOLÓGICA PARA INTERIORES



Dimensões

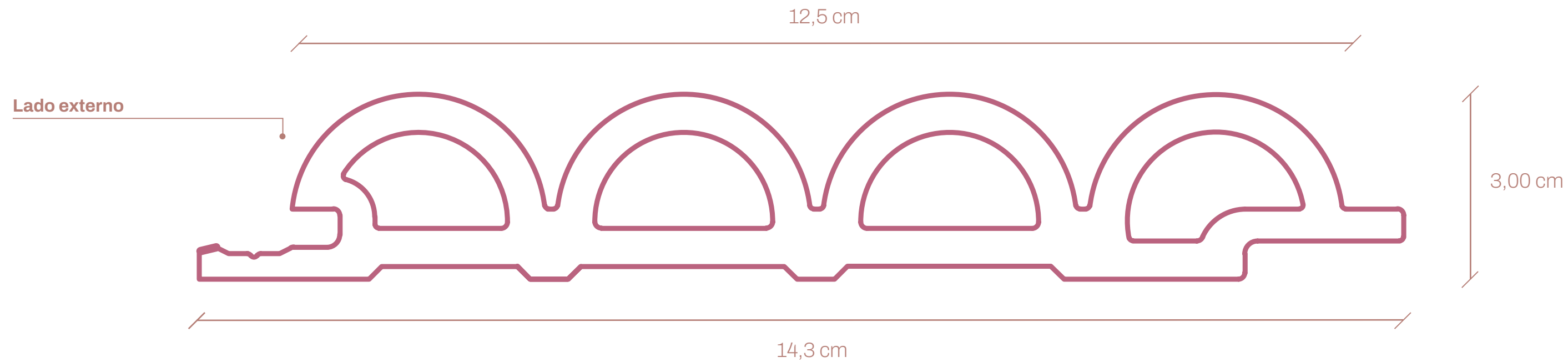

R\$552/M²

Comprimento entre 2,90m a 4,00m

ARKWOOD PBG

PALETA DE CORES



arkos

*CORES ESPECIAIS SOB ENCOMENDA
A PARTIR DE 60 METROS QUADRADOS

ARKWOOD PBG

PROJETOS



Restaurante Bao Hut - DLUX Studio
ARKWOOD PB GREY
São Paulo, SP



















ARKOWOOD PP

REVESTIMENTOS DE MADEIRA ECOLÓGICA PARA INTERIORES



Dimensões

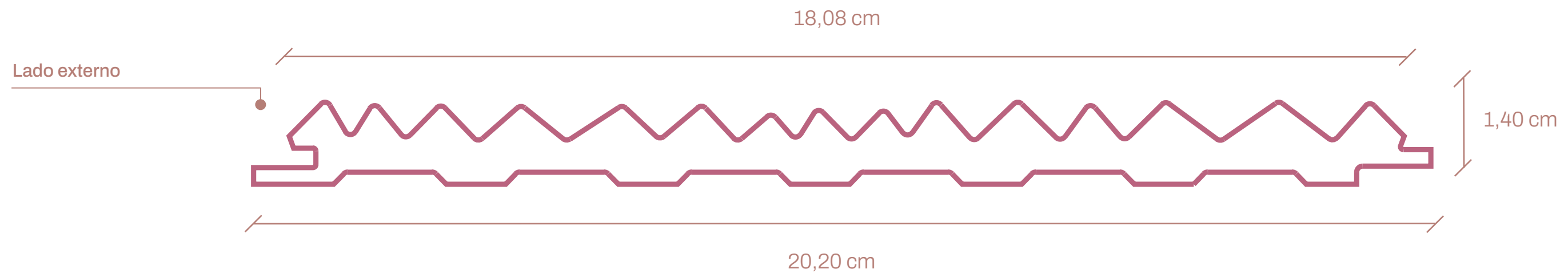

R\$661/M²

Comprimento entre 2,90m a 4,60m

ARKWOOD PP

ARKWOOD PP

PALETA DE CORES



arkos

*CORES ESPECIAIS SOB ENCOMENDA
A PARTIR DE 60 METROS QUADRADOS

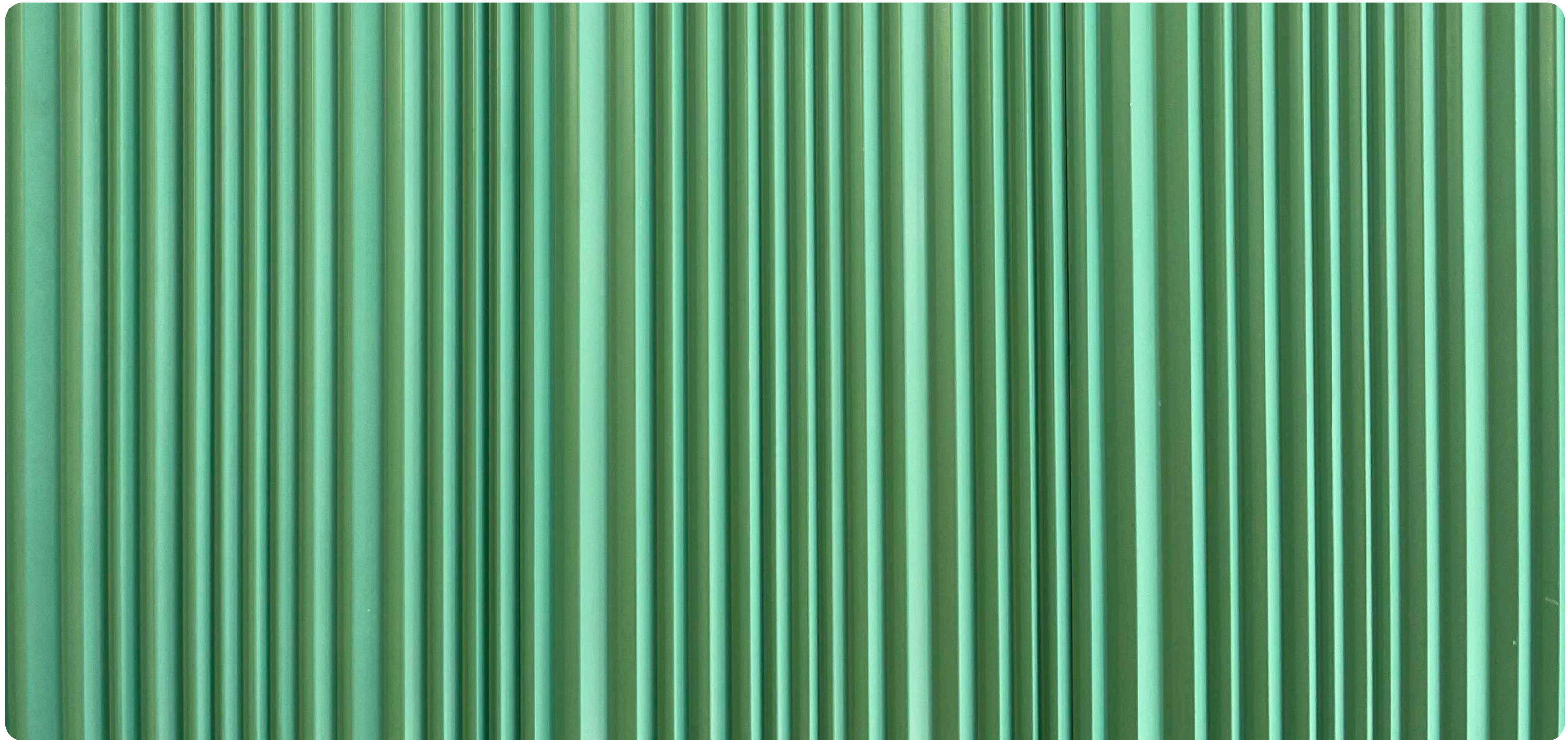

arkWOOD PL

REVESTIMENTOS DE MADEIRA ECOLÓGICA PARA INTERIORES

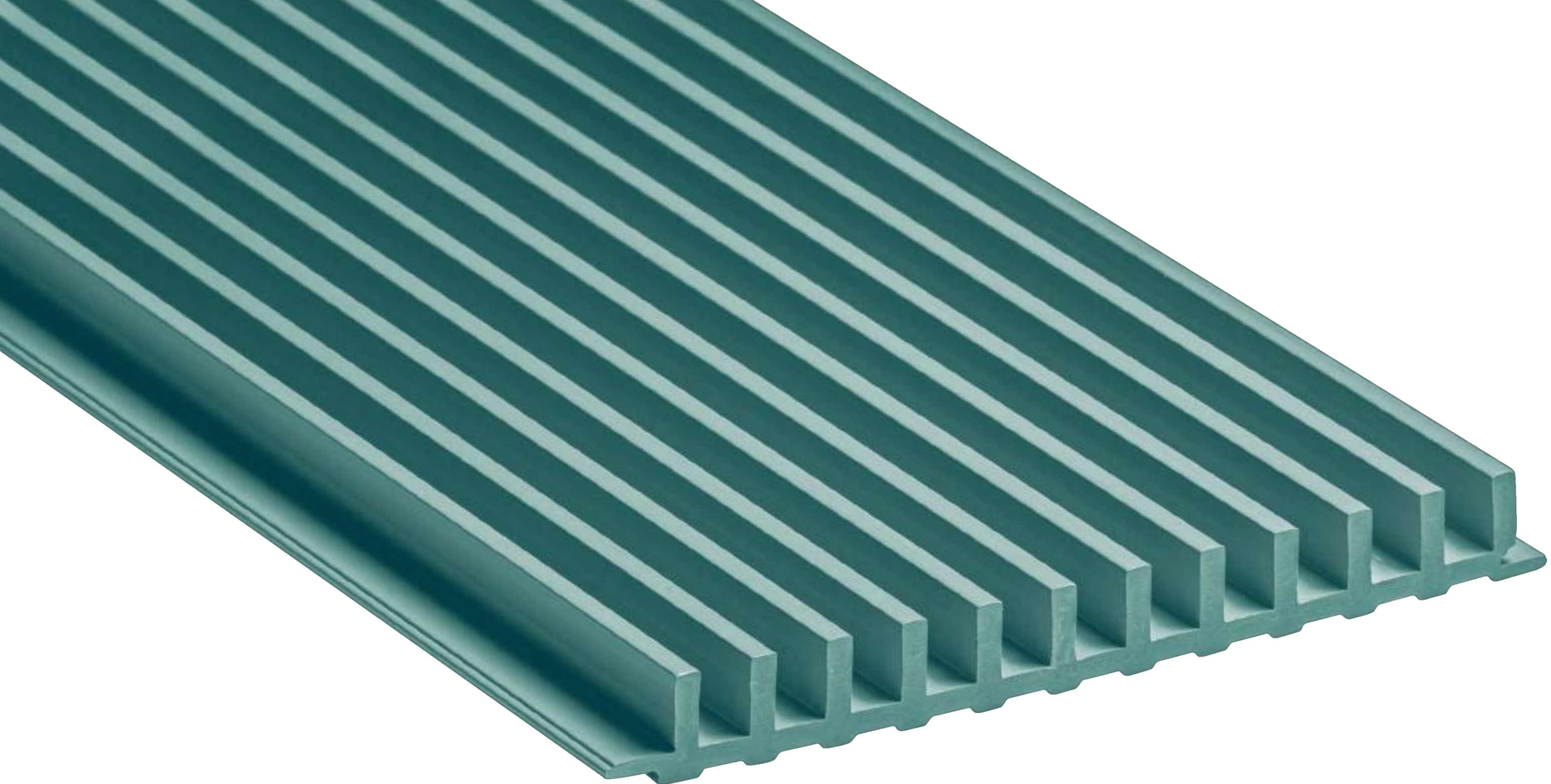

Dimensões

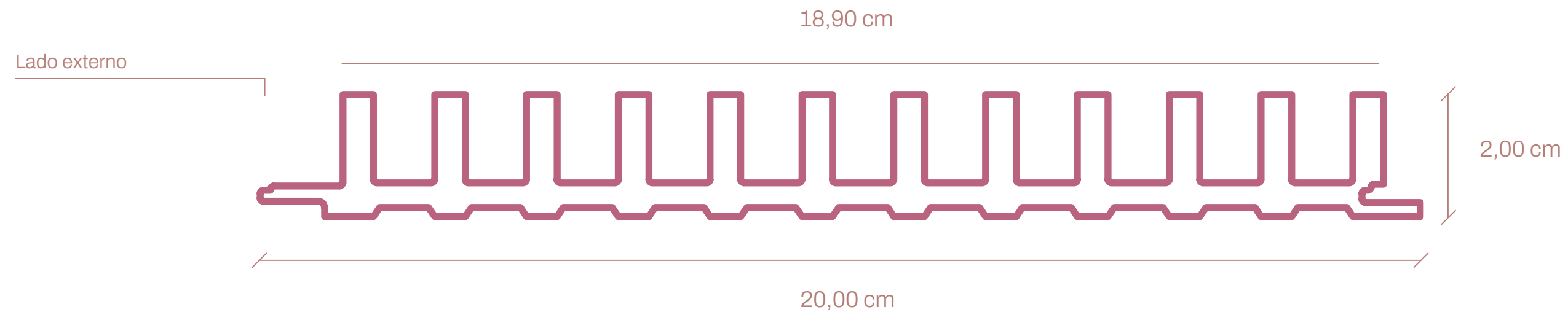

R\$419/M²

Comprimento entre 2,90m a 4,60m

ARKWOOD PL

ARKWOOD PL

PALETA DE CORES

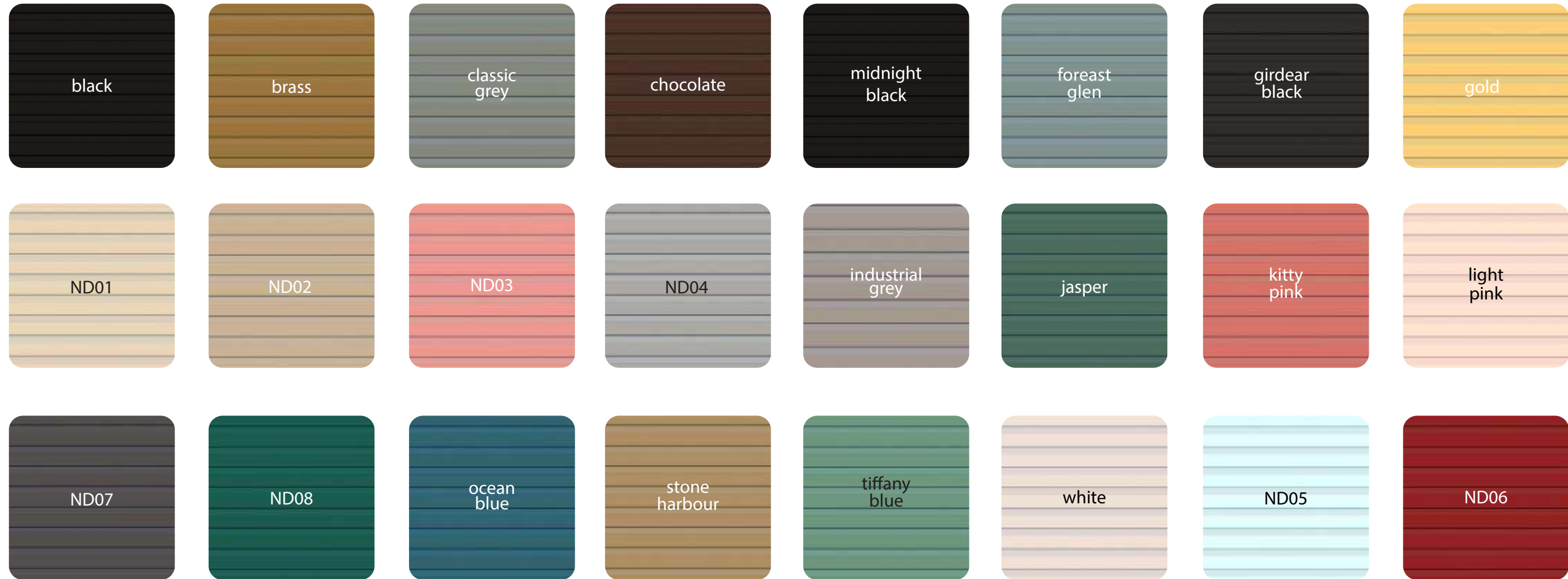

arkos

*CORES ESPECIAIS SOB ENCOMENDA
A PARTIR DE 60 METROS QUADRADOS

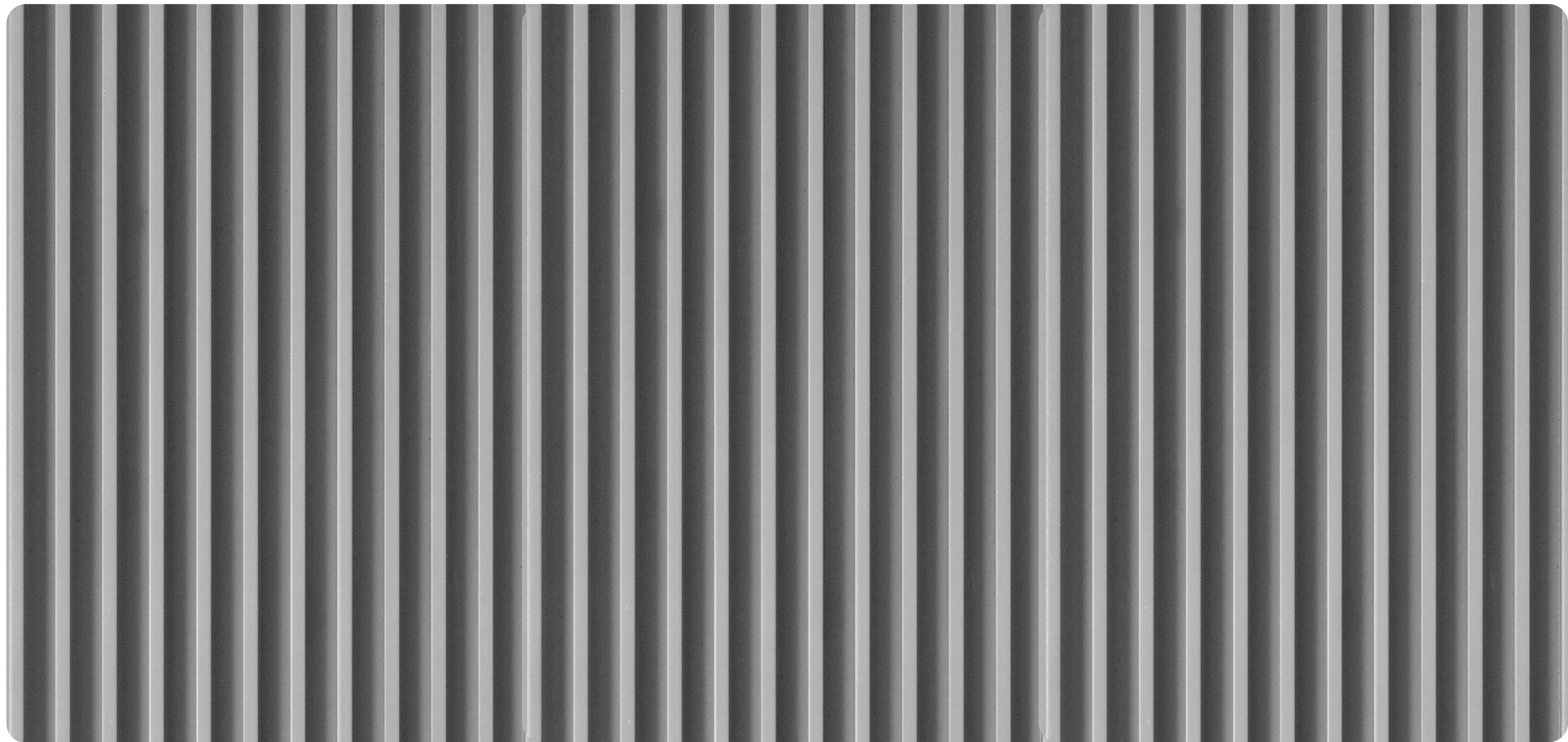

ARKWOOD P

INSTALAÇÃO

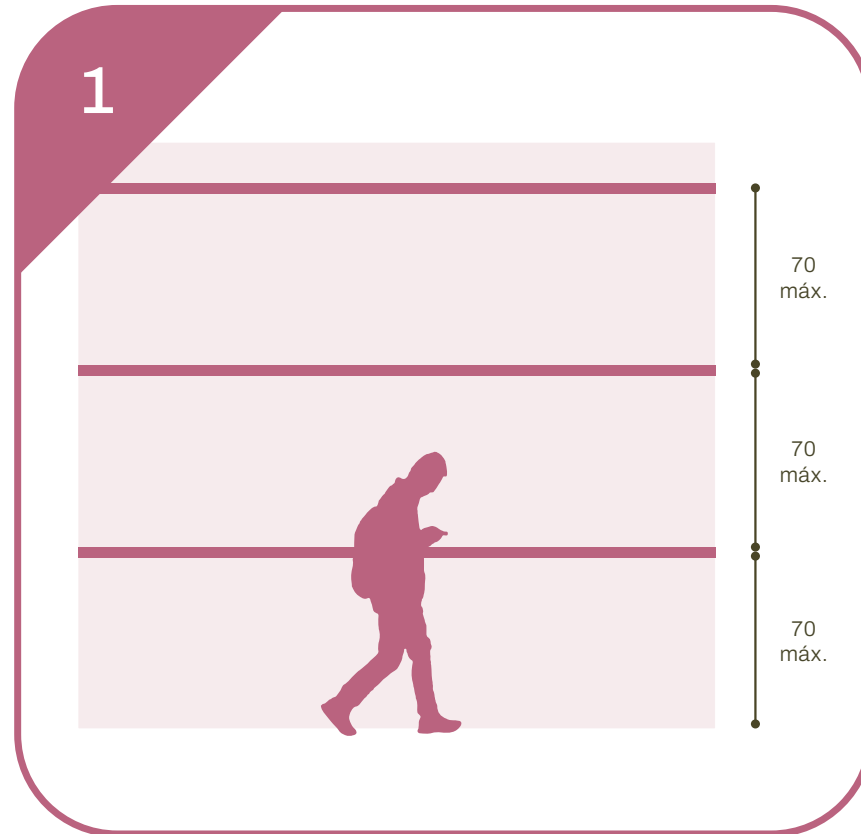

APLICAÇÃO DO PRODUTO TENDO EM CONTA UM DISTANCIAMENTO ENTRE APOIOS DE 70CM E FURO CONFORME AS MEDIDAS E APLICAÇÃO DAS BUCHAS SEGUNDO A SUPERFÍCIE DE INSTALAÇÃO.

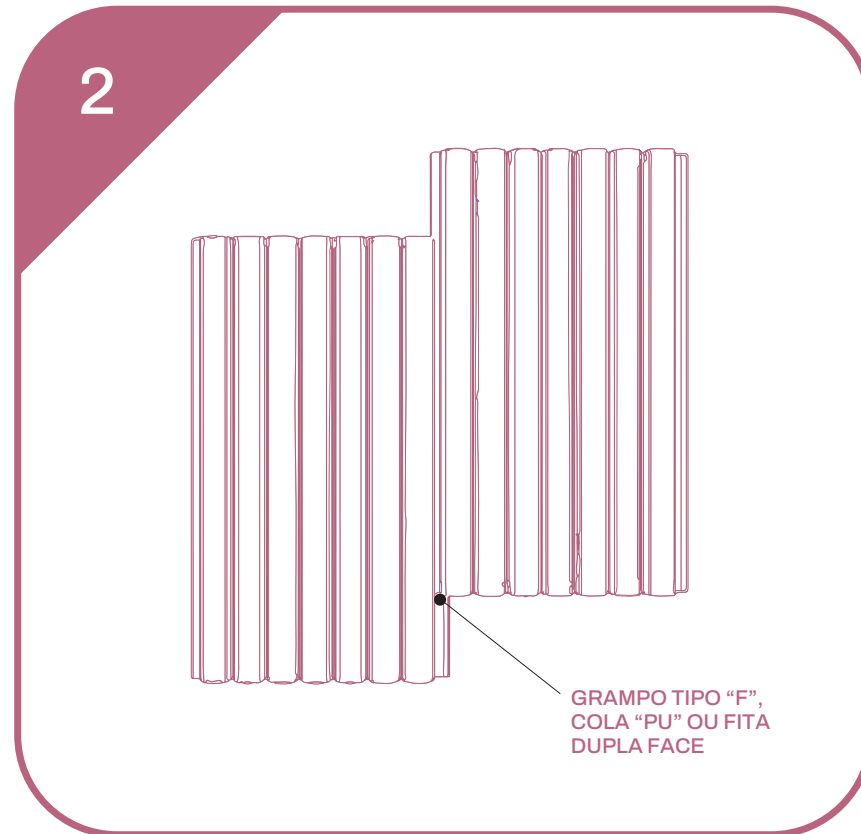

PARAFUSAÇÃO DOS PERFIS DE SUPORTE E APLICAÇÃO DO PRIMEIRO PAINEL COM FITA DUPLA FACE OU COLA "PU".

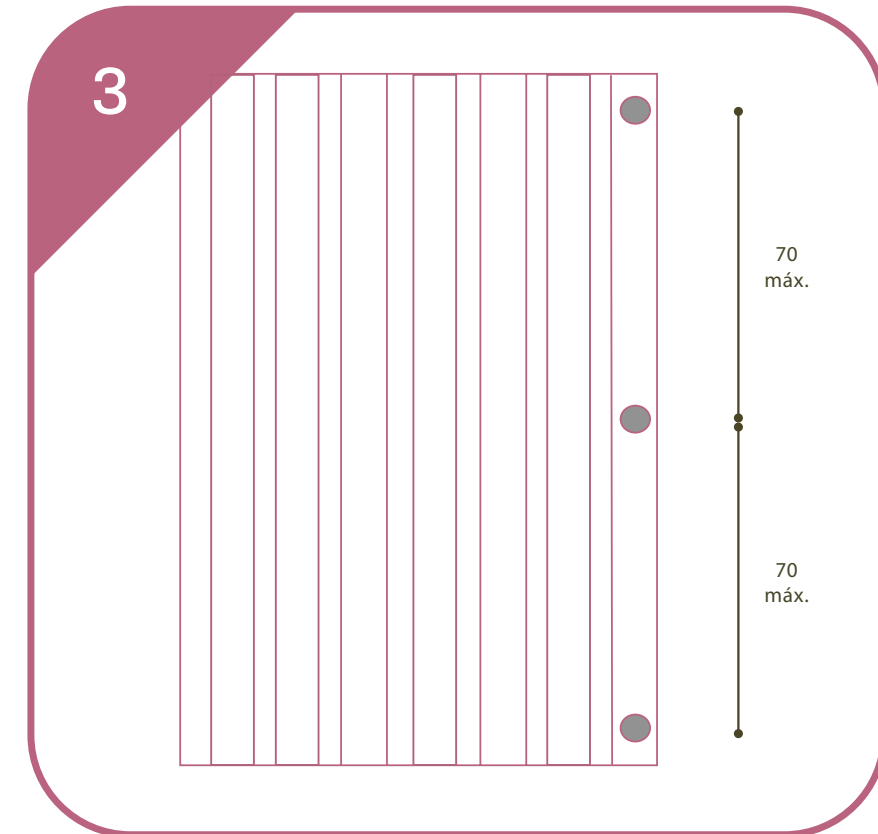

FIXAÇÃO DE CADA RÉGUA NOS PERFIS COM GRAMPEADOR PNEUMÁTICO E GRAMPOS TIPO "F", E ENCAIXE DAS MESMAS EM SEQUÊNCIA, FORMANDO O PAINEL RIPADO.



VIDEO DE INSTALAÇÃO

Não inclui elementos acessórios e mão-de-obra.

ARKWOOD P

INSTALAÇÃO



1

APLICAÇÃO DO PRODUTO TENDO EM CONTA UM DISTANCIAMENTO ENTRE APOIOS DE 70CM E FURO CONFORME AS MEDIDAS E APLICAÇÃO DAS BUCHAS SEGUNDO A SUPERFÍCIE DE INSTALAÇÃO.



2

PARAFUSAÇÃO DOS PERFIS DE SUPORTE E APLICAÇÃO DO PRIMEIRO PAINEL COM FITA DUPLA FACE OU COLA "PU".



3

FIXAÇÃO DE CADA RÉGUA NOS PERFIS COM GRAMPEADOR PNEUMÁTICO E GRAMPOS TIPO "F", E ENCAIXE DAS MESMAS EM SEQUÊNCIA, FORMANDO O PAINEL RIPADO.



VIDEO DE
INSTALAÇÃO

Não inclui elementos acessórios e mão-de-obra.



ENCAIXE DE PAINÉIS

INSTALAÇÃO SOBRE OSB, FIBROCIMENTO, TRIPLAX E DRYWALL (Não inclui elementos acessórios e mão-de-obra)

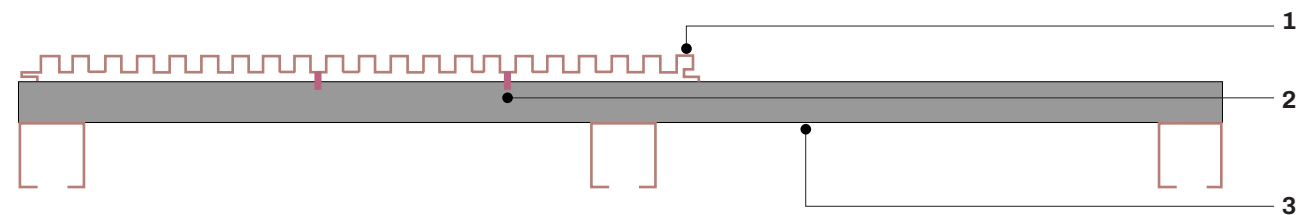

1 - Arkowood P

2 - Grampo tipo "F"

3 - OSB, Fibrocimento, Triplax ou Drywall

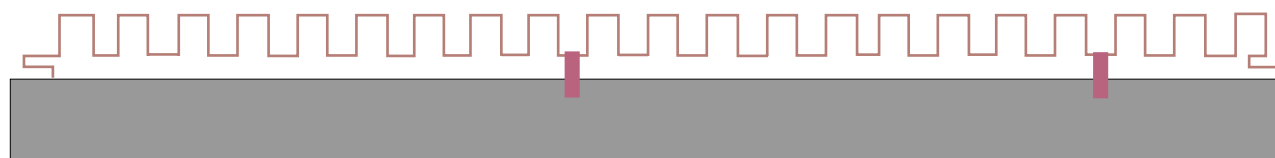

Instalação deve SEMPRE começar pela parte "macho" do material;

Use uma fita de espuma estrutural de 1"x3 mm ou similar para fixar a peça inicial;

Evite a exposição do grampo

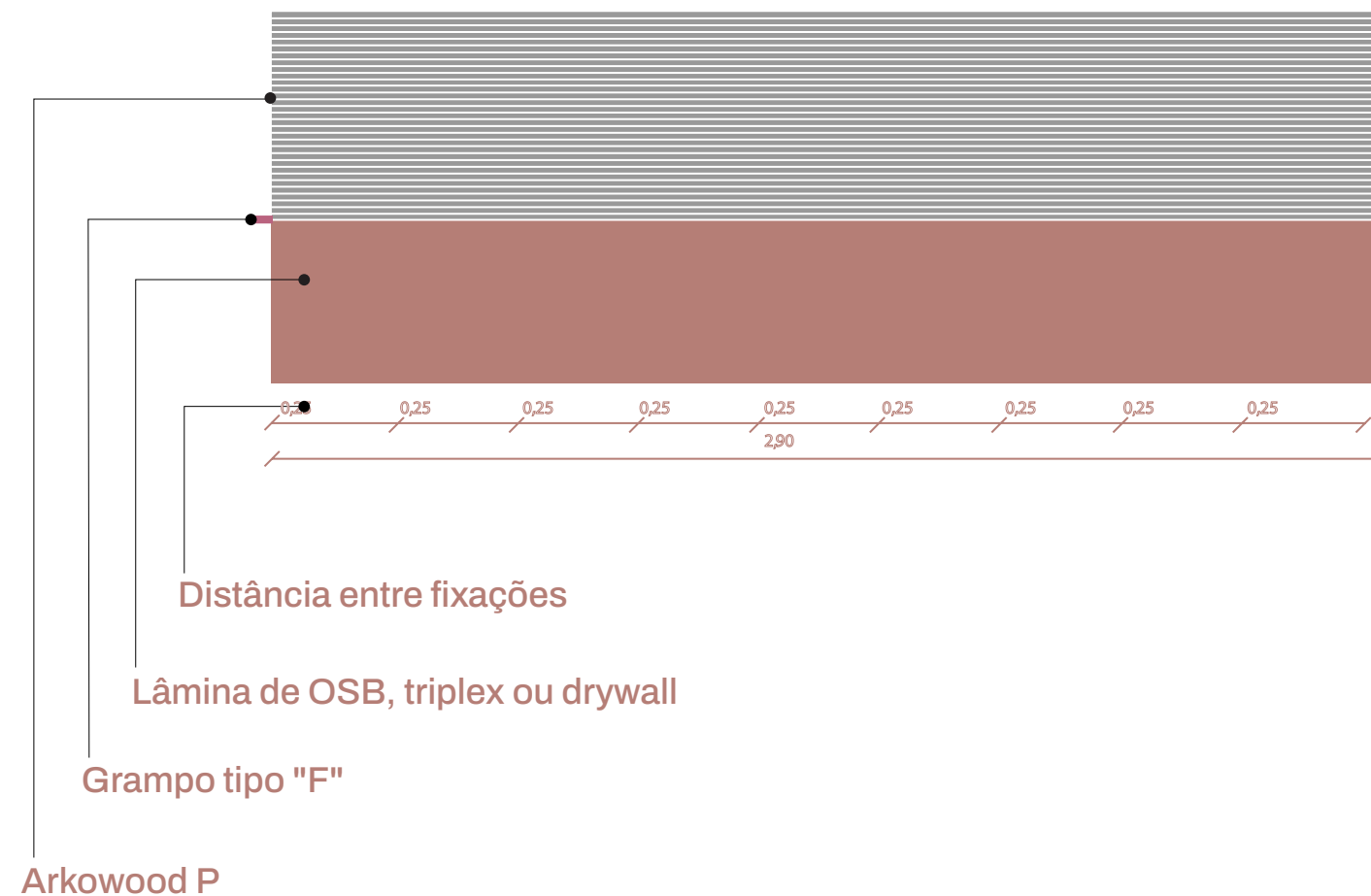

INSTALAÇÃO SOBRE ALVENARIA (Não inclui elementos acessórios e mão-de-obra)

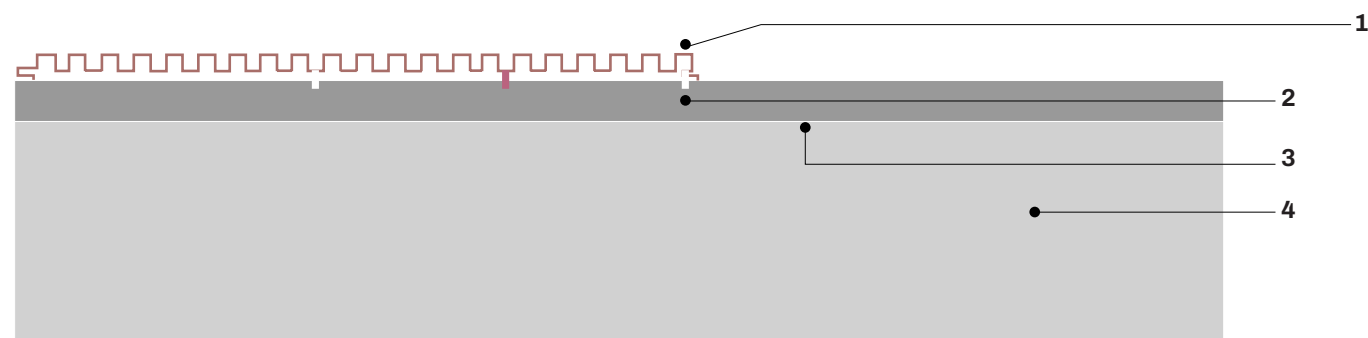

- 1 - Ripado de OSB esp. 09mm x2"
- 2 - Grampo tipo "F"
- 3 - OSB, Fibrocimento, Triplax ou Drywall
- 4 - Alvenaria

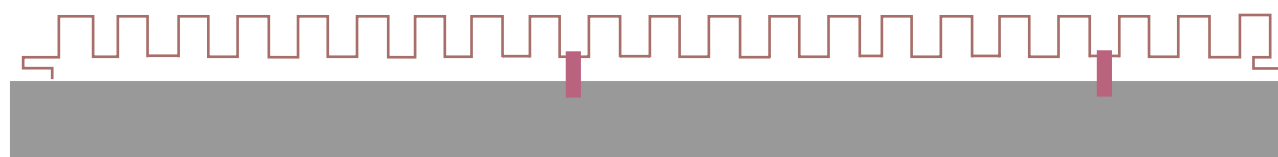

Instalação deve **SEMPRE** começar pela parte do Arkowood P

Use uma fita de espuma estrutural de 1"x3 mm ou similar para fixar a peça inicial;

Evite a exposição do grampo

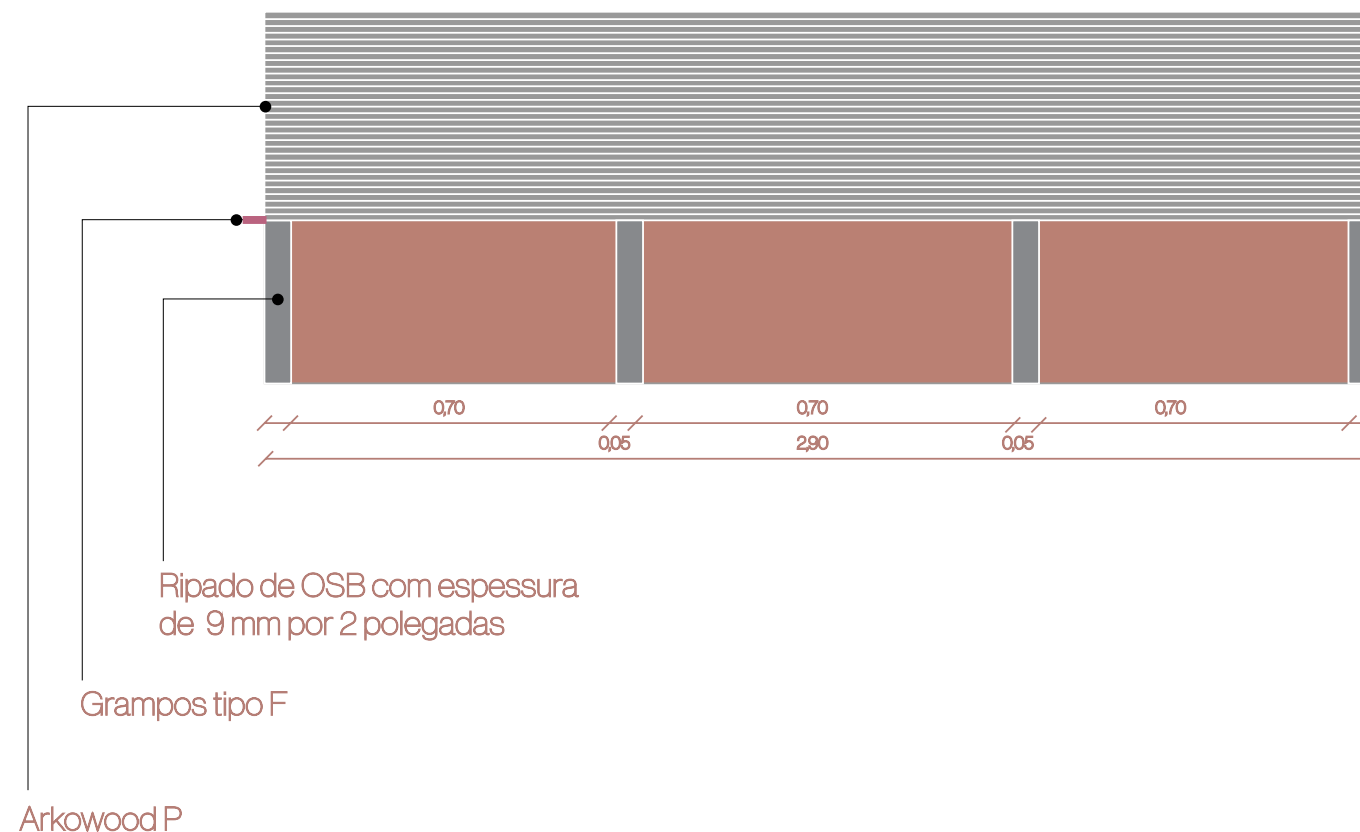

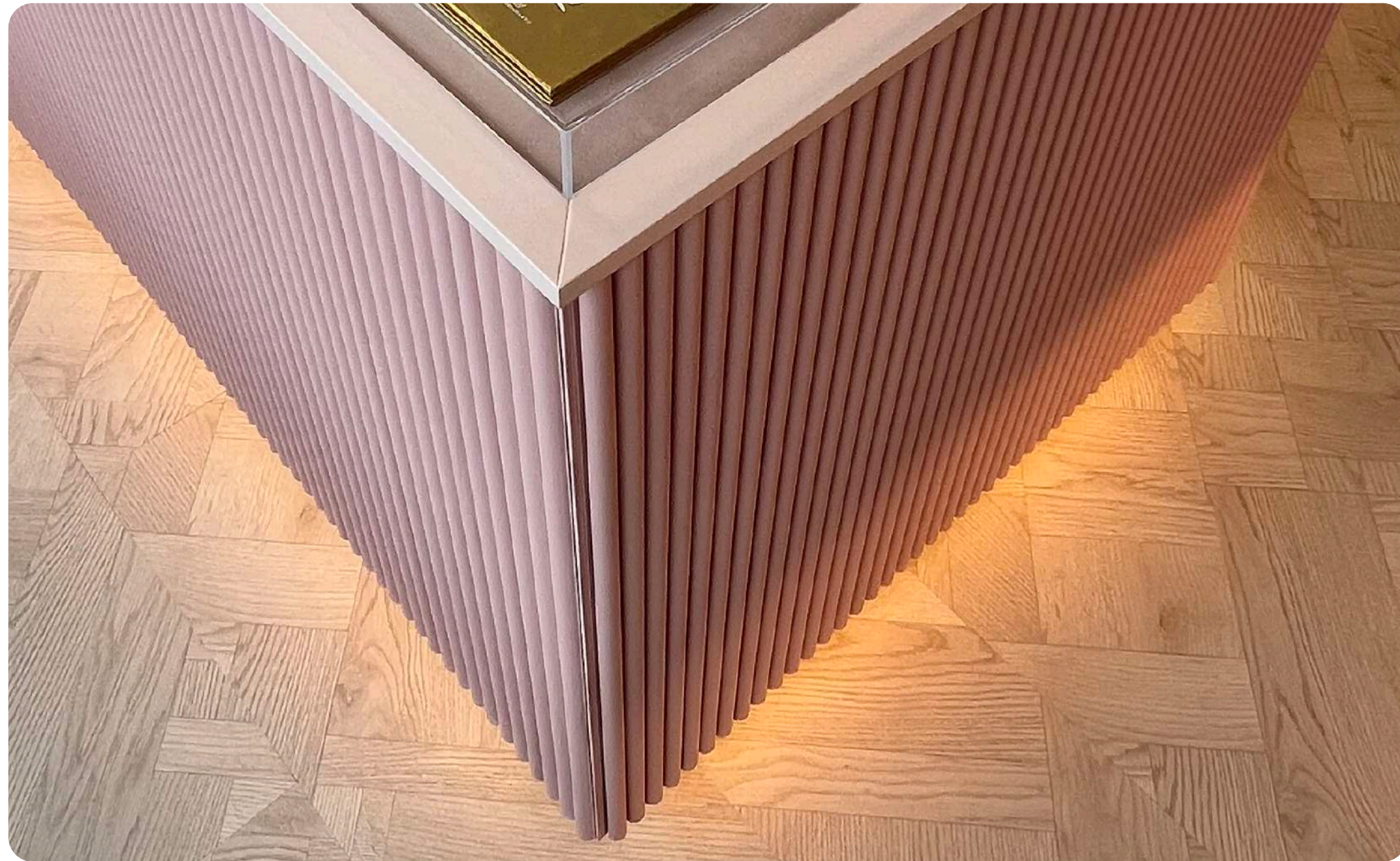

ARKWOOD P

ENCONTROS - ESQUINAS

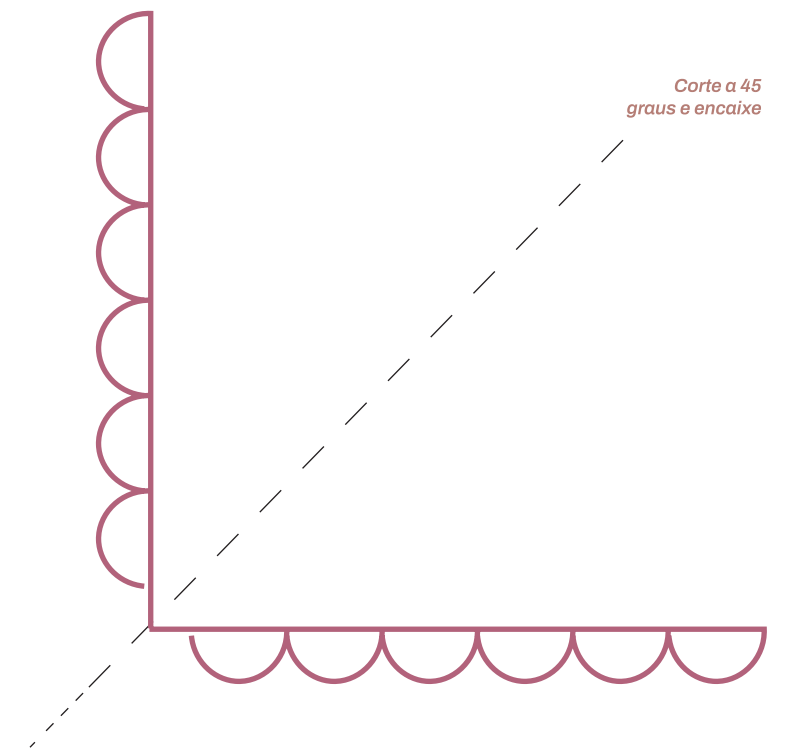

ARKWOOD P

FERRAMENTAS DE INSTALAÇÃO



CORTADOR DE DISCO CIRCULAR



DISCO CIRCULAR PARA MADEIRA



PARAFUSADEIRA COM PARAFUSO
PERFURANTE DE CABEÇA CHATA

ARKOWOOD P

RECOMENDAÇÕES DE USO E MANUTENÇÃO

Não bata no material durante a descarga e segure-o muito bem durante o transporte, armazene o produto em paletes ou bases firmes, uniformes e rígidas, não exceda 40 unidades na vertical ao empilhar e não descanse elementos pesados sobre o produto armazenado.

Proteja-o dos elementos com materiais não translúcidos: polietileno preto, papelão ou materiais similares, garantindo fluxo contínuo de ar. Se houver contaminação, limpe imediatamente removendo qualquer substância derramada, não utilize produtos abrasivos e não esfregue, molhe-o com água quente e seque com um pano macio. Pode ser lavado à pressão, com uma recomendação de pressão máxima de 1100 PSI, sempre adote as medidas de segurança necessárias e evite danos ao material.

AMANTES DE BOA ARQUITETURA

arkos

www.arkosbrasil.com.br

 arkosbrasil



 +5511971196692