

arkos

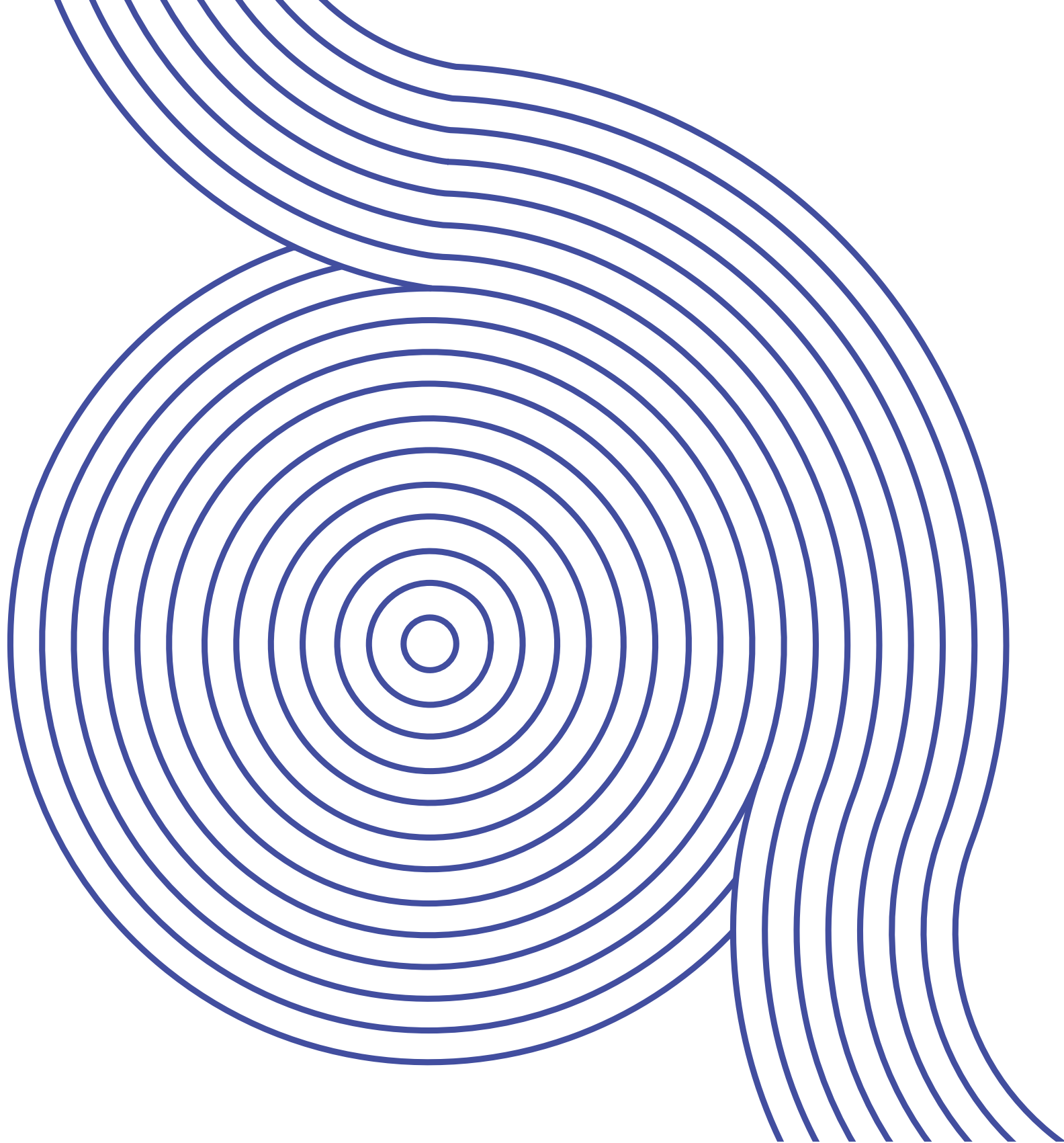



arkowood ER

BRISES CIRCULARES COMPOSTOS DE MADEIRA
ECOLÓGICA PARA EXTERIORES E INTERIORES



Características

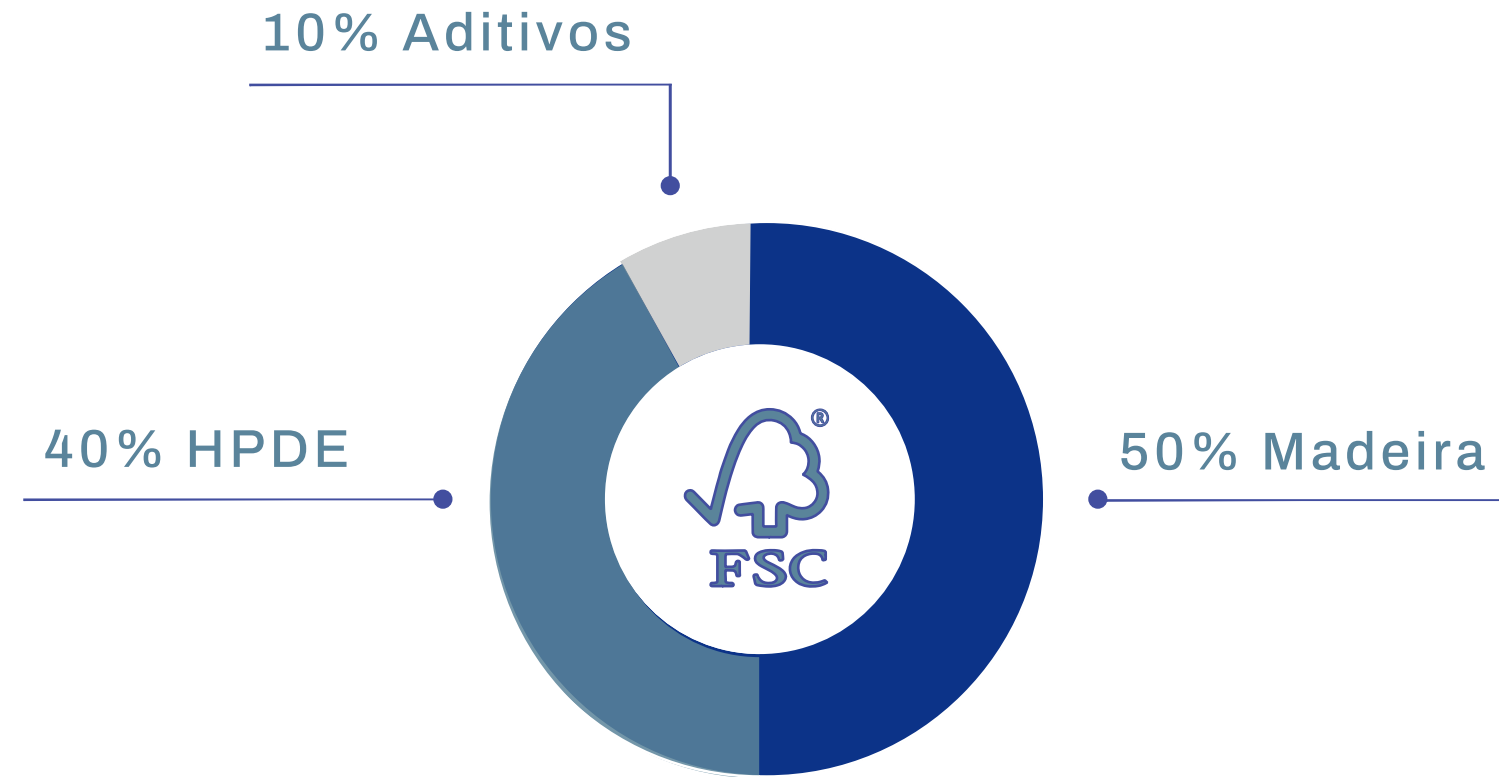

Brises circulares compostos de madeira ecológica de segunda geração, HDPE e aditivos, certificado pelo selo FSC de responsabilidade ambiental, desenhados para aplicação em áreas externas graças à tecnologia de proteção UV, que garante a estabilidade cromática do produto durante toda a sua vida útil.



Características

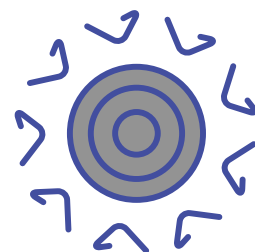

Proteção UV



Alta durabilidade



Aplicável em todos os tipos de clima

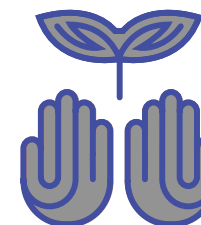

Responsabilidade ambiental



Fácil instalação

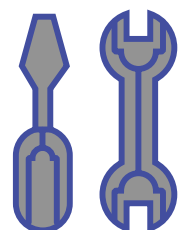

Não requer manutenção

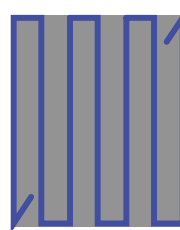

Produto sustentável

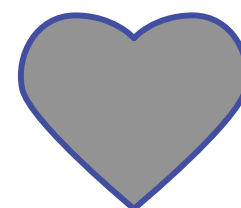

Vida útil de mais de 20 anos



Garantia de 10 anos

Seções disponíveis

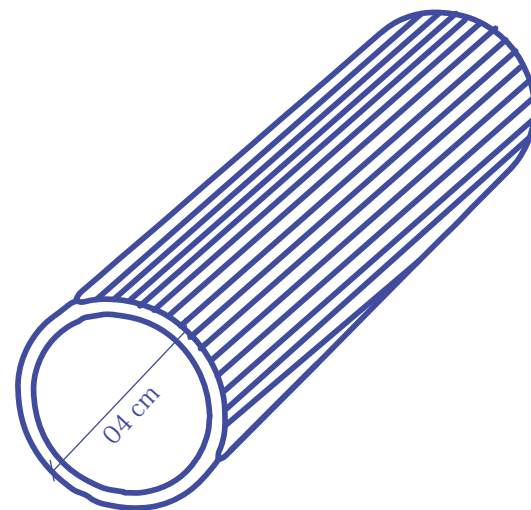

ER 04
a partir de
R\$ 29,00/ Metro Linear

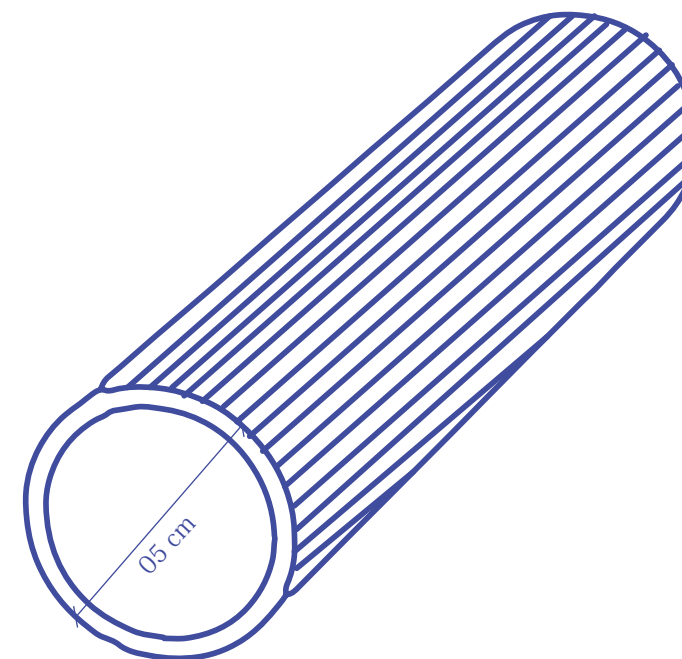

ER 05
a partir de
R\$ 36,00/Metro Linear

Comprimento de régua: de 2,90m até 4,00m

ARKWOOD ER

PALETA DE CORES



teka



preto



nogal



branco



ipê



areia



cinza



creme



walnut

A escolha da cor não altera o preço final

ARKOS

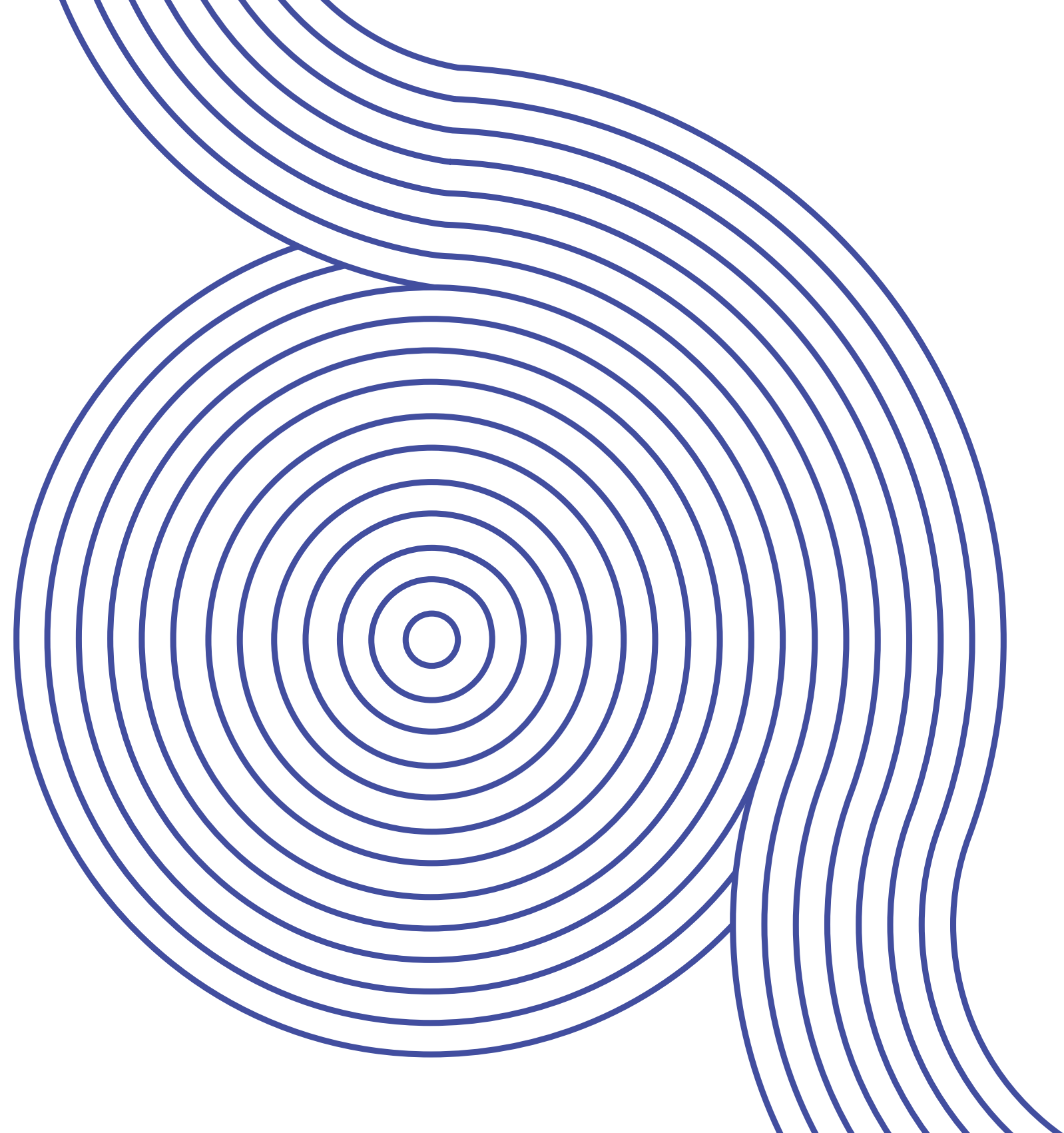

ARKWOOD ER

PROJETOS
INSTITUCIONAIS













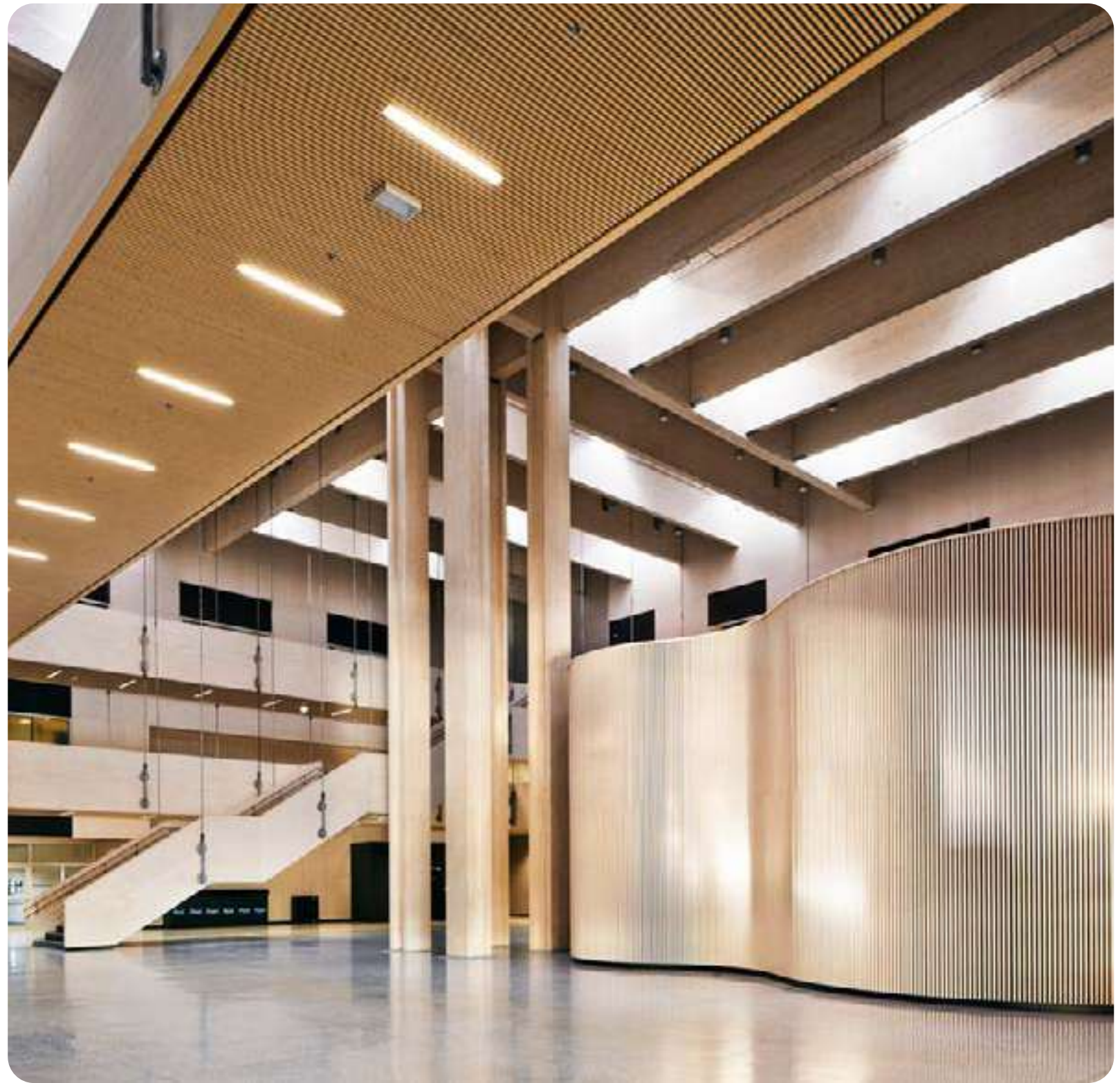



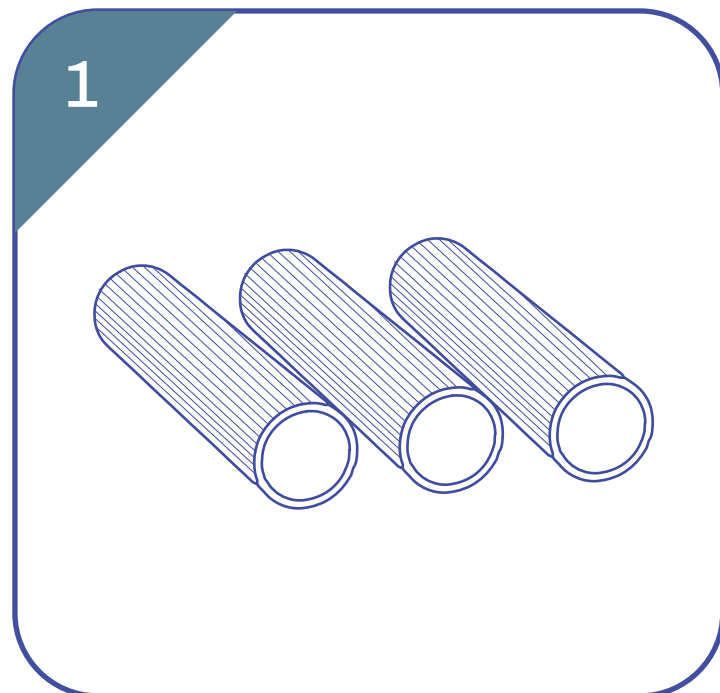

AJUSTE DA MODULAÇÃO

ALINHAR OS PERFIS DE ACORDO COM A FRENTE / ESPAÇAMENTO PROJETADOS.

O MATERIAL PODE SER TRABALHADO COM QUALQUER MODULAÇÃO.

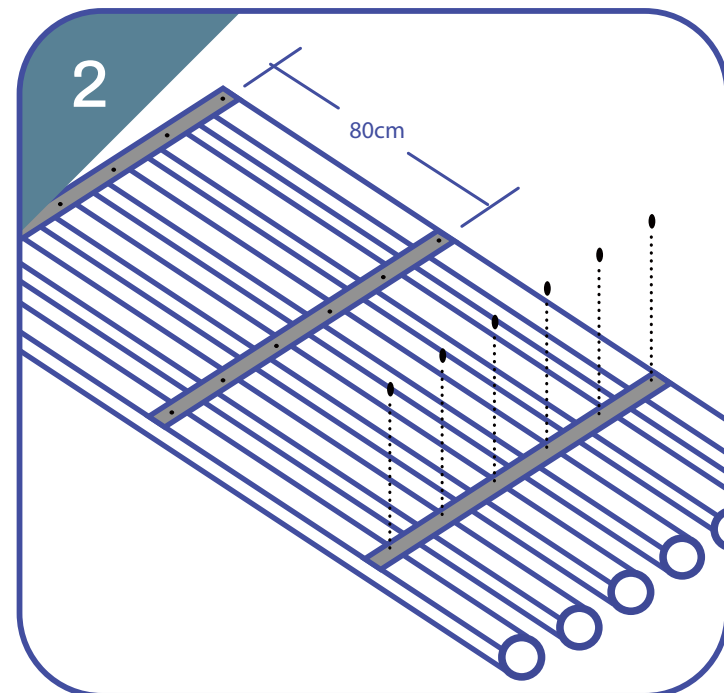

FIXAÇÃO EM BARRA CHATA METÁLICA

PARAFUSAR OS RIPADOS PELA PARTE DE TRÁS EM UMA BARRA CHATA DE ALUMÍNIO COM PARAFUSOS AUTO ATARRAXANTES

O ARKOWOOD ER PRECISA DE UMA ESTRUTURA AUXILIAR METÁLICA A NO MÍNIMO A CADA 80CM

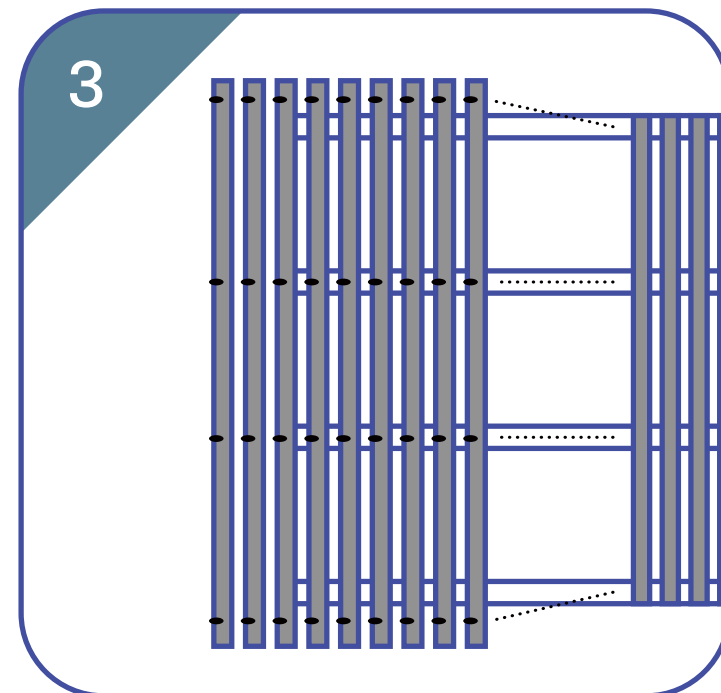

FIXAÇÃO DA BARRA CHATA NA ESQUADRIA / ALVENARIA

FIXAR A BARRA CHATA COM PARAFUSOS AUTO BROCANTE NA ESTRUTURA METÁLICA.

OS PARAFUSOS DEVEM SER FIXADOS NOS ESPAÇOS ENTRE OS RIPADOS,

PARA FIXAÇÃO DA BARRA CHATA EM ALVENARIAS RECOMENDA-SE O NIVELAMENTO DA SUPERFÍCIE.

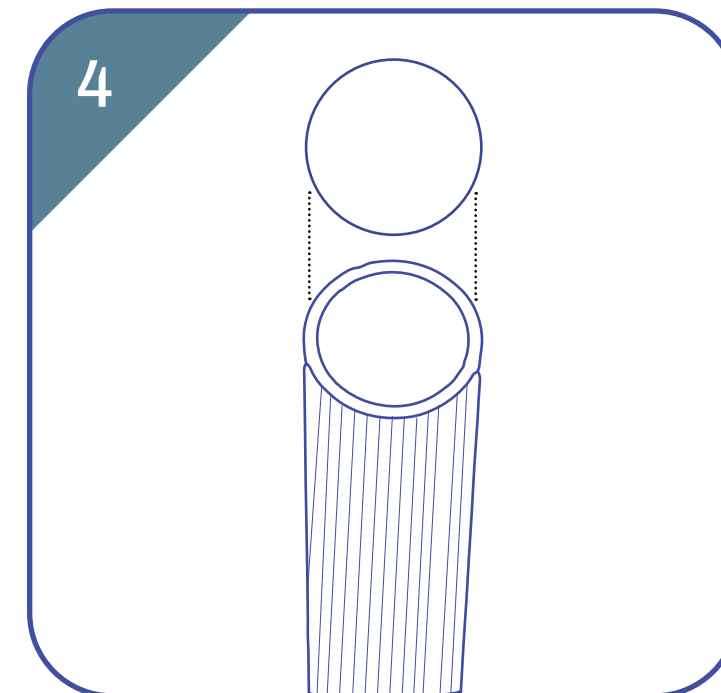

FIXAÇÃO DE TAMPAS

FIXAR TAMPAS DO ARKOWOOD PARA FECHAMENTO DOS RIPADOS – OPCIONAL

TAMPAS DEVEM SER ORÇADAS A PARTE.

ARKOWOOD ER
FIXAÇÃO

Instalação e estrutura auxiliar não estão inclusas



ARKWOOD ER

ARMAZENAMENTO, DESLOCAMENTO E MANUTENÇÃO

Não bata no material durante a descarga e segure o muito bem durante o transporte.

Armazene o produto em paletes ou bases firmes, uniformes e rígidas.

Não exceda 40 unidades na vertical ao empilhar.

Não descanse elementos pesados sobre o produto armazenado.

Proteja o dos elementos com materiais não translúcidos: polietileno preto, papelão ou materiais similares, garantindo fluxo contínuo de ar.

Se houver contaminação, limpe imediatamente removendo qualquer substância derramada; não utilize produtos abrasivos; não esfregue: molhe o com água quente e seque o com um pano macio.

Pode ser lavado à pressão, com uma recomendação de pressão máxima de 1100 PSI.

Sempre adote as medidas de segurança necessárias e evite danos ao material.

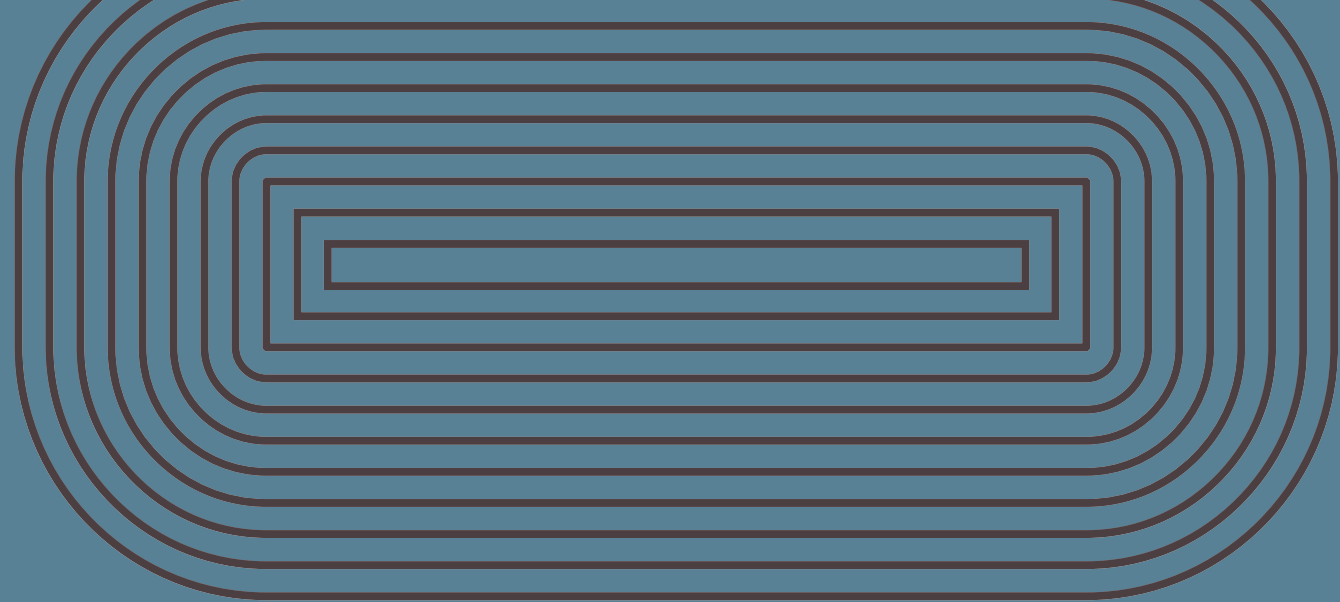

AMANTES DE BOA ARQUITETURA





arkos



www.arkosbrasil.com.br

 arkosbrasil



 +5511971196692